

Features

- Wide Supply Voltage: 4.5V to 17V
- Output Voltage Range: 0.76 V to 7 V
- Internal Power FET: 150mΩ and 80mΩ
- High-Efficiency Synchronous-Mode Operation
- 650 kHz Switching Frequency
- Internal Light Load Power-Save Mode for High Efficiency at Light Load
- Internal Soft-Start
- Over-Current Protection and Hiccup
- Thermal Shutdown
- Small outline package TSOT23-6, SOT523
- -40°C to 125°C Operation Ambient Temperature Range

Applications

- Digital TV Power Supply
- Digital Set Top box (STB)
- Video Surveillance
- Networking Home Terminal
- General Purpose

Description

The TPP2020 is a simple, easy to use, 2-A output, synchronous, step-down, switch-mode converter with internal power MOSFETs.

The TPP2020 provides a fast-transient response and supports both low equivalent series resistance (ESR) output polymer capacitors and ceramic capacitors with no external compensation components.

TPP2020 offers a very compact solution to achieve a 2A continuous output current over a wide input supply range, with excellent load and line regulation.

Protection features include over-current protection and thermal shutdown.

The devices are available in a 6-pin TSOT23-6 package, and specified from -40°C to 125°C of ambient temperature

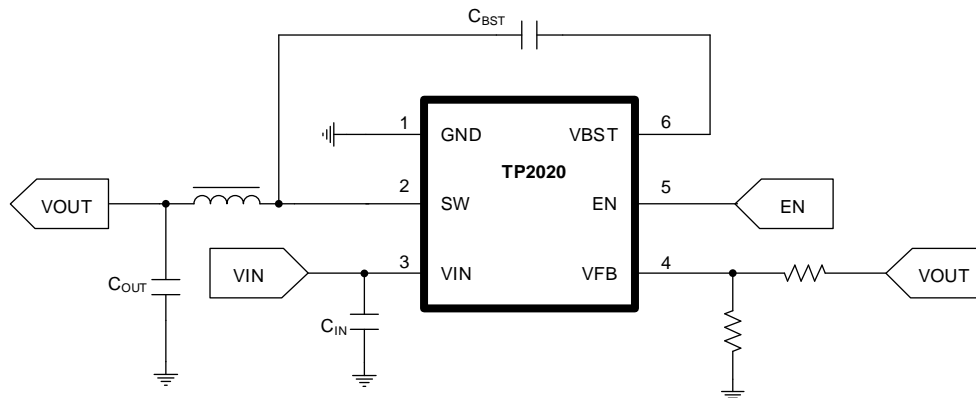

Table of Contents

| | |
|---|----|
| Features | 1 |
| Applications | 1 |
| Description | 1 |
| Revision History | 3 |
| Pin Configuration | 3 |
| Order Information | 3 |
| Absolute Maximum Ratings ^{Note 1} | 3 |
| ESD Rating | 4 |
| Thermal Information | 4 |
| Electrical Characteristics | 5 |
| Typical Performance Characteristics | 6 |
| Detailed Description | 10 |
| Overview | 10 |
| Functional Block Diagram | 10 |
| Feature Description | 10 |
| Constant On-Time Control | 10 |
| Improved Light-Load Mode | 10 |
| Soft-Start with Pre-Biased Capability | 10 |
| Over Current Protection | 11 |
| Output Undervoltage Hiccup Protection | 11 |
| Undervoltage Lockout (UVLO) Protection | 11 |
| Over Temperature Shutdown | 11 |
| Application | 11 |
| Application Information | 11 |
| Typical Application | 11 |
| Component Selection | 12 |
| Layout Recommendations | 13 |
| Tape and Reel Information | 14 |
| Package Outline Dimensions | 15 |
| TSOT23-6 | 15 |

Revision History

| Date | Revision | Notes |
|-----------|----------|---------|
| 2020/2/19 | 1.0 | Release |
| | | |
| | | |

Pin Configuration

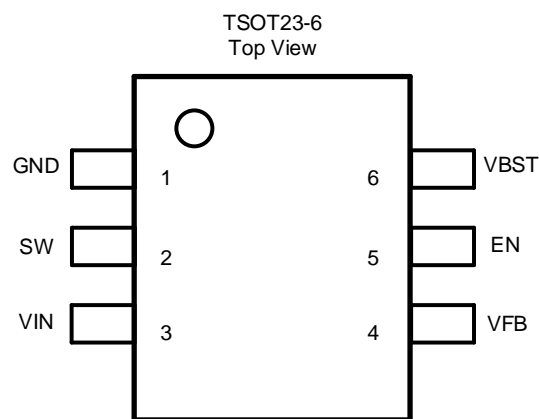

Figure 1 Pin function

| PIN | | DESCRIPTION |
|------|-----|--|
| NAME | NO. | |
| GND | 1 | Ground pin. Power and controller circuit ground. Use star connection to GND pin with good contact |
| SW | 2 | Switching node pin. Voltage switching between high-side FET and low-side FET. Connect 2.2- μ H between SW and OUT. |
| VIN | 3 | Supply input pin. Connect decoupling 2 \times 10- μ F and 1 \times 0.1- μ F capacitors between VIN and GND pins. |
| VFB | 4 | Voltage feedback pin. Connect to output voltage with feedback resistor divider. |
| EN | 5 | Enable input. Active high. Internally weak pull-down resistors. |
| VBST | 6 | High-side MOSFET gate supply pin. Connect 0.1- μ F between VBST and SW pins. |

Order Information

| Order Number | Operating Temperature Range | Package | Marking Information | MSL | Transport Media, Quantity |
|--------------|-----------------------------|----------|---------------------|-----|---------------------------|
| TPP2020-6TR | -40 to 125°C | TSOT23-6 | 202 | 3 | Tape and Reel, 3000 |

Absolute Maximum Ratings ^{Note 1}

17-V Input, 2-A Synchronous Step-Down Voltage Regulator

| Parameters | Rating |
|--------------------------------------|------------------------|
| Supply Voltage, VIN | - 0.3 V to 18 V |
| Switching Node Voltage, SW | - 0.3 V to VIN + 0.3 V |
| Bootstrap Voltage, VBST – SW | - 0.3 V to 6.5 V |
| Feedback Voltage, FB | - 0.3 V to 6.5 V |
| Enable Input, EN | - 0.3 V to 18 V |
| Maximum Junction Temperature | 150°C |
| Operating Temperature Range | -40 to 125°C |
| Storage Temperature Range | -65 to 150°C |
| Lead Temperature (Soldering, 10 sec) | 260°C |

Note 1: Stresses beyond those listed under Absolute Maximum Ratings may cause permanent damage to the device. Exposure to any Absolute Maximum Rating condition for extended periods may affect device reliability and lifetime.

Note 2: The inputs are protected by ESD protection diodes to each power supply. If the input extends more than 300mV beyond the power supply, the input current should be limited to less than 10mA.

Note 3: A heat sink may be required to keep the junction temperature below the absolute maximum. This depends on the power supply voltage and how many amplifiers are shorted. Thermal resistance varies with the amount of PC board metal connected to the package. The specified values are for short traces connected to the leads.

ESD Rating

| Symbol | Parameter | Condition | Minimum Level | Unit |
|--------|--------------------------|------------------------|---------------|------|
| HBM | Human Body Model ESD | ANSI/ESDA/JEDEC JS-001 | 4 | kV |
| CDM | Charged Device Model ESD | ANSI/ESDA/JEDEC JS-002 | 1.5 | kV |

Thermal Information

| Package Type | θ_{JA} | θ_{JC} | Unit |
|--------------|---------------|---------------|------|
| TSOT23-6 | 100 | 67 | °C/W |

Electrical Characteristics

All test condition is $V_{IN} = 12V$, $T_A = -40^{\circ}C$ to $125^{\circ}C$, unless otherwise noted.

| Symbol | Parameter | Conditions | Min | Typ | Max | Unit |
|-----------------------------|-------------------------------|------------|------|-----|-----|-------------|
| Power Supply | | | | | | |
| V_{IN} | Supply Voltage Range | | 4.5 | | 17 | V |
| I_Q | Operating supply current | | | 500 | | μA |
| I_{QSD} | Shut down supply current | | | 1 | | μA |
| VFB Voltage | | | | | | |
| V_{FB} | V_{FB} Threshold Voltage | PFM mode | | 800 | | mV |
| | | PWM mode | 749 | 761 | 787 | mV |
| I_{VFB} | I_{VFB} Threshold Current | | -0.1 | 0 | 0.1 | μA |
| MOSFET | | | | | | |
| HS_{RDSON} | HS Switching On Resistance | | | 165 | | $m\Omega$ |
| LS_{RDSON} | LS Switching On Resistance | | | 75 | | $m\Omega$ |
| Current Limit | | | | | | |
| I_{Limit} | Current Limit | | | 3 | | A |
| Thermal Shutdown | | | | | | |
| T_{SD} | Thermal shut down temperature | | | 165 | | $^{\circ}C$ |
| | Thermal Hysteresis | | | 25 | | $^{\circ}C$ |
| Output Under Voltage | | | | | | |
| V_{OVP} | Output OVP threshold | | | 0.5 | | V |
| UVLO | | | | | | |
| UVLO | UVLO Threshold | | | 4 | | V |
| ON-Time Control | | | | | | |
| T_{ON} | On Time | | | 130 | | ns |
| T_{OFF} | Off Time | | | 200 | | ns |
| LOGIC THRESHOLD | | | | | | |
| V_{ENH} | EN high-level input voltage | | 2 | | | V |
| V_{ENL} | EN low-level input voltage | | | | 0.7 | V |
| R_{EN} | EN pin resistance to GND | | | 200 | | $k\Omega$ |

Typical Performance Characteristics

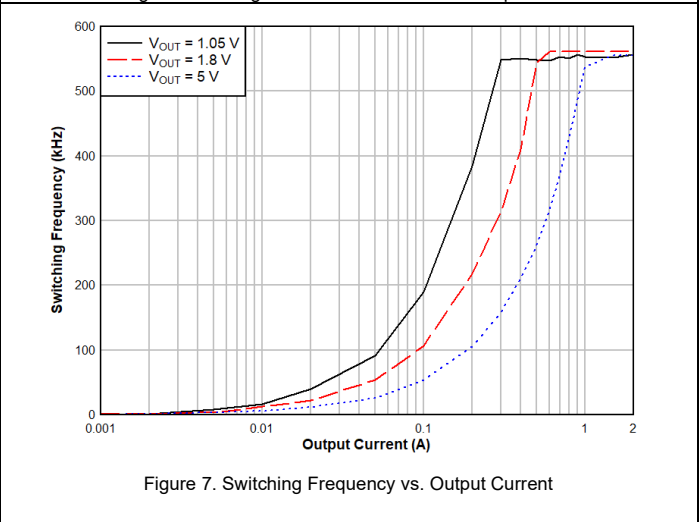
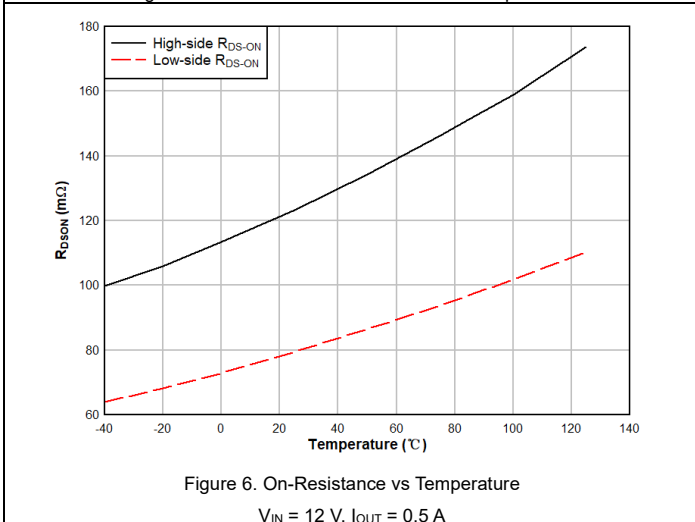
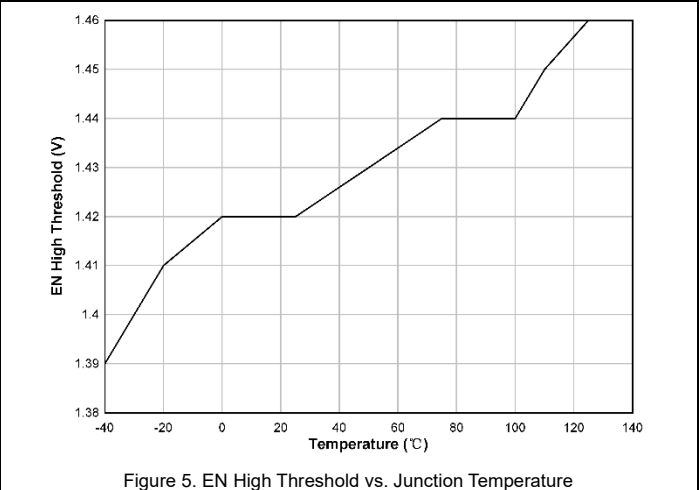
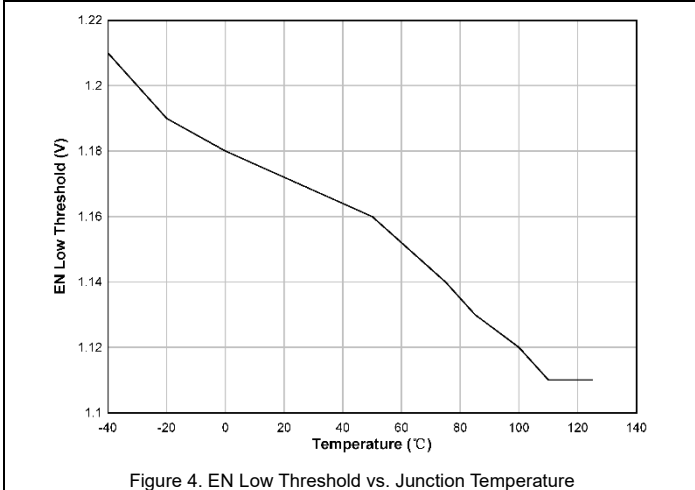
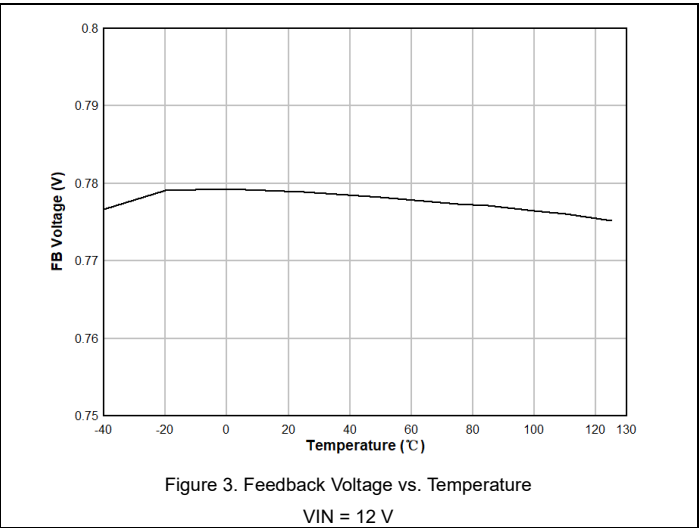
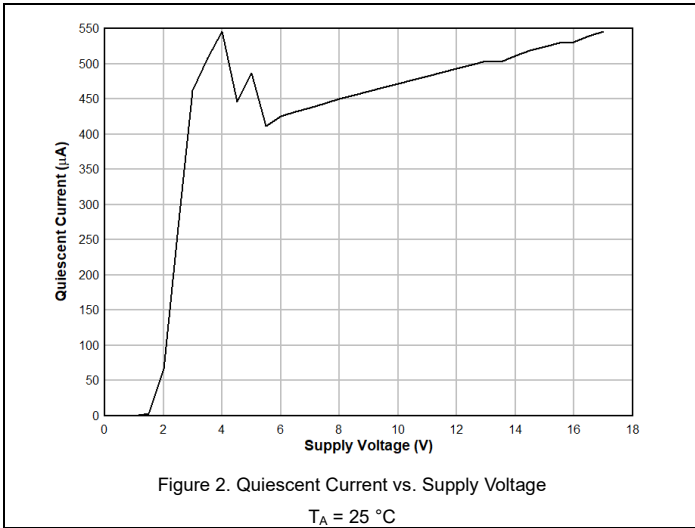

17-V Input, 2-A Synchronous Step-Down Voltage Regulator

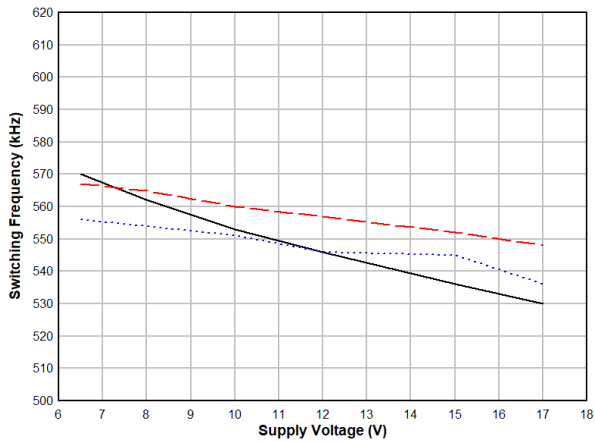

Figure 8. Switching Frequency vs. Supply Voltage

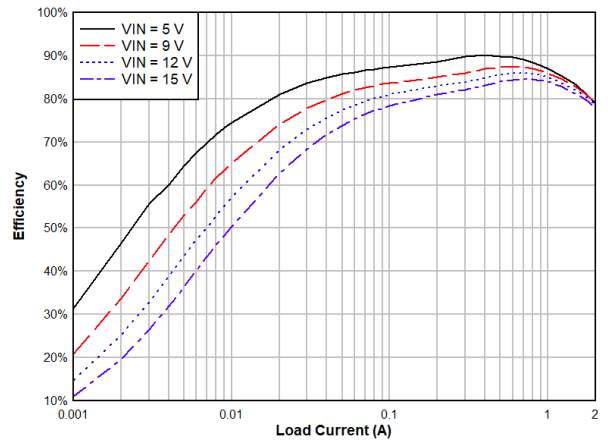

Figure 9. Efficiency vs. Output Current, $V_{OUT} = 1.05\text{ V}$, $L = 2.2\ \mu\text{H}$

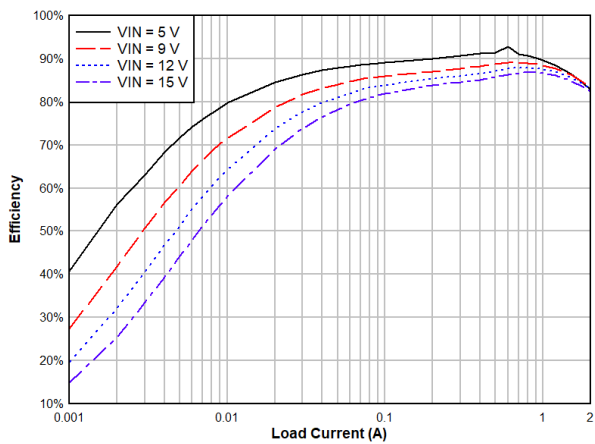

Figure 10. Efficiency vs. Output Current, $V_{OUT} = 1.5\text{ V}$, $L = 2.2\ \mu\text{H}$

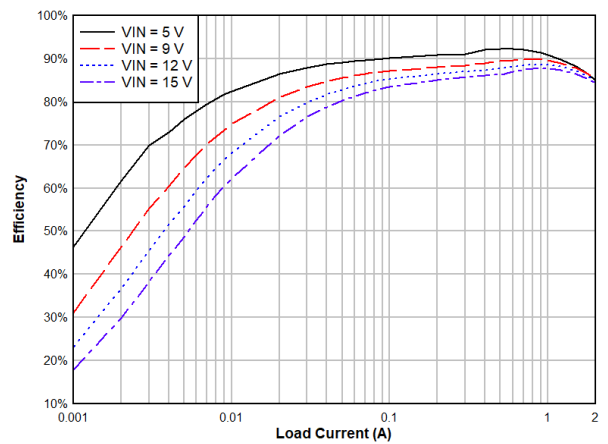

Figure 11. Efficiency vs. Output Current, $V_{OUT} = 1.8\text{ V}$, $L = 2.2\ \mu\text{H}$

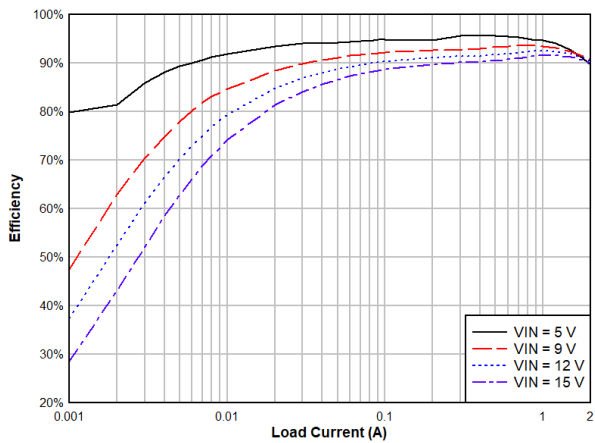

Figure 12. Efficiency vs. Output Current, $V_{OUT} = 3.3\text{ V}$, $L = 2.2\ \mu\text{H}$

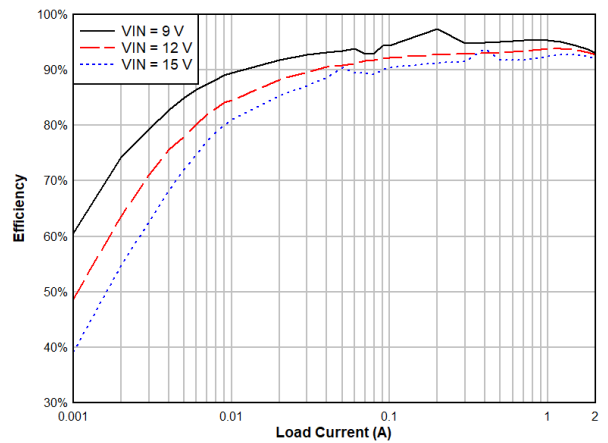

Figure 13. Efficiency vs. Output Current, $V_{OUT} = 5\text{ V}$, $L = 2.2\ \mu\text{H}$

17-V Input, 2-A Synchronous Step-Down Voltage Regulator

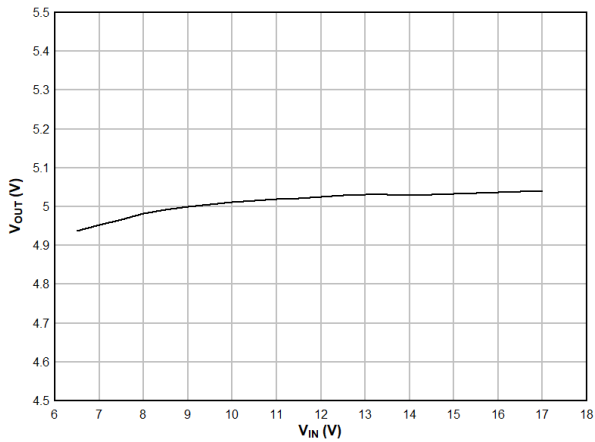

Figure 14. Line Regulation, I_{LOAD} = 1A

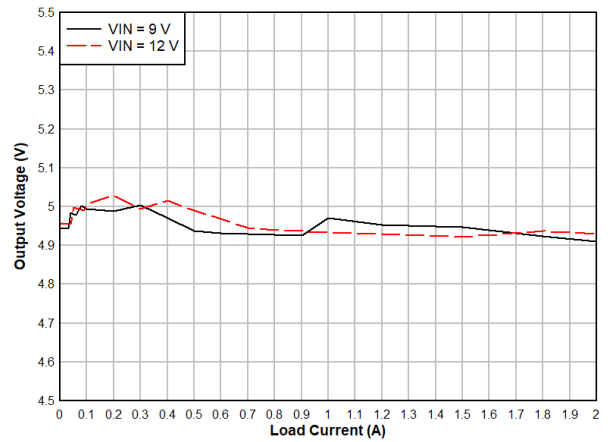

Figure 15. Load Transient, V_{OUT} = 5 V

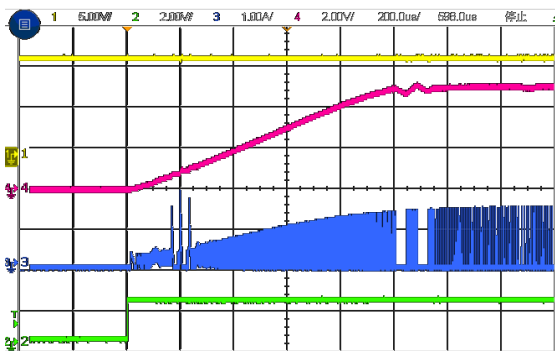

Figure 16. Start Up Curve
 V_{IN} = 12 V, V_{OUT} = 5 V, R_L = 27Ω
 CH1: V_{IN} CH2: V_{EN} CH3: I_{ind} CH4: V_{OUT}

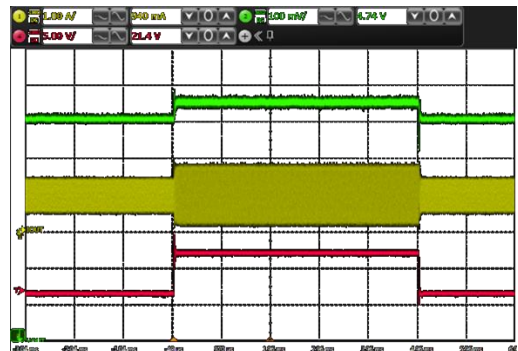

Figure 17. Line Transient, V_{OUT} = 5 V, I_L = 1 A
 CH1: I_{ind} CH2: V_{OUT} CH4: V_{IN}

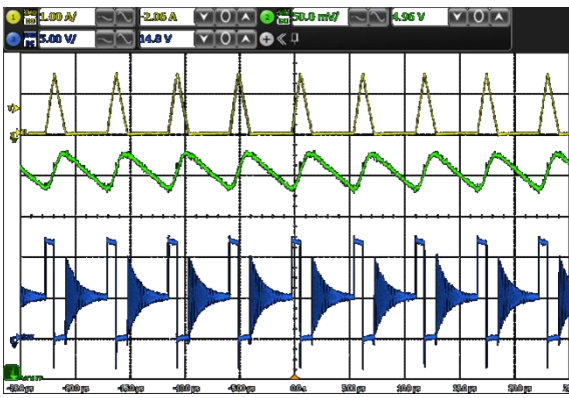

Figure 18. Output Voltage Ripple
 CH1: I_{ind} CH2: V_{OUT} CH3: SW
 V_{IN} = 12 V V_{OUT} = 5 V I_L = 0.25 A

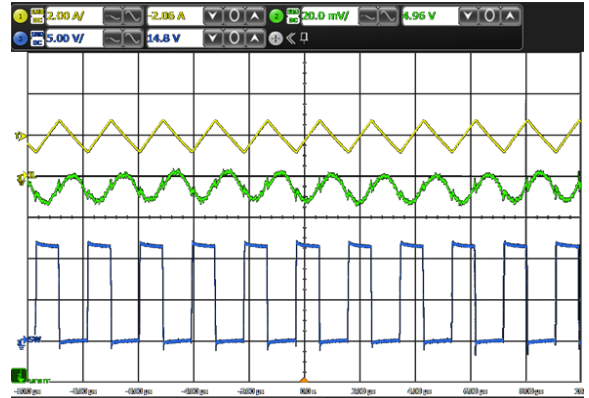

Figure 19. Output Voltage Ripple
 CH1: I_{ind} CH2: V_{OUT} CH3: SW
 V_{IN} = 12 V V_{OUT} = 5 V I_L = 2 A

17-V Input, 2-A Synchronous Step-Down Voltage Regulator

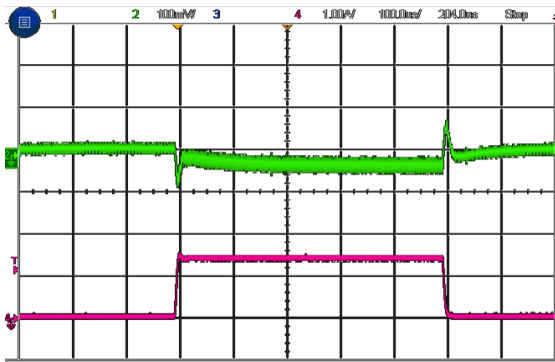

Figure 20. Load Transient
 CH2: V_{OUT} CH4: Load Current
 V_{IN} = 12 V V_{OUT} = 1 V I_L = 0.1 A to 1.5 A

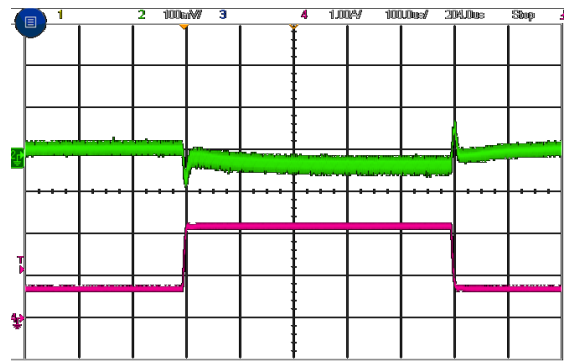

Figure 21. Load Transient
 CH2: V_{OUT} CH4: Load Current
 V_{IN} = 12 V V_{OUT} = 1 V I_L = 0.75 A to 2.25 A

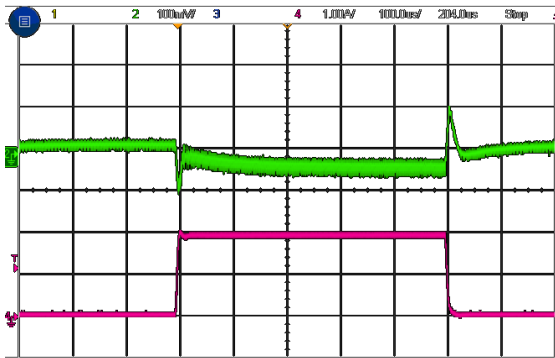

Figure 22. Load Transient
 CH2: V_{OUT} CH4: Load Current
 V_{IN} = 12 V V_{OUT} = 1 V I_L = 0.1 A to 1.5 A

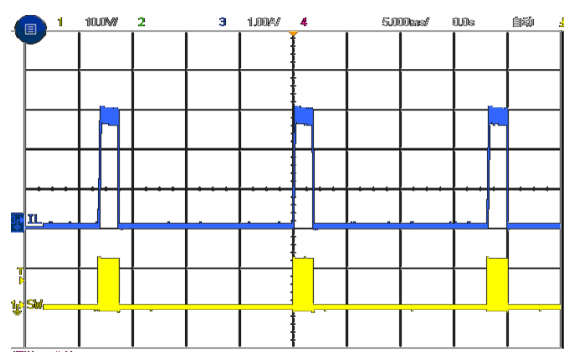

Figure 23. Over-current Hiccup Protection
 CH1: SW_T CH3: I_{ind}
 V_{IN} = 12 V

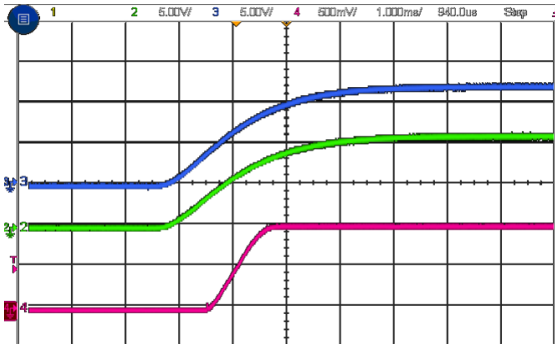

Figure 24. Power-Up Sequence
 CH2: EN CH3: V_{IN} CH4: V_{OUT}

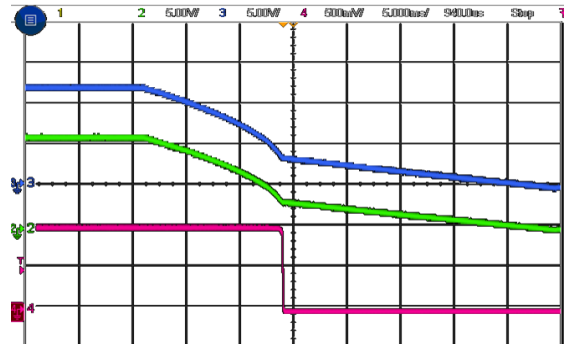

Figure 25. Power-Down Sequence
 CH2: EN CH3: V_{IN} CH4: V_{OUT}

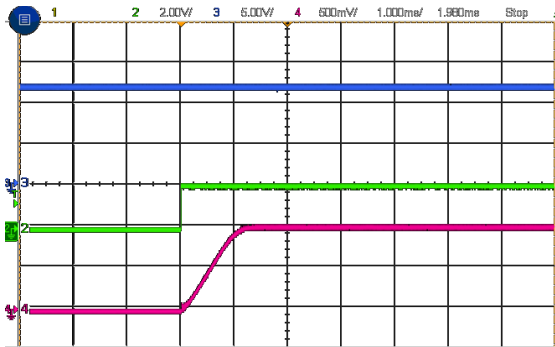

Figure 26. Power-Up Sequence with EN
 CH2: EN CH3: V_{IN} CH4: V_{OUT}

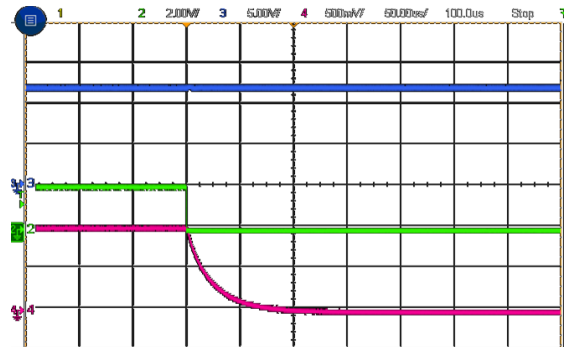

Figure 27. Power-Down Sequence with EN
 CH2: EN CH3: V_{IN} CH4: V_{OUT}

Detailed Description

Overview

The TPP2020 is 2-A synchronous step-down converters. The Constant-On-Time (COT) control topology provides fast transient response and supports low ESR output capacitors, such as specialty polymer capacitors and multi-layer ceramic capacitors, without extra compensation circuitry.

Functional Block Diagram

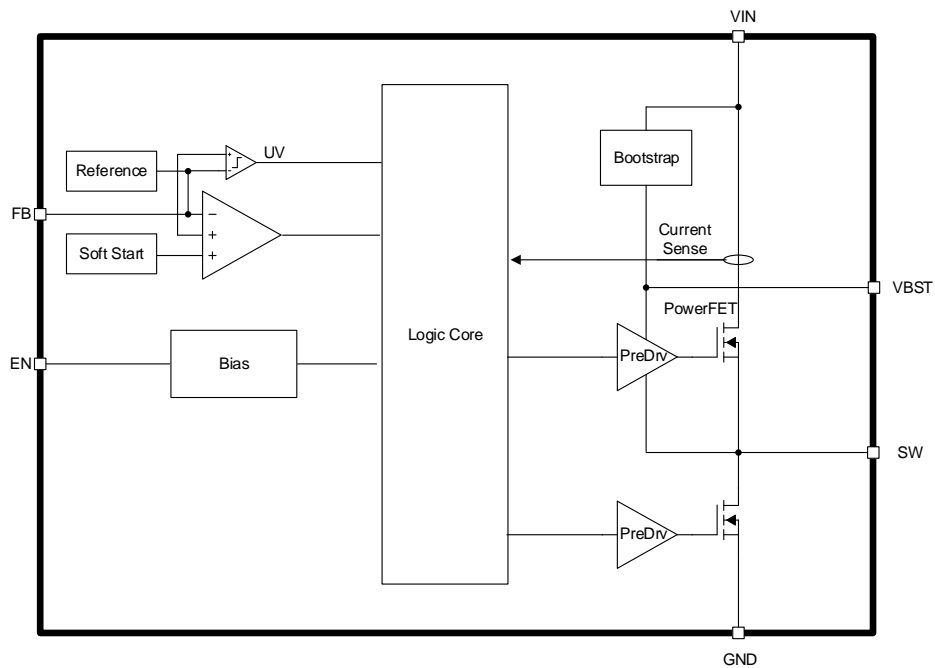

Figure 28 Functional Block Diagram

Feature Description

Constant On-Time Control

TPP2020 uses Constant-On-Time topology, also known as COT topology. The COT topology supports fast transient response thus leading to better ripple performance. With integrated low $R_{ds(on)}$, the device is able to achieve high efficiency in small physical footprint. At the beginning of every cycle, the high-side switch is turned on for a constant on time $T_{(on)}$. The $T_{(on)}$ is internally compensated for different input and output voltage scenarios.

Improved Light-Load Mode

To improve light load efficiency, the device will automatically enter improved light-load mode when inductor ripple valley current reaches zero. The controller keeps the on-time of high-side switch the same. With light-load, the decay of voltage takes longer time and lowers switching frequency accordingly.

Soft-Start with Pre-Biased Capability

17-V Input, 2-A Synchronous Step-Down Voltage Regulator

Once EN becomes high, the device ramps up its internal reference voltage with fixed 1-ms risetime. When the output capacitor is pre-charged, the soft-start ramp will only enable output switching after internal reference ramps above FB voltage.

Over Current Protection

The device has cycle-by-cycle current limit. During OFF state, once over current is detected at ripple current valley by measuring low-side FET current, the device keeps the low-side FET OFF until the current falls below over current protection (OCP) threshold.

Output Undervoltage Hiccup Protection

When the device output voltage falls below hiccup voltage threshold, the device gets into hiccup mode by turning off the device restarts after hiccup timer (typically 10ms) expires.

Undervoltage Lockout (UVLO) Protection

Once the input voltage falls below UVLO threshold, the device is shut off. Once the device recovers above the UVLO threshold, the device returns to normal operation.

Over Temperature Shutdown

Once the junction temperature rises across internal over temperature shutdown threshold, the device shuts off and recovers when temperature falls below threshold with hysteresis.

Application

Application Information

As an easy-to-use step-down voltage regulator, also known as buck regulator, TPP2020 usually converts a higher input voltage to the desired output voltage set by VFB resistor divider. The maximum output current is 2 A. Below section depicts a simplified design flow of circuitry for TPP2020.

Typical Application

In most 12-V system, lower voltage rail such as 5 V / 3.3V is a typical need for microcontrollers, I/Os and other low voltage components. Below application lists the typical schematic for a 5-V buck regulator.

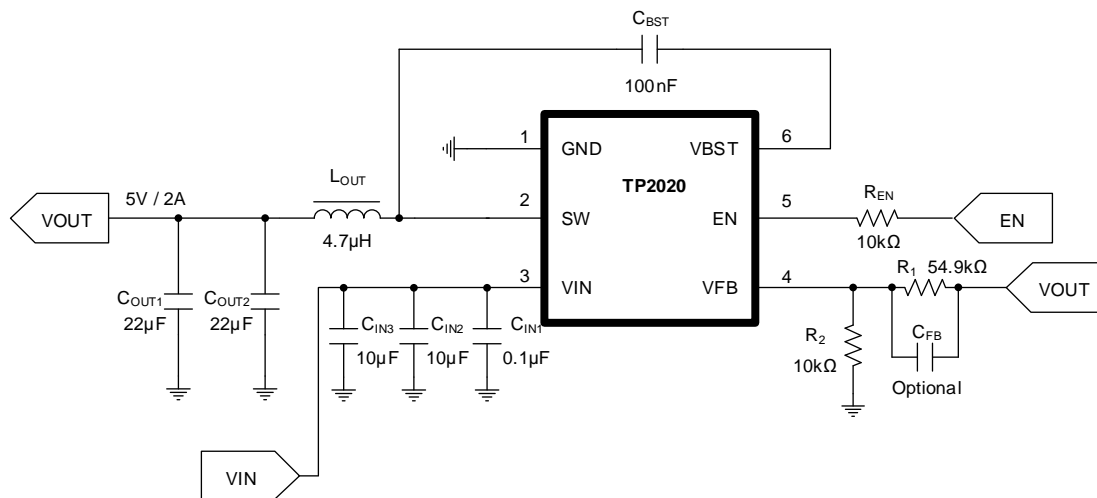

Figure 29 Typical 5V / 2A Application

Component Selection

The 5V output voltage requires the resistor divider ratios to set accordingly.

$$\frac{R_1}{R_2} = \frac{V_{OUT}}{0.76} - 1$$

Set R2 = 10kΩ, by calculation of equation, R1 = 55.8kΩ

Components recommendation table are listed as below.

| Output Voltage (V) | R ₁ (kΩ) | R ₂ (kΩ) | L ₁ (μH) | C _{OUT1} + C _{OUT2} (μF) | C _{IN1} + C _{IN2} + C _{IN3} (μF) | C _{BST} (nF) |
|-----------------------|------------------------|------------------------|------------------------|---|--|--------------------------|
| 1 | 3 | 10 | 2.2 | 20 to 68 | > 0.1 + 10 | 100 |
| 1.2 | 5.76 | 10 | 2.2 | 20 to 68 | > 0.1 + 10 | 100 |
| 1.5 | 9.53 | 10 | 2.2 | 20 to 68 | > 0.1 + 10 | 100 |
| 1.8 | 13.7 | 10 | 3.3 | 20 to 68 | > 0.1 + 10 | 100 |
| 2.5 | 22.6 | 10 | 3.3 | 20 to 68 | > 0.1 + 10 | 100 |
| 3.3 | 33.2 | 10 | 3.3 | 20 to 68 | > 0.1 + 10 | 100 |
| 5 | 55.8 | 10 | 4.7 | 20 to 68 | > 0.1 + 10 | 100 |

The inductor peak current I_{PEAK} , peak-to-peak ripple ΔI_{P-P} current and RMS current $I_{LOUT(RMS)}$ are calculated as below equations.

$$\Delta I_{P-P} = \frac{V_{OUT}}{V_{IN(MAX)}} \times \frac{V_{IN(MAX)} - V_{OUT}}{L_{OUT} \times f_{SW}}$$

$$I_{PEAK} = I_O + \frac{1}{2} \times \frac{V_{OUT}}{V_{IN(MAX)}} \times \frac{V_{IN(MAX)} - V_{OUT}}{L_{OUT} \times f_{SW}}$$

$$I_{LOUT(RMS)} = \sqrt{I_O^2 + \frac{1}{12} \times \left(\frac{V_{OUT}}{V_{IN(MAX)}} \times \frac{V_{IN(MAX)} - V_{OUT}}{L_{OUT} \times f_{SW}} \right)^2}$$

The output capacitor rms current is calculated as below equation

$$I_{COUT(RMS)} = \frac{V_{OUT} \times (V_{IN} - V_{OUT})}{\sqrt{12} \times V_{IN} \times L_{OUT} \times f_{SW}}$$

Input capacitor RMS current is calculated as below equation

$$I_{CIN(RMS)} = I_O \times \sqrt{\frac{V_{IN}}{V_{OUT}} \times \left(1 - \frac{V_{IN}}{V_{OUT}} \right)}$$

Layout Recommendations

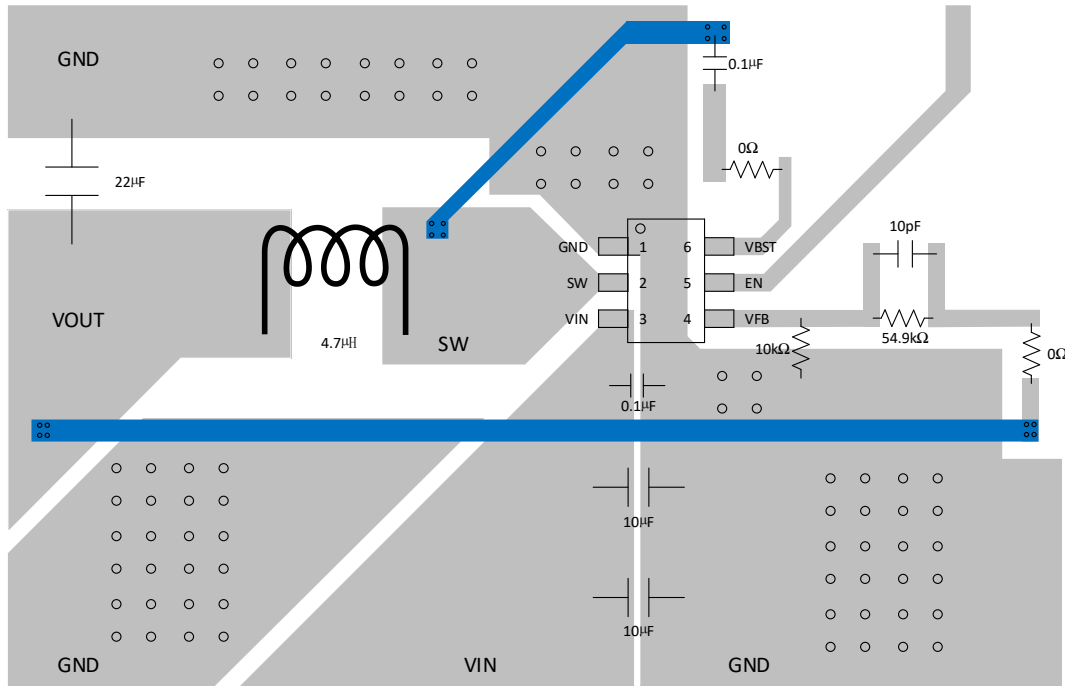

Tape and Reel Information

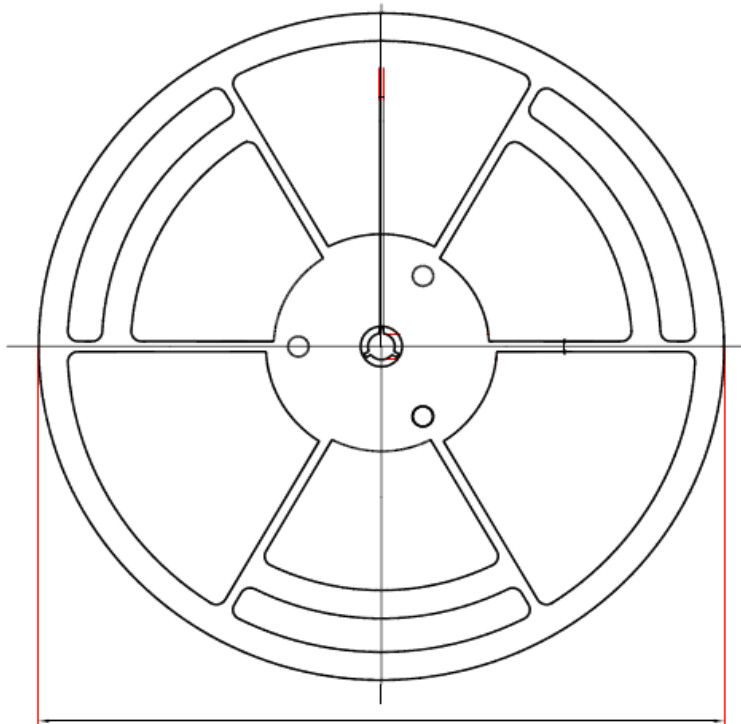

D1: Reel Diameter

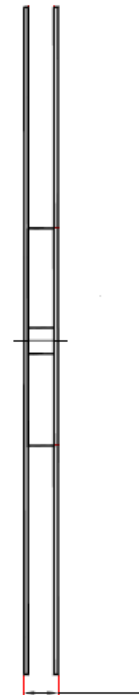

W1: Reel Width

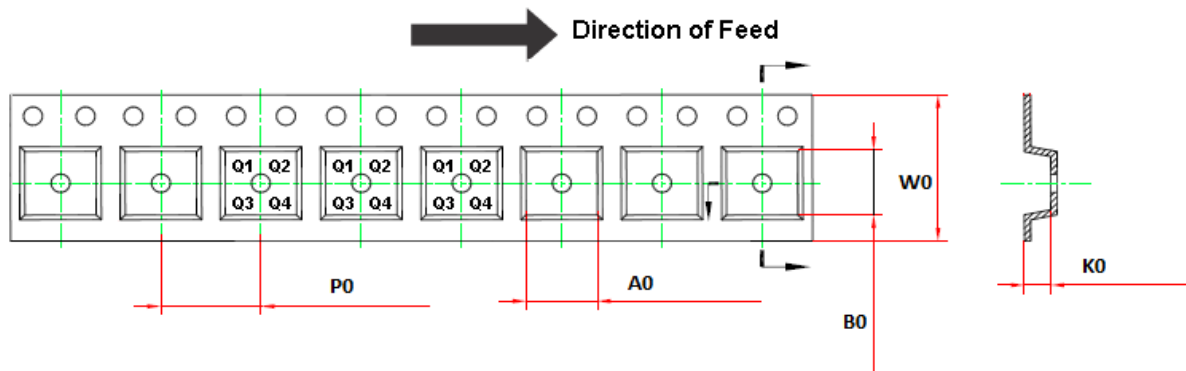

| Order Number | Package | D1 | W1 | A0 | B0 | K0 | P0 | W0 | Pin1 Quadrant |
|--------------|----------|-------|------|-----|-----|-----|-----|-----|---------------|
| TPP2020-6TR | TSOT23-6 | 178.0 | 12.3 | 3.2 | 3.2 | 1.4 | 4.0 | 8.0 | Q3 |

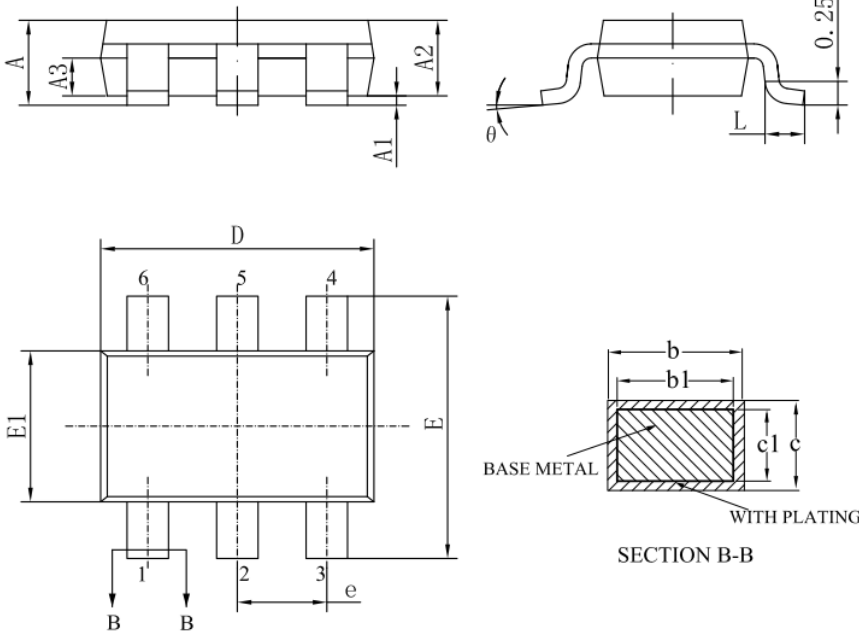
Package Outline Dimensions
TSOT23-6

| SYMBOL | MILLIMETER | | |
|----------|------------|------|------|
| | MIN | NOM | MAX |
| A | — | — | 0.95 |
| A1 | 0 | — | 0.10 |
| A2 | 0.75 | 0.80 | 0.85 |
| A3 | 0.35 | 0.40 | 0.45 |
| b | 0.30 | 0.44 | 0.50 |
| b1 | 0.30 | 0.40 | 0.45 |
| c | 0.11 | 0.16 | 0.20 |
| c1 | 0.11 | 0.13 | 0.15 |
| D | 2.70 | 2.90 | 3.10 |
| E | 2.60 | 2.80 | 3.00 |
| E1 | 1.50 | 1.60 | 1.70 |
| e | 0.95BSC | | |
| L | 0.30 | 0.40 | 0.50 |
| θ | 0 | — | 8° |

3PEAK and the 3PEAK logo are registered trademarks of 3PEAK INCORPORATED. All other trademarks are the property of their respective owners.