



AM30CW-NZ



The AM30CW-NZ is a 30W DC/DC converter that offers a regulated output which contributes to a more stable and reliable output performance. It features a wide 4:1 input voltage range of 18-75VDC, which will benefit your new system design.

This series offers great operating temperatures, from -40°C to 85°C. Furthermore, an isolation of 1500VDC, a high MTBF of 1,000,000h, continuous output short circuit protection (OSCP), over-current protection (OCP), over-voltage protection (OVP), and under voltage lock-out (UVLO) come standard with the series.

The AM30CW-NZ is suitable for grid power, instrumentation, industrial controls, communication, and civil applications.

Features



- Operating Temp: -40 °C to +85 °C
- Isolation voltage: 1500VDC
- High efficiency: Up to 88% typ.
- Regulated single output
- Output short circuit, over-current, over-voltage, input under voltage protection
- Standard 1 x1 package
- Design to meet EN62368

Summary

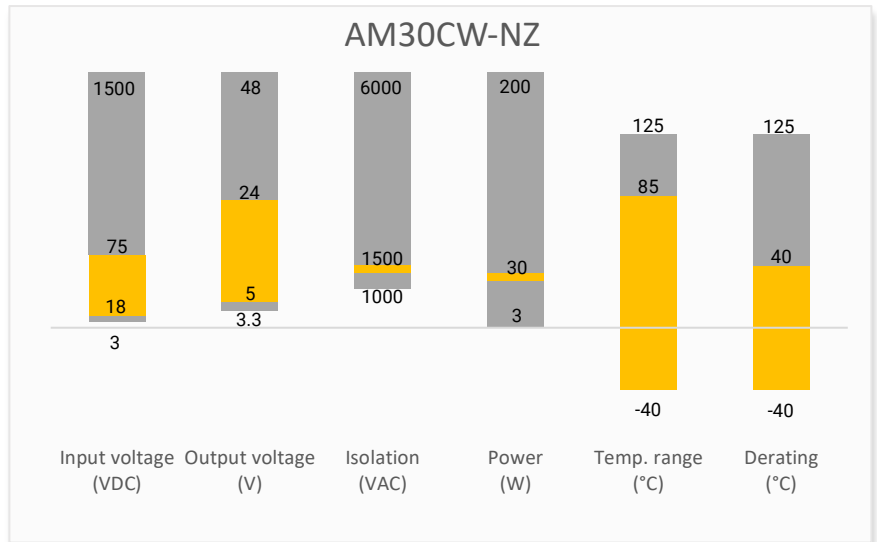

Training



Applications

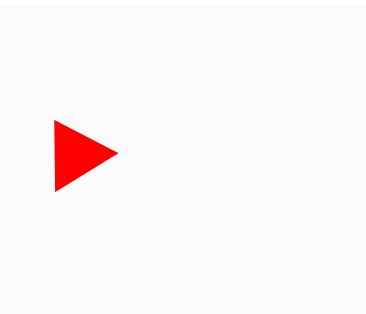

Product Training Video
(click to open)

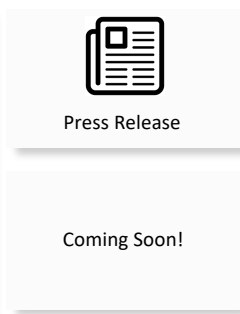

Application Notes



Power Grid



Industrial



Telecom



Instrumentation

Models & Specifications

Single Output							
Model	Input Voltage (VDC)	Output Voltage (VDC)	Nominal Vin Input Current Max (mA)		Output Current Max (A)	Maximum Capacitive Load (μ F)	Efficiency Full Load Typ (%)
			No Load	Full Load			
AM30CW-4805SNZ	48 (18-75)	5	15	735	6	7200	88
AM30CW-4812SNZ	48 (18-75)	12	15	735	2.5	2000	88
AM30CW-4815SNZ	48 (18-75)	15	15	735	2	1500	88
AM30CW-4824SNZ	48 (18-75)	24	15	735	1.25	470	88

Input Specification				
Parameters	Conditions	Typical	Maximum	Units
Input voltage	Nominal input	18-75	80	VDC
Absolute maximum rating	Nominal input, 1s max.	\geq 0.7	100	VDC
Start-up voltage			18	VDC
Start-up time	Nominal input	10		ms
Input reflected current	Nominal input	40		mA
Input under-voltage protection		15.5		VDC
On/Off control	On	Control pin open or 3.5-12VDC		
	Off	Control pin short to $-V_{in}$ or 0-1.2VDC		
	Idle current	2	7	mA
Input filter	Capacitor filter			

Isolation Specification				
Parameters	Conditions	Typical	Maximum	Units
Tested isolation voltage	Input / output, 60 sec, \leq 1mA	\geq 1500		VDC
Resistance	Input / output, 500VDC	\geq 1000		M Ω
Capacitance	Input / output, 100KHz / 0.1V	2000		pF

Output Specification				
Parameters	Conditions	Typical	Maximum	Units
Voltage accuracy	5% -100% load	\pm 1	\pm 3	%
Line regulation	LL – HL 100% load	\pm 0.2	\pm 0.5	%
Load regulation	5% -100% load	\pm 0.5	\pm 1	%
Transient Recovery Time	25% load step change	250	500	μ s
Transient Response Deviation	25% load step change, 5V output	\pm 3	\pm 8	%
	25% load step change, others	\pm 3	\pm 5	%
Ripple & Noise	5% -100% load, 24V output	60	150	mV pk-pk
	5% -100% load, others	60	120	mV pk-pk
Voltage adjustment			\pm 10	%

* Ripple and Noise are measured at 20MHz bandwidth. Please refer to the application note for specific details.

General Specifications

Parameters	Conditions	Typical	Maximum	Units
Switching frequency*	100% load	270		KHz
Short circuit protection	Continues, Auto recovery			
Over Current protection		170	260	% of Iout
Over voltage protection		≥110	160	% of Vout
Operating temperature	With derating	-40 to +85		°C
Storage temperature		-55 to +125		°C
Soldering temperature	1.5mm distance, ≤ 10s		300	°C
Temperature coefficient	100% Load		± 0.03	%/°C
Cooling	Free air convection			
Humidity	Non-condensing	≥5	95	% RH
Weight		18.4		g
Vibration test	10-150Hz, 5G, 0.75mm, 90min along all axis			
Dimensions (L x W x H)	1.00x 1.00 x 0.46 inches (25.40 x 25.40 x 11.70 mm)			
Case material	Aluminum			
MTBF	≥ 1 000 000 hrs (MIL-HDBK -217F, t=+25°C)			

*Switching frequency reduced when load < 50%.

NOTE: All specifications in this datasheet are measured at an ambient temperature of 25°C, humidity<75%, nominal input voltage and at rated output load unless otherwise specified.

Safety Specifications

Parameters

Standards	Design to meet EN62368	
	EMI - Conducted and radiated emission	CISPR32/EN55032 Class B with the recommended EMC circuit part B CISPR32/EN55032 Class A with the recommended EMI circuit
	Electrostatic Discharge Immunity	IEC/EN 61000-4-2, Contact ±6KV, Criteria B
	RF, Electromagnetic Field Immunity	IEC/EN 61000-4-3, 10V/m, Criteria B
	Electrical Fast Transient/Burst Immunity	IEC/EN 61000-4-4, ±2KV, Criteria B with the recommended EMC circuit part A
	Surge Immunity	IEC/EN 61000-4-5, L-L ±2KV, Criteria B with the recommended EMC circuit part A
	RF, Conducted Disturbance Immunity	IEC/EN 61000-4-6, 3Vr.m.s, Criteria B

Derating

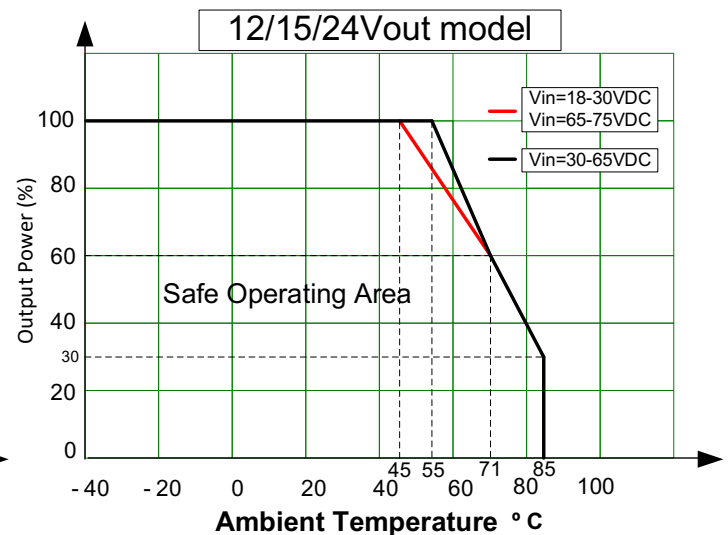
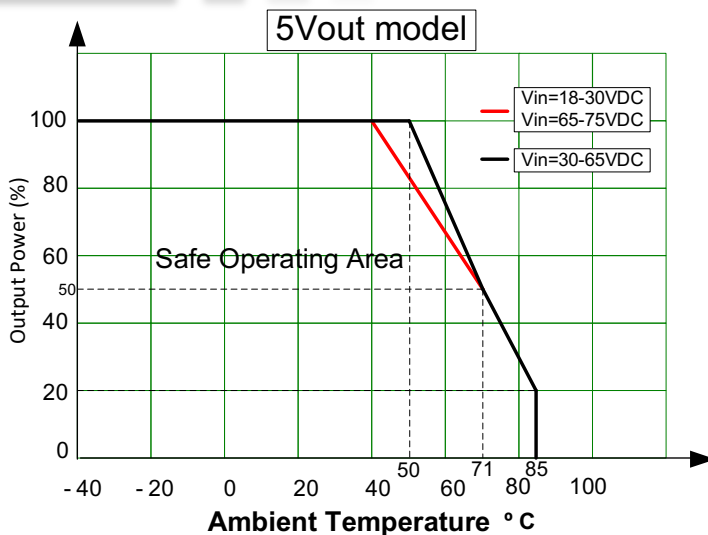

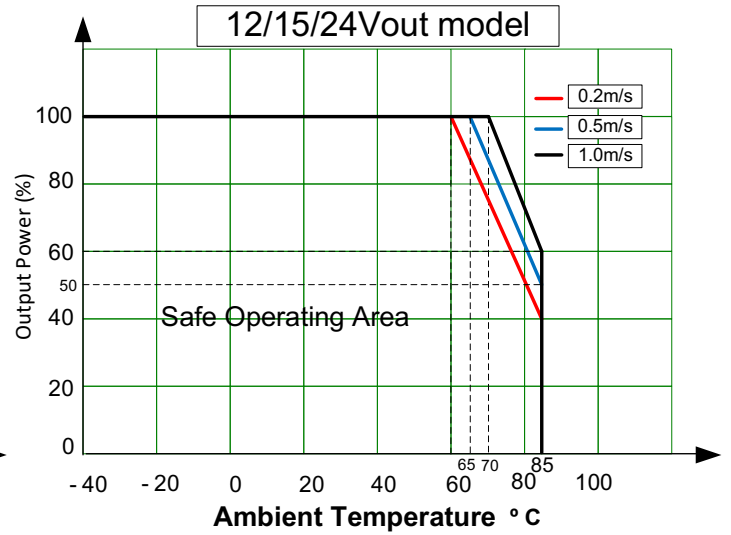
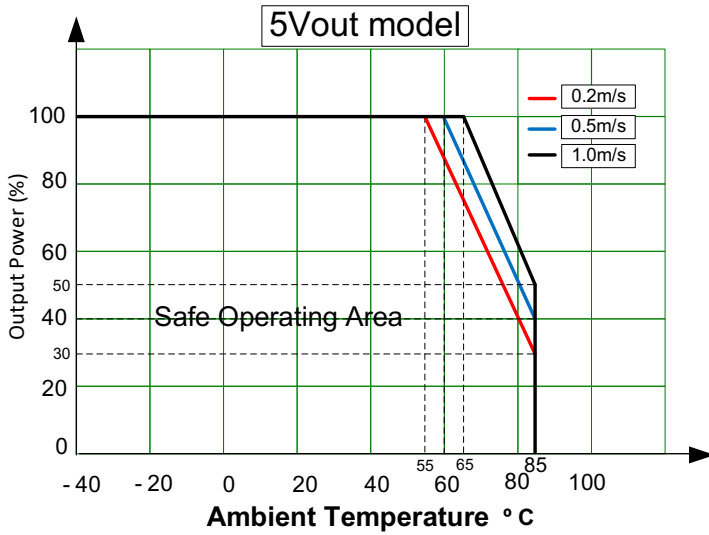

Typical application circuit

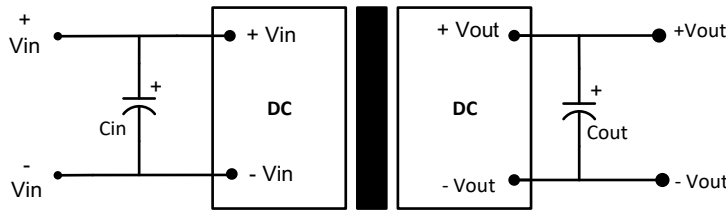

Single output		
Vout	Cin	Cout
5/12/15	100μF	100μF
24	100μF	47μF

Recommended EMC circuit

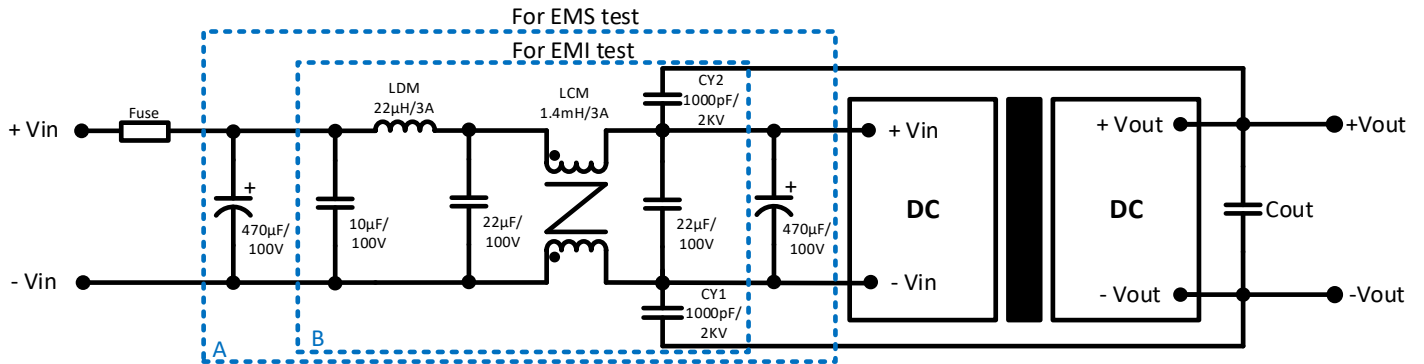

Notes: Part A for EMS filtering and Part B is used for EMI filtering.

Recommended EMI circuit

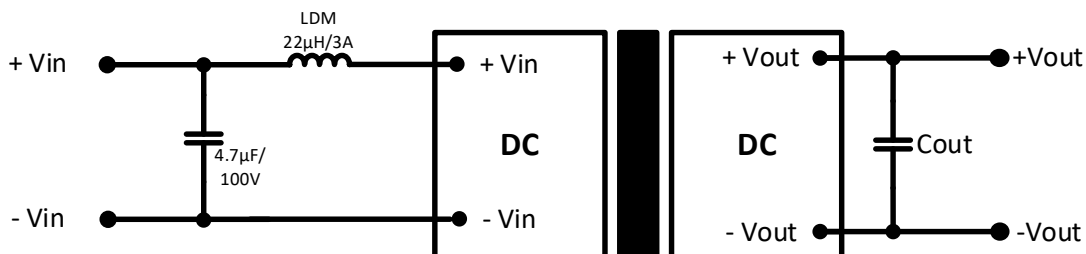

Dimension

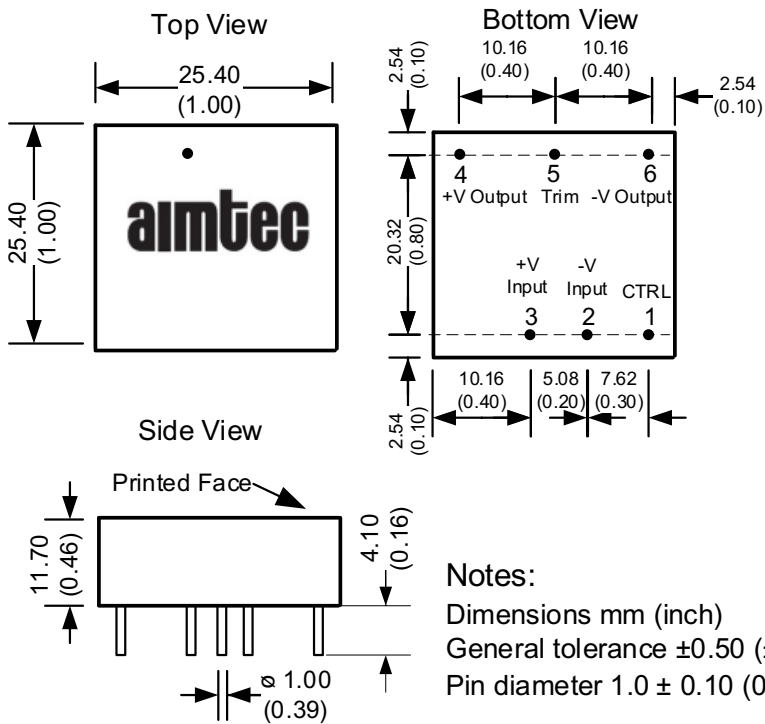

Pin Out Specifications	
Pin	Single
1	On/off control
2	-Vin
3	+Vin
4	+Vout
5	Trim
6	-Vout

Trim

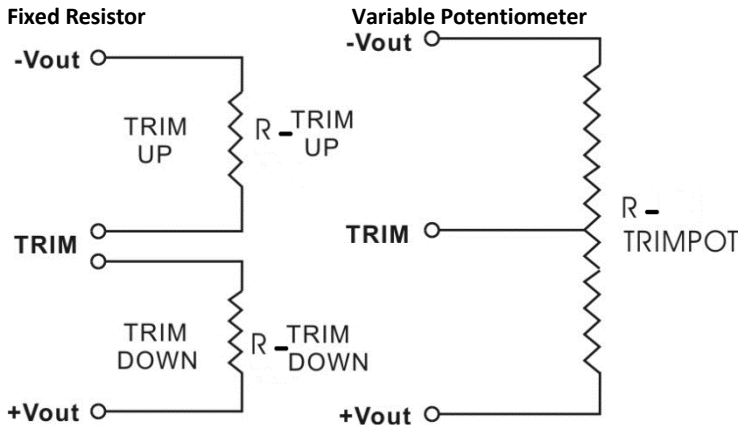

Vout = 5V

Trim down %	1	2	3	4	5	6	7	8	9	10
Vout (VDC)	4.95	4.9	4.85	4.8	4.75	4.7	4.65	4.6	4.55	4.5
Rt down (K Ω)	299.364	197.323	144.837	112.86	91.336	75.859	64.195	55.09	47.784	41.793
Trim up %	1	2	3	4	5	6	7	8	9	10
Vout (VDC)	5.05	5.1	5.15	5.2	5.25	5.3	5.35	5.4	5.45	5.5
Rt up (K Ω)	-1861.079	238.43	106.404	66.009	46.428	34.869	27.24	21.829	17.79	14.661

Vout = 12V

Trim down %	1	2	3	4	5	6	7	8	9	10
Vout (VDC)	11.88	11.76	11.64	11.52	11.4	11.28	11.16	11.04	10.92	10.8
Rt down (KΩ)	502.892	308.252	219.327	168.385	135.373	112.242	95.132	81.964	71.516	63.023
Trim up %	1	2	3	4	5	6	7	8	9	10
Vout (VDC)	12.12	12.24	12.36	12.48	12.6	12.72	12.84	12.96	13.08	13.2
Rt up (KΩ)	713.235	165.72	90.679	60.875	44.877	34.895	28.074	23.117	19.352	16.395

Vout = 15V

Trim down %	1	2	3	4	5	6	7	8	9	10
Vout (VDC)	14.85	14.7	14.55	14.4	14.25	14.1	13.95	13.8	13.65	13.5
Rt down (KΩ)	908.813	501.361	341.572	256.271	203.218	167.033	140.774	120.851	105.216	92.62
Trim up %	1	2	3	4	5	6	7	8	9	10
Vout (VDC)	15.15	15.3	15.45	15.6	15.75	15.9	16.05	16.2	16.35	16.5
Rt up (KΩ)	328.2	130.38	78.573	54.696	40.959	32.034	25.769	21.13	17.556	14.718

Vout = 24V

Trim down %	1	2	3	4	5	6	7	8	9	10
Vout (VDC)	23.76	23.52	23.28	23.04	22.8	22.56	22.32	22.08	21.84	21.6
Rt down (KΩ)	1302.021	804.549	577.271	447.071	362.697	303.576	259.846	226.19	199.486	177.781
Trim up %	1	2	3	4	5	6	7	8	9	10
Vout (VDC)	24.24	24.48	24.72	24.96	25.2	25.44	25.68	25.92	26.16	26.4
Rt up (KΩ)	808.05	189.109	104.278	70.586	52.501	41.217	33.506	27.902	23.646	20.303

NOTE: **1.** Datasheets are updated as needed and as such, specifications are subject to change without notice. Once printed or downloaded, datasheets are no longer controlled by Aimtec; refer to www.aimtec.com for the most current product specifications. **2.** Product labels shown, including safety agency certifications on labels, may vary based on the date manufactured. **3.** Mechanical drawings and specifications are for reference only. **4.** All specifications are measured at an ambient temperature of 25°C, humidity<75%, nominal input voltage and at rated output load unless otherwise specified. **5.** Aimtec may not have conducted destructive testing or chemical analysis on all internal components and chemicals at the time of publishing this document. CAS numbers and other limited information are considered proprietary and may not be available for release. **6.** This product is not designed for use in critical life support systems, equipment used in hazardous environments, nuclear control systems or other such applications which necessitate specific safety and regulatory standards other the ones listed in this datasheet. **7.** Warranty is in accordance with Aimtec's standard Terms of Sale available at www.aimtec.com.