

Typical Features

- ◆ Fixed input voltage, Isolated & unregulated output, Output power 1W
- ◆ High Efficiency up to 80%
- ◆ Small compact SIP packing
- ◆ No external component required
- ◆ Isolation Voltage 1500VDC
- ◆ Operating Temperature: -40℃~+85℃
- ◆ Plastic Case, meet UL94-V0 standard



Test Condition: Unless otherwise specified, data in the datasheet should be tested under the conditions of inputting nominal voltage, pure resistance rated load and Ta=25℃

Application Field

It could be widely used for instrument, communication, pure digital circuit, general low frequency analog circuit, relay drive circuit, data exchange circuit, etc.

Typical Product List

Model	Input Voltage Range (VDC)		Output Voltage/Current (Vo/Io)		Input Current(mA) Nominal Voltage		Max. Capacitive Load uF	Ripple & Noise (Max.) mVp-p	Efficiency (%)	
	Nominal	Range	Voltage (VDC)	Current(mA) MAX./Min.	Full load Typ.	No Load Typ.			Min.	Typ.
FN1-3V3S3V3A	3.3	3.0 - 3.6	3.3	300	433	50	220	100	70	72
FN1-3V3S05A			5	200	421	50	220	100	72	74
FN1-3V3S09A			9	110	410	50	100	100	72	74
FN1-3V3S12A			12	83	410	50	100	100	72	74
FN1-3V3S15A			15	67	410	50	100	100	72	74
FN1-3V3S24A			24	42	421	50	47	120	70	72
FN1-05S3V3A	5	4.5 - 5.5	3.3	300	278	40	220	100	74	76
FN1-05S05A			5	200	263	40	220	100	77	79
FN1-05S09A			9	110	263	40	100	100	78	80
FN1-05S12A			12	83	260	40	100	100	76	78
FN1-05S15A			15	67	260	40	100	100	76	78
FN1-05S24A			24	42	256	40	47	120	76	78
FN1-09S3V3A	9	8.1 - 9.9	3.3	300	154	25	220	100	74	76
FN1-09S05A			5	200	146	25	220	100	77	79
FN1-09S09A			9	110	146	25	100	100	78	80
FN1-09S12A			12	83	144	25	100	100	78	80

FN1-09S15A			15	67	144	25	100	100	78	80
FN1-09S24A			24	42	139	25	47	120	78	80
FN1-12S3V3A	12	10.8 - 13.2	3.3	300	116	18	220	100	74	76
FN1-12S05A			5	200	108	18	220	100	77	79
FN1-12S09A			9	110	108	18	100	100	78	80
FN1-12S12A			12	83	108	18	100	100	78	80
FN1-12S15A			15	67	107	18	100	100	78	80
FN1-12S24A			24	42	104	18	47	120	78	80
FN1-15S3V3A			15	13.5 - 16.5	3.3	300	93	15	220	100
FN1-15S05A	5	200			89	15	220	100	77	79
FN1-15S09A	9	110			89	15	100	100	77	79
FN1-15S12A	12	83			88	15	100	100	78	80
FN1-15S15A	15	67			88	15	100	100	78	80
FN1-15S24A	24	42			84	15	47	120	77	79
FN1-24S3V3A	24	21.6 - 26.4	3.3	300	59	10	220	100	69	75
FN1-24S05A			5	200	55	10	220	100	75	77
FN1-24S09A			9	110	54	10	100	100	76	78
FN1-24S12A			12	83	54	10	100	100	75	77
FN1-24S15A			15	67	53	10	100	100	76	78
FN1-24S24A			24	42	53	10	47	120	76	78

1. “*” are models being developing;

2. To ensure this module operate efficiently and reliably, the minimum output load could not be less than 10% of the nominal load during operation. If the actual output power is too small, please connect a resistor in parallel at the output, the resistance recommended equal to 10% nominal power;

Input Specifications

Item	Test Condition	Min.	Typ.	Max.	Unit
Input Overshoot Voltage (1Second.max.)	3.3Vdc Input	-0.7	-	7	VDC
	5Vdc Input	-0.7	-	9	
	9Vdc Input	-0.7	-	12	
	12Vdc Input	-0.7	-	18	
	15Vdc Input	-0.7	-	21	
	24Vdc Input	-0.7	-	30	
Input Filter	Capacitor Filter				

Output Specifications

ITEM	Working Conditions		Min.	Typ.	Max.	Unit
Output Power			0.1	--	1	W
Output Voltage Accuracy	Nominal input, Full load		--	±2	±5	%
Load Regulation	10% ~ 100% nominal load	3.3Vdc output	--	--	20	
		Other output	--	--	15	
Line Voltage Regulation	Input Voltage Change±1%	3.3Vdc output	--	--	±1.5	
		Other output	--	--	±1.2	
Ripple & Noise①	Nominal input,full load,20MHZ bandwidth		--	75	100	mVp-p
Temperature Drift Coefficient	100% Full Load		--	--	±0.03	%/°C
Output Short Circuit Protection						

NOTE:① Ripple & Noise Tested by twisted-pair method, for details please check Design and Application Circuit.

②Small part could be guaranteed to be within 5s;

General Specifications

Switching Frequency	typical	100KHz (Typ.)
Operating Temperature	Refer to Temperature Derating Curve	-40°C ~ +85°C
Storage Temperature		-55°C ~ +125°C
Shell temperature rising when operating	Within Temperature Derating Curve	25°C
Relative Humidity	No condensing	5%~95%
Case Material		Black flame-retardant heat-resistant Plastic(UL94-V0)
Product Weight		2.4g(Typ.)
Isolation Voltage	Test 1 minute, leakage current < 0.5mA	1500Vdc ≤ 0.5mA / 1min
Isolation Capacitor	Input/Output,100KHz/0.1V	20 pF (Typ.)
MTBF	MIL-HDBK-217F@25°C	35X10 ⁵ Hrs

/



Packing Dimension

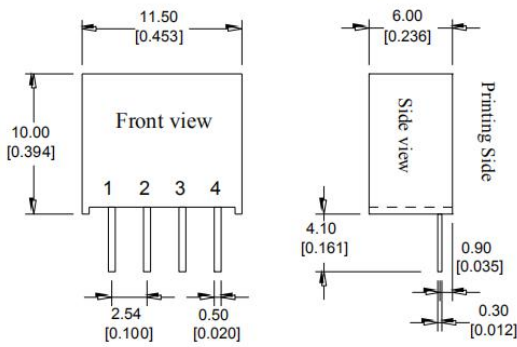

Packing Dimension

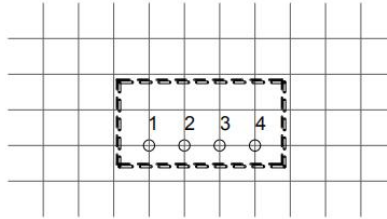

Printed board vertical view

Lattice spacing: 2.54mm (0.1inch)

Recommended PCB layout

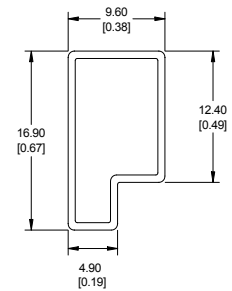

Unit: mm[inch]

General tolerance:

x.x±0.5mm[x.x±0.020inch]

0.x±0.2mm[x.x±0.008inch]

Packing

Packing Code	L x W x H	
A	11.50× 6.00 × 10.00mm	0.453 × 0.236 × 0.394inch

Pin Function

Single(S)	1	2	3	4
	GND	+Vin	-Vo	+Vo

Note: if the definition of pin is not in accordance with the model selection manual, please refer to the label on actual item.

Ripple & Noise Test: (Twisted Pair Method 20MHZ bandwidth)

Test Method:

a. 12# twisted pair to connect, Oscilloscope bandwidth set as 20MHz, 100M bandwidth probe, terminated with 0.1uF polypropylene capacitor and 10uF high frequency low resistance electrolytic capacitor in parallel, oscilloscope set as Sample pattern.

b. Input terminal connect to power supply, output terminal connect to electronic load through jig plate, Use 30cm±2 cm sampling line, Power line selected from corresponding diameter wire with insulation according to the flow of output current.

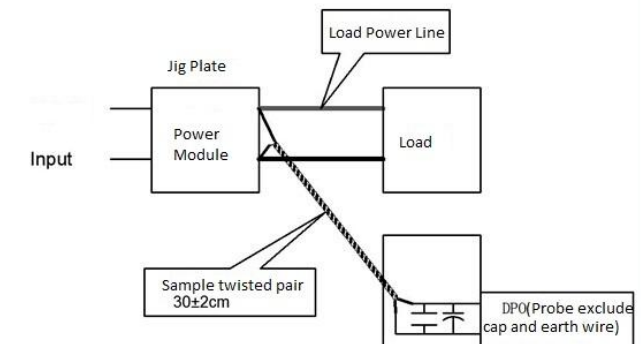

/



Temperature Curve

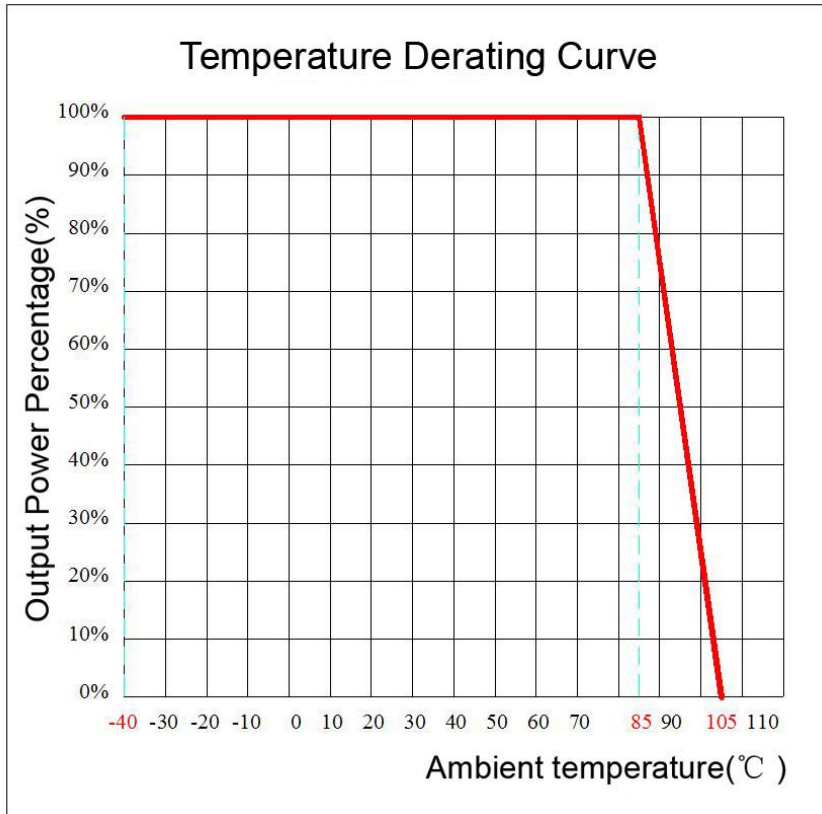

/

Design and Application Circuit Recommended

1. Output load requirements

- a. In order to ensure the converter can work reliably with high efficiency, the minimum load should not less than 10% rated load when it is used. If the needed power is indeed small, please parallel a resistor at the output side, the resistance equal to 10% nominal load.
- b. The maximum capacitive load is tested under nominal input full load, and cannot exceed the maximum capacitive load of output terminal under operation, otherwise it will cause it difficult to start up and damage the product.

2. Recommended circuit

In order to ensure the input/output ripple and noise decreased, capacitor filter net could be connected to input and output terminal, application circuit as below photo 1; choosing suitable filter capacitor is very important, start-up problems may be caused by too large capacitance. To ensure the modules running safely and reliably, the recommended capacitive load values as shown in Table 1. (But for the actual output power of application circuit is less than 0.5W, suggest not to connect external capacitor)

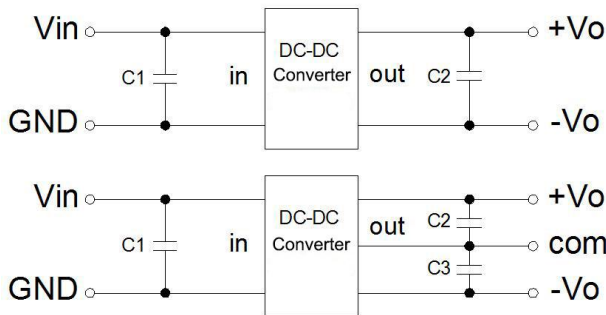

Recommended capacitive load value(Table 1)

Vin (Vdc)	C1 (μF)	Vout (Vdc)	C2 (μF)	Vout (Vdc)	C2,C3 (μF)
3.3/5	4.7	3.3/5	10	±3.3/±5	4.7
12	2.2	9	4.7	±9	2.2
15	1	12	2.2	±12	1
24	1	15	1	±15	0.47
--	--	24	0.47	±24	0.22

3. Output regulated voltage and over voltage protection circuit

The simplest device to protect output regulated voltage, over voltage and over current is to cascade a linear regulator with overheat protection at input or output terminal, and connect a capacitor filter net(see below picture), filter capacitive value recommended see table 1, Linear regulator is chosen according to the actual voltage, current needed in working, or choose our NW series products.

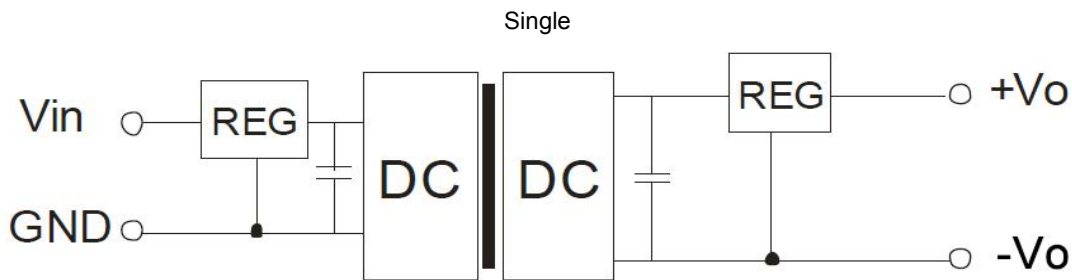

Note:

- 1.This product cannot be used in parallel, and do not support hot-plugging;
- 2.If the product works below the minimum required load, it cannot guarantee that the product performance meets all performance indicators in this manual;
3. All index testing methods in this datasheet are based on our Company's corporate standards
4. The product specification may be changed at any time without prior notice.