

### FEATURES

Qualified for automotive applications

$\pm 4000$  V HBM ESD

High common-mode voltage range

-2 V to +65 V operating

-3 V to +68 V survival

Buffered output voltage

Wide operating temperature range

5-lead SOT:  $-40^{\circ}\text{C}$  to  $+125^{\circ}\text{C}$

Excellent ac and dc performance

$5 \mu\text{V}/^{\circ}\text{C}$  typical offset drift

$-13 \text{ ppm}/^{\circ}\text{C}$  typical gain drift

120 dB typical CMRR at dc

### APPLICATIONS

High-side current sensing

Motor controls

Transmission controls

Engine management

Suspension controls

Vehicle dynamic controls

DC-to-dc converters

### GENERAL DESCRIPTION

The AD8211 is a high voltage, precision current shunt amplifier. It features a set gain of 20 V/V, with a typical  $\pm 0.35\%$  gain error over the entire temperature range. The buffered output voltage directly interfaces with any typical converter. Excellent common-mode rejection from -2 V to +65 V is independent of the 5 V supply. The AD8211 performs unidirectional current measurements across a shunt resistor in a variety of industrial and automotive applications, such as motor control, solenoid control, or battery management.

### FUNCTIONAL BLOCK DIAGRAM

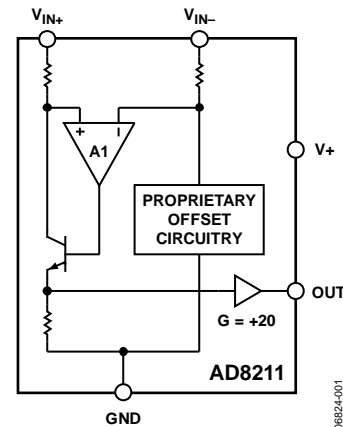

Figure 1.

06824-001

Special circuitry is devoted to output linearity being maintained throughout the input differential voltage range of 0 mV to 250 mV, regardless of the common-mode voltage present. The AD8211 has an operating temperature range of  $-40^{\circ}\text{C}$  to  $+125^{\circ}\text{C}$  and is offered in a small 5-lead SOT package.

#### Rev. A

Information furnished by Analog Devices is believed to be accurate and reliable. However, no responsibility is assumed by Analog Devices for its use, nor for any infringements of patents or other rights of third parties that may result from its use. Specifications subject to change without notice. No license is granted by implication or otherwise under any patent or patent rights of Analog Devices. Trademarks and registered trademarks are the property of their respective owners.

## TABLE OF CONTENTS

Features .....	1	Theory of Operation .....	10
Applications .....	1	Application Notes .....	11
Functional Block Diagram .....	1	Output Linearity .....	11
General Description .....	1	Applications Information .....	12
Revision History .....	2	High-Side Current Sense with a Low-Side Switch .....	12
Specifications .....	3	High-Side Current Sensing .....	12
Absolute Maximum Ratings .....	4	Low-Side Current Sensing .....	12
ESD Caution .....	4	Outline Dimensions .....	13
Pin Configuration and Function Descriptions .....	5	Ordering Guide .....	13
Typical Performance Characteristics .....	6		

## REVISION HISTORY

### 3/11—Rev. 0 to Rev. A

Added Automotive Products Information .....	Throughout
Changes to General Description, Gain Error Percentage .....	1
Changes to Table 1 .....	3
Changes to Table 2 .....	4
Updated Outline Dimensions .....	13
Changes to Ordering Guide .....	13

### 7/07—Revision 0: Initial Version

## SPECIFICATIONS

$T_{OPR} = -40^{\circ}\text{C}$  to  $+125^{\circ}\text{C}$ ,  $T_A = 25^{\circ}\text{C}$ ,  $V_S = 5\text{ V}$ ,  $R_L = 25\text{ k}\Omega$  ( $R_L$  is the output load resistor), unless otherwise noted.

**Table 1.**

Parameter	Y GRADE			W GRADE			Unit	Conditions
	Min	Typ	Max	Min	Typ	Max		
<b>GAIN</b>								
Initial		20			20		V/V	$V_O \geq 0.1\text{ V dc}$ $T_{OPR}$ $T_{OPR}^1$
Accuracy			$\pm 0.25$			$\pm 0.25$	%	
Accuracy Over Temperature		$\pm 0.35$				$\pm 0.4$	%	
Gain vs. Temperature		-13			-13		ppm/ $^{\circ}\text{C}$	
<b>VOLTAGE OFFSET</b>								
Offset Voltage (RTI)			$\pm 1$			$\pm 1$	mV	$25^{\circ}\text{C}$
Over Temperature (RTI)		$\pm 2.2$				$\pm 2.5$	mV	$T_{OPR}$
Offset Drift		5			5		$\mu\text{V}/^{\circ}\text{C}$	$T_{OPR}^2$
<b>INPUT</b>								
Input Impedance								Common-mode voltage > 5 V Common-mode voltage < 5 V Common-mode continuous
Differential		5			5		k $\Omega$	
Common Mode		5			5		M $\Omega$	
		3.5			3.5		k $\Omega$	
Common-Mode Input Voltage Range	-2		+65	-2		+65	V	
Differential Input Voltage Range		250			250		mV	Differential input voltage
Common-Mode Rejection	100	120		100	120		dB	$T_{OPR}$ , $f = \text{dc}$ , $V_{CM} > 5\text{ V}$ , see Figure 5
	80	90		80	90		dB	$T_{OPR}$ , $f = \text{dc}$ , $V_{CM} < 5\text{ V}$ , see Figure 5
<b>OUTPUT</b>								
Output Voltage Range Low	0.1	0.05		0.1	0.05		V	$T_{OPR}$
Output Voltage Range High		4.95	4.9		4.95	4.9	V	$T_{OPR}$
Output Impedance		2			2		$\Omega$	
<b>DYNAMIC RESPONSE</b>								
Small Signal -3 dB Bandwidth		500			500		kHz	
Slew Rate		4.5			4.5		V/ $\mu\text{s}$	
<b>NOISE</b>								
0.1 Hz to 10 Hz, RTI		7			7		$\mu\text{V p-p}$	
Spectral Density, 1 kHz, RTI		70			70		nV/ $\sqrt{\text{Hz}}$	
<b>POWER SUPPLY</b>								
Operating Range	4.5		5.5	4.5		5.5	V	$V_{CM} > 5\text{ V}^3$ , see Figure 12
Quiescent Current Over Temperature		1.2	2.0		1.2	2.0	mA	
Power Supply Rejection Ratio	76			76			dB	
<b>TEMPERATURE RANGE</b>								
For Specified Performance	-40		+125	-40		+125	$^{\circ}\text{C}$	

<sup>1</sup> The mean of the gain drift distribution is typically  $-13\text{ ppm}/^{\circ}\text{C}$ , with a  $\sigma = 3\text{ ppm}/^{\circ}\text{C}$ .

<sup>2</sup> The mean of the offset drift distribution is typically  $+5\text{ }\mu\text{V}/^{\circ}\text{C}$ , with a  $\sigma = 3\text{ }\mu\text{V}/^{\circ}\text{C}$ .

<sup>3</sup> When the input common-mode voltage is less than 5 V, the supply current increases, which can be calculated by  $I_S = -0.275(V_{CM}) + 2.5$ .

## ABSOLUTE MAXIMUM RATINGS

Table 2.

Parameter	Rating
Supply Voltage	12.5 V
Continuous Input Voltage	-3 V to +68 V
Reverse Supply Voltage	-0.3 V
Differential Input Voltage	±500 mV
HBM (Human Body Model) ESD Rating	±4000 V
CDM (Charged Device Model) ESD Rating	±1000 V
Operating Temperature Range	-40°C to +125°C
Storage Temperature Range	-65°C to +150°C
Output Short-Circuit Duration	Indefinite

Stresses above those listed under Absolute Maximum Ratings may cause permanent damage to the device. This is a stress rating only; functional operation of the device at these or any other conditions above those indicated in the operational section of this specification is not implied. Exposure to absolute maximum rating conditions for extended periods may affect device reliability.

### ESD CAUTION



**ESD (electrostatic discharge) sensitive device.** Charged devices and circuit boards can discharge without detection. Although this product features patented or proprietary protection circuitry, damage may occur on devices subjected to high energy ESD. Therefore, proper ESD precautions should be taken to avoid performance degradation or loss of functionality.

# PIN CONFIGURATION AND FUNCTION DESCRIPTIONS

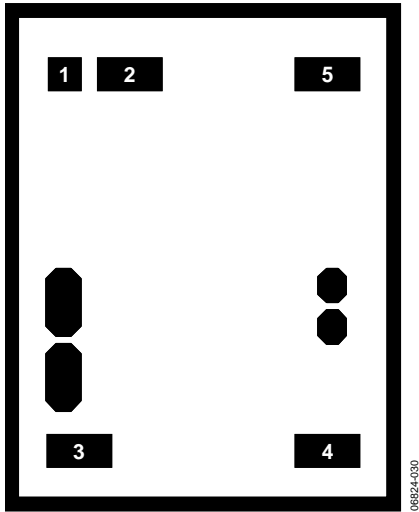

Figure 2. Metallization Diagram

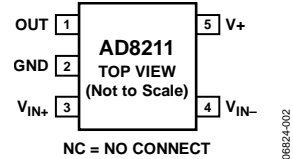

Figure 3. Pin Configuration

Table 3. Pin Function Descriptions

Pin No.	Mnemonic	X	Y	Description
1	OUT	-277	+466	Buffered Output.
2	GND	-140	+466	Ground.
3	V <sub>IN+</sub>	-228	-519	Noninverting Input.
4	V <sub>IN-</sub>	+229	-519	Inverting Input.
5	V+	+264	+466	Supply.

## TYPICAL PERFORMANCE CHARACTERISTICS

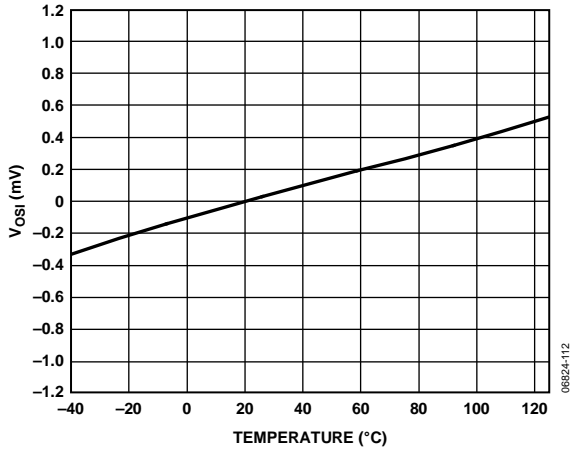

Figure 4. Typical Offset vs. Temperature

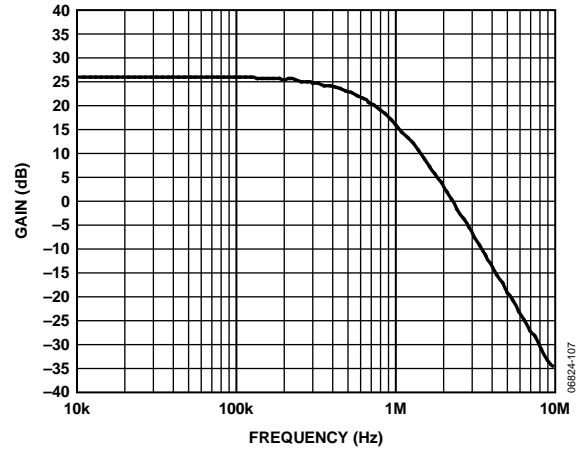

Figure 7. Typical Small Signal Bandwidth ( $V_{OUT} = 200 \text{ mV p-p}$ )

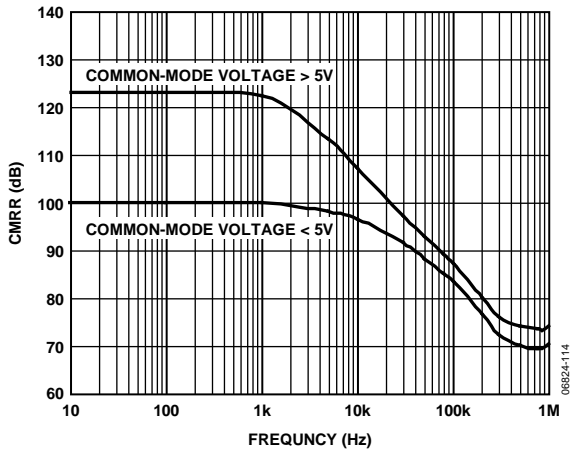

Figure 5. Typical CMRR vs. Frequency

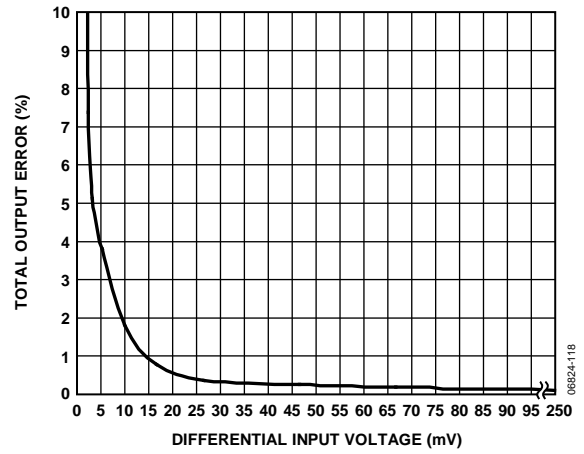

Figure 8. Total Output Error vs. Differential Input Voltage

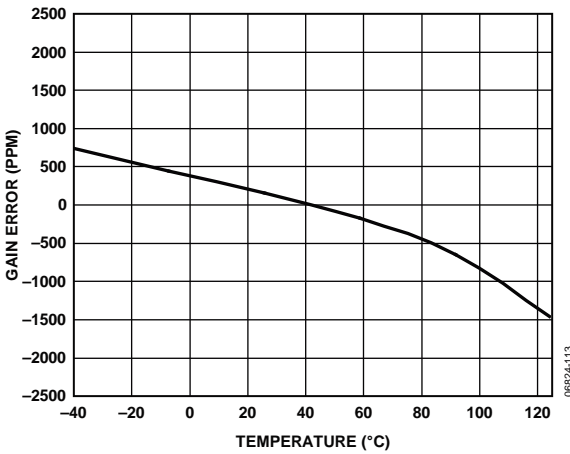

Figure 6. Typical Gain Error vs. Temperature

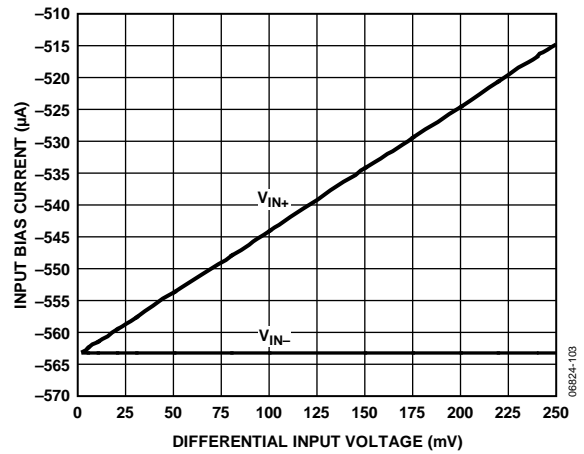

Figure 9. Input Bias Current vs. Differential Input Voltage,  $V_{CM} = 0 \text{ V}$

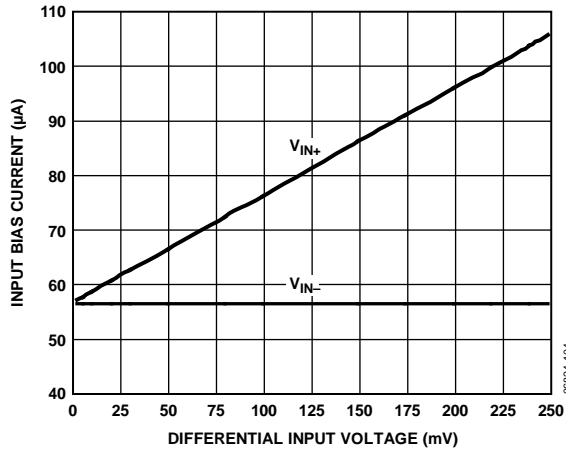

Figure 10. Input Bias Current vs. Differential Input Voltage,  $V_{CM} = 5V$

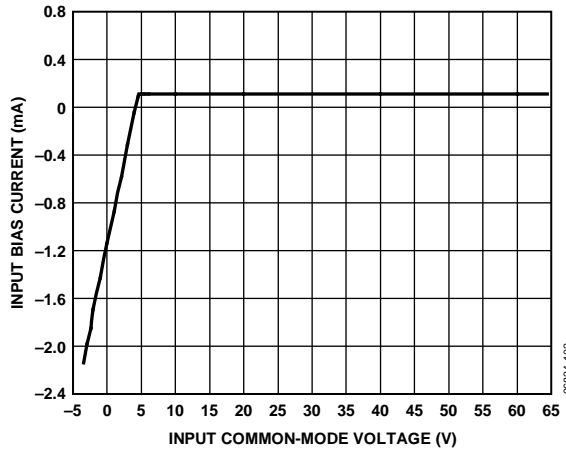

Figure 11. Input Bias Current vs. Input Common-Mode Voltage

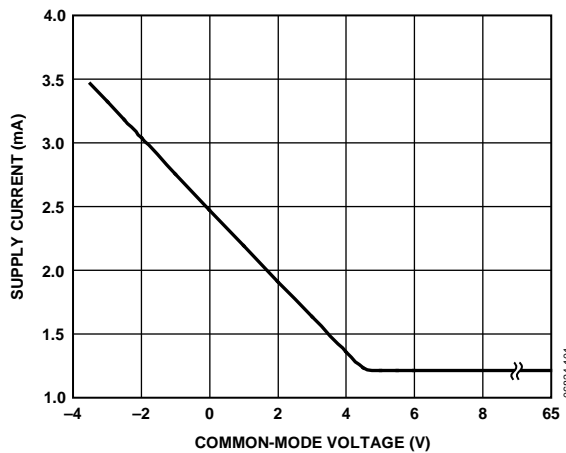

Figure 12. Supply Current vs. Common-Mode Voltage

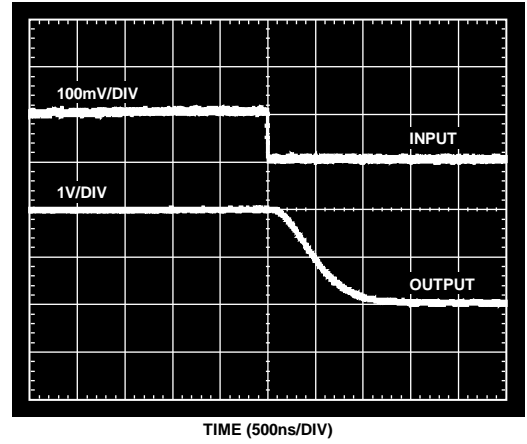

Figure 13. Fall Time

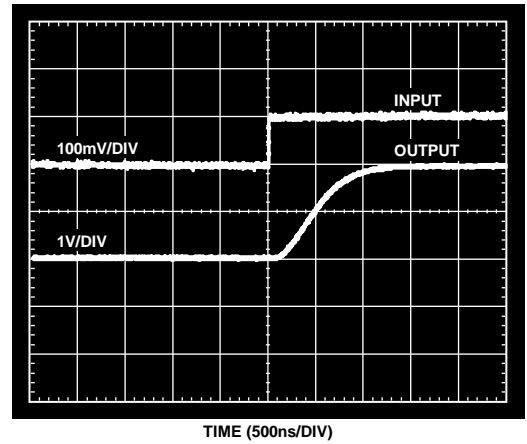

Figure 14. Rise Time

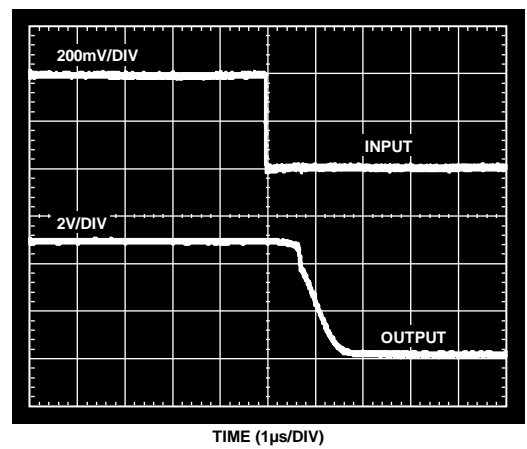

Figure 15. Differential Overload Recovery (Falling)

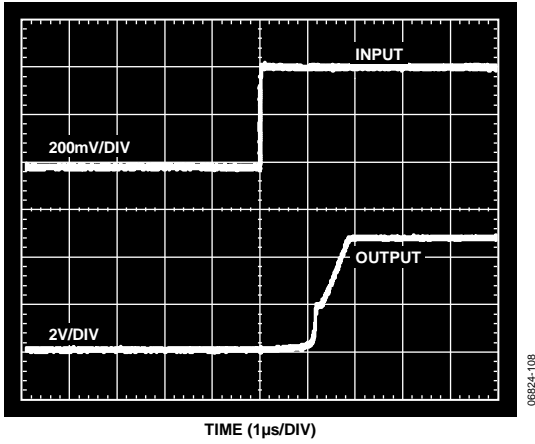

Figure 16. Differential Overload Recovery (Rising)

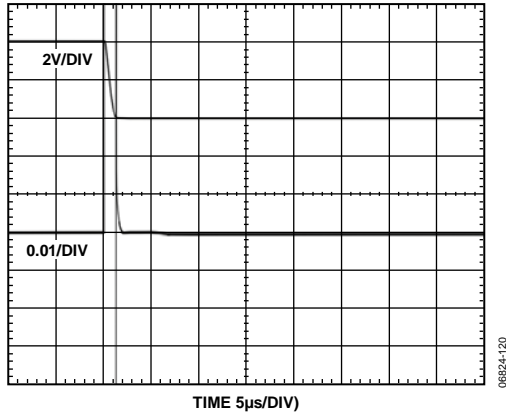

Figure 17. Settling Time (Falling)

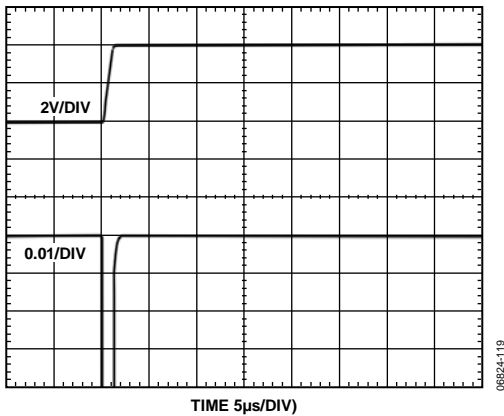

Figure 18. Settling Time (Rising)

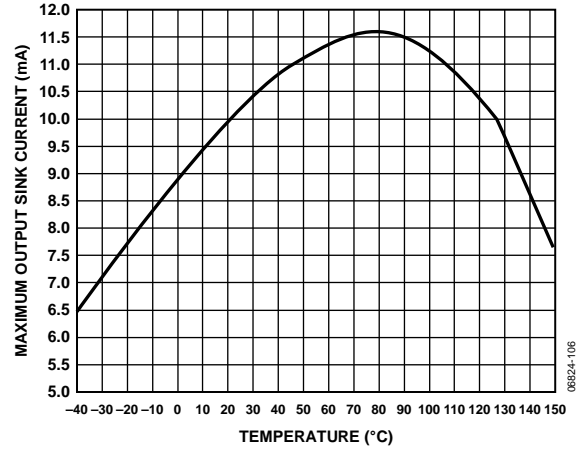

Figure 19. Maximum Output Sink Current vs. Temperature

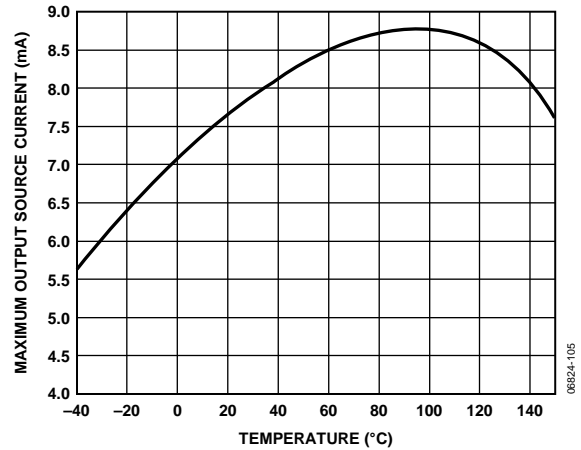

Figure 20. Maximum Output Source Current vs. Temperature

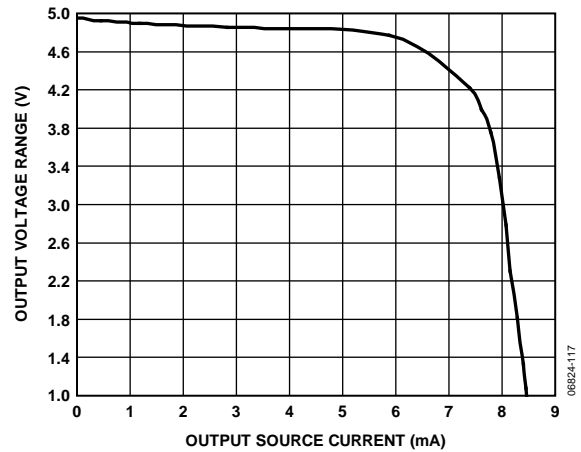

Figure 21. Output Voltage Range vs. Output Source Current



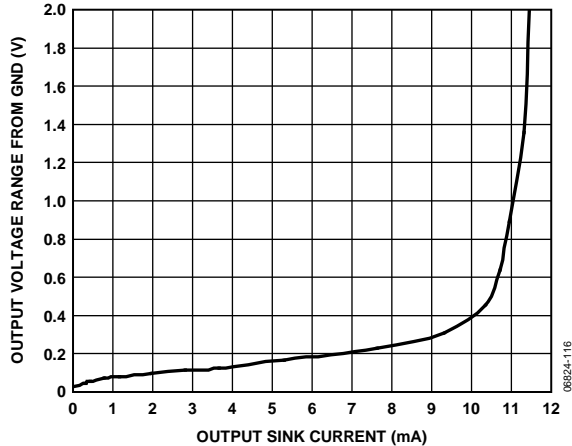

Figure 22. Output Voltage Range from GND vs. Output Sink Current

## THEORY OF OPERATION

In typical applications, the AD8211 amplifies a small differential input voltage generated by the load current flowing through a shunt resistor. The AD8211 rejects high common-mode voltages (up to 65 V) and provides a ground-referenced, buffered output that interfaces with an analog-to-digital converter (ADC). Figure 23 shows a simplified schematic of the AD8211.

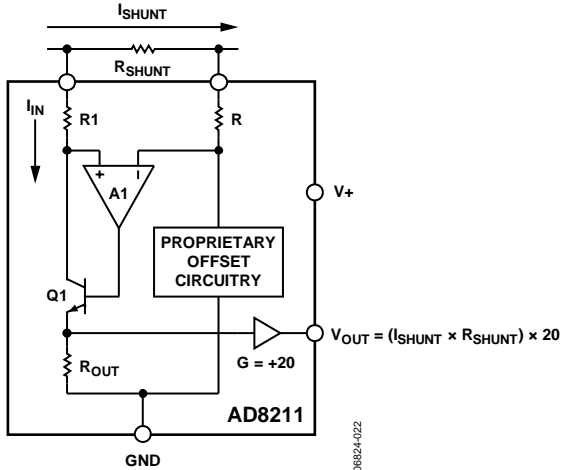

Figure 23. Simplified Schematic

A load current flowing through the external shunt resistor produces a voltage at the input terminals of the AD8211. The input terminals are connected to Amplifier A1 by Resistor R and Resistor R1. The inverting terminal, which has very high input impedance is held to

$$(V_{CM}) - (I_{SHUNT} \times R_{SHUNT})$$

because negligible current flows through Resistor R. Amplifier A1 forces the noninverting input to the same potential. Therefore, the current that flows through Resistor R1, is equal to

$$I_{IN} = (I_{SHUNT} \times R_{SHUNT})/R1$$

This current ( $I_{IN}$ ) is converted back to a voltage via  $R_{OUT}$ . The output buffer amplifier has a gain of 20 V/V and offers excellent accuracy as the internal gain setting resistors are precision trimmed to within 0.01% matching. The resulting output voltage is equal to

$$V_{OUT} = (I_{SHUNT} \times R_{SHUNT}) \times 20$$

## APPLICATION NOTES

### OUTPUT LINEARITY

In all current sensing applications, and especially in automotive and industrial environments where the common-mode voltage can vary significantly, it is important that the current sensor maintain the specified output linearity, regardless of the input differential or common-mode voltage. The AD8211 contains specific circuitry on the input stage, which ensures that even when the differential input voltage is very small, and the common-mode voltage is also low (below the 5 V supply), the input-to-output linearity is maintained. Figure 24 shows the input differential voltage vs. the corresponding output voltage at different common modes.

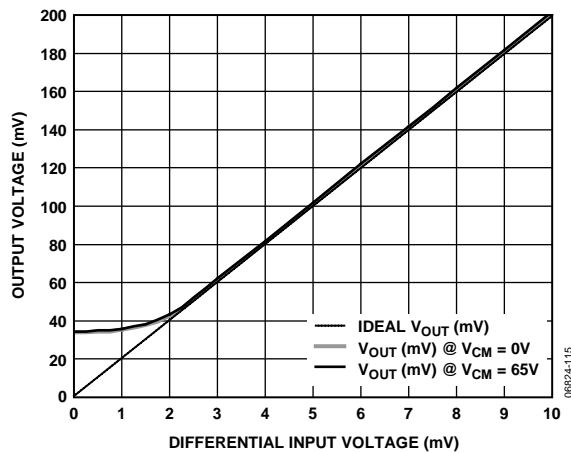

Figure 24. Gain Linearity Due to Differential and Common-Mode Voltage

Regardless of the common mode, the AD8211 provides a correct output voltage when the input differential is at least 2 mV, which is due to the voltage range of the output amplifier that can go as low as 33 mV typical. The specified minimum output amplifier voltage is 100 mV to provide sufficient guard-bands. The ability of the AD8211 to work with very small differential inputs, regardless of the common-mode voltage, allows for more dynamic range, accuracy, and flexibility in any current sensing application.

## APPLICATIONS INFORMATION

### HIGH-SIDE CURRENT SENSE WITH A LOW-SIDE SWITCH

In such load control configurations, the PWM-controlled switch is ground referenced. An inductive load (solenoid) is tied to a power supply. A resistive shunt is placed between the switch and the load (see Figure 25). An advantage of placing the shunt on the high side is that the entire current, including the recirculation current, can be measured because the shunt remains in the loop when the switch is off. In addition, diagnostics can be enhanced because shorts to ground can be detected with the shunt on the high side. In this circuit configuration, when the switch is closed, the common-mode voltage moves down to near the negative rail. When the switch is opened, the voltage reversal across the inductive load causes the common-mode voltage to be held one diode drop above the battery by the clamp diode.

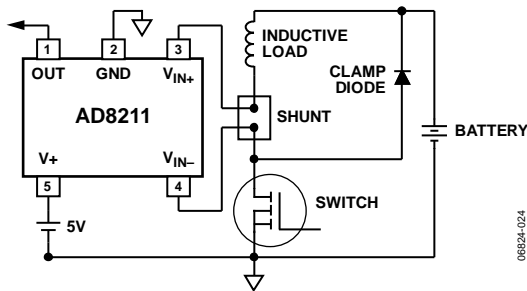

Figure 25. Low-Side Switch

### HIGH-SIDE CURRENT SENSING

In this configuration, the shunt resistor is referenced to the battery. High voltage is present at the inputs of the current sense amplifier. In this mode, the recirculation current is again measured and shorts to ground can be detected. When the shunt is battery referenced, the AD8211 produces a linear ground-referenced analog output. An AD8214 can also be used to provide an over-current detection signal in as little as 100 ns. This feature is useful in high current systems where fast shutdown in over-current conditions is essential.

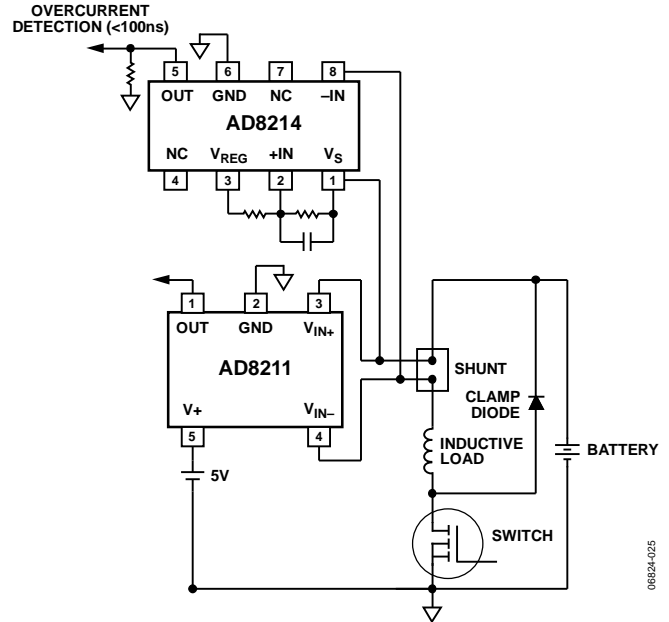

Figure 26. Battery-Referenced Shunt Resistor

### LOW-SIDE CURRENT SENSING

In systems where low-side current sensing is preferred, the AD8211 provides an integrated solution with great accuracy. Ground noise is rejected, CMRR is typically higher than 90 dB, and output linearity is not compromised, regardless of the input differential voltage.

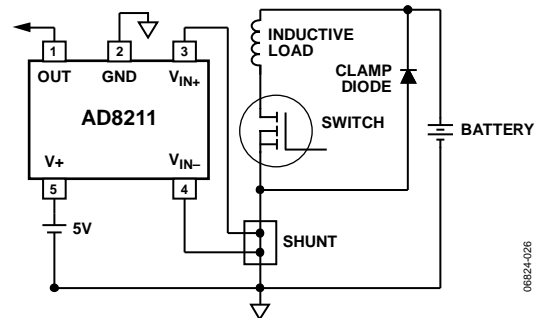
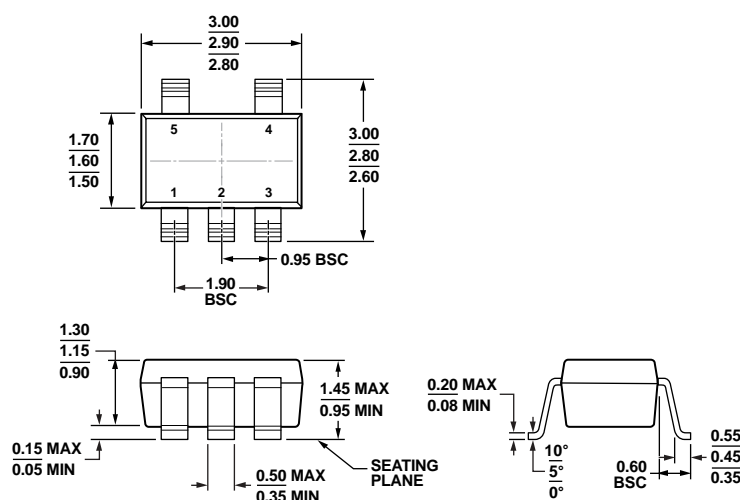

Figure 27. Ground-Referenced Shunt Resistor

## OUTLINE DIMENSIONS



COMPLIANT TO JEDEC STANDARDS MO-178-AA

Figure 28. 5-Lead Small Outline Transistor Package [SOT-23]  
(RJ-5)

Dimensions shown in millimeters

11-01-2016-A

## ORDERING GUIDE

Model <sup>1,2</sup>	Temperature Range	Package Description	Package Option	Branding
AD8211YRJZ-R2	-40°C to +125°C	5-Lead SOT-23	RJ-5	Y02
AD8211YRJZ-RL	-40°C to +125°C	5-Lead SOT-23	RJ-5	Y02
AD8211YRJZ-RL7	-40°C to +125°C	5-Lead SOT-23	RJ-5	Y02
AD8211WYRJZ-R7	-40°C to +125°C	5-Lead SOT-23	RJ-5	Y3N
AD8211WYRJZ-RL	-40°C to +125°C	5-Lead SOT-23	RJ-5	Y3N

<sup>1</sup> Z = RoHS Compliant Part.

<sup>2</sup> W = Qualified for Automotive Applications.

## AUTOMOTIVE PRODUCTS

The AD8211WYRJZ models are available with controlled manufacturing to support the quality and reliability requirements of automotive applications. Note that these automotive models may have specifications that differ from the commercial models; therefore, designers should review the Specifications section of this data sheet carefully. Only the automotive grade products shown are available for use in automotive applications. Contact your local Analog Devices account representative for specific product ordering information and to obtain the specific Automotive Reliability reports for these models.