

## FEATURES

**Fixed gain of 20 dB**  
**Operational frequency of 1 MHz to 2.7 GHz**  
**Linear output power up to 9 dBm**  
**Input/output internally matched to 50  $\Omega$**   
**Temperature and power supply stable**  
**Noise figure: 5.3 dB**  
**Power supply: 3 V or 5 V**

## APPLICATIONS

**VCO buffers**  
**General Tx/Rx amplification**  
**Power amplifier predrivers**  
**Low power antenna drivers**

## GENERAL DESCRIPTION

The [AD8353](#) is a broadband, fixed-gain, linear amplifier that operates at frequencies from 1 MHz up to 2.7 GHz. It is intended for use in a wide variety of wireless devices, including cellular, broadband, CATV, and LMDS/MMDS applications.

By taking advantage of Analog Devices, Inc., high performance, complementary Si bipolar process, these gain blocks provide excellent stability over process, temperature, and power supply. This amplifier is single-ended and internally matched to 50  $\Omega$  with a return loss of greater than 10 dB over the full operating frequency range.

The [AD8353](#) provides linear output power of 9 dBm with 20 dB of gain at 900 MHz when biased at 3 V and an external RF choke is connected between the power supply and the output pin. The dc supply current is 42 mA. At 900 MHz, the output third-order intercept (OIP3) is greater than 23 dBm and is 19 dBm at 2.7 GHz.

## FUNCTIONAL BLOCK DIAGRAM

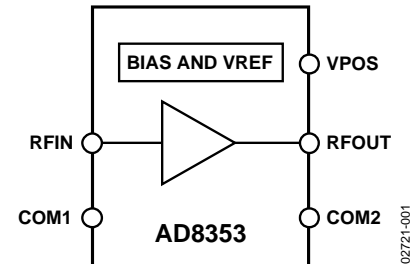

Figure 1.

The noise figure is 5.3 dB at 900 MHz. The reverse isolation ( $S_{12}$ ) is  $-36$  dB at 900 MHz and  $-30$  dB at 2.7 GHz.

The [AD8353](#) can also operate with a 5 V power supply; in which case, no external inductor is required. Under these conditions, the [AD8353](#) delivers 8 dBm with 20 dB of gain at 900 MHz. The dc supply current is 42 mA. At 900 MHz, the OIP3 is greater than 22 dBm and is 19 dBm at 2.7 GHz. The noise figure is 5.6 dB at 900 MHz. The reverse isolation ( $S_{12}$ ) is  $-35$  dB.

The [AD8353](#) is fabricated on Analog Devices proprietary, high performance, 25 GHz, Si complementary, bipolar IC process. The [AD8353](#) is available in a chip scale package that uses an exposed paddle for excellent thermal impedance and low impedance electrical connection to ground. It operates over a  $-40^{\circ}\text{C}$  to  $+85^{\circ}\text{C}$  temperature range, and an evaluation board is also available.

# AD8353\* PRODUCT PAGE QUICK LINKS

Last Content Update: 02/23/2017

---

## COMPARABLE PARTS

View a parametric search of comparable parts.

## EVALUATION KITS

- AD8353 Evaluation Board

## DOCUMENTATION

### Application Notes

- AN-1363: Meeting Biasing Requirements of Externally Biased RF/Microwave Amplifiers with Active Bias Controllers
- AN-1389: Recommended Rework Procedure for the Lead Frame Chip Scale Package (LFCSP)
- AN-772: A Design and Manufacturing Guide for the Lead Frame Chip Scale Package (LFCSP)

### Data Sheet

- AD8353: 1 MHz to 2.7 GHz RF Gain Block Data Sheet

## TOOLS AND SIMULATIONS

- ADI RF Amplifier Library for Agilent ADS
- ADIsimPLL™
- ADIsimRF
- AD8353 S-Parameters

## REFERENCE MATERIALS

### Product Selection Guide

- RF Source Booklet

## DESIGN RESOURCES

- AD8353 Material Declaration
- PCN-PDN Information
- Quality And Reliability
- Symbols and Footprints

## DISCUSSIONS

View all AD8353 EngineerZone Discussions.

## SAMPLE AND BUY

Visit the product page to see pricing options.

## TECHNICAL SUPPORT

Submit a technical question or find your regional support number.

## DOCUMENT FEEDBACK

Submit feedback for this data sheet.

## TABLE OF CONTENTS

Features .....	1	Typical Performance Characteristics .....	7
Applications.....	1	Theory of Operation .....	13
Functional Block Diagram .....	1	Basic Connections.....	13
General Description .....	1	Applications Information .....	14
Revision History .....	2	Low Frequency Applications Below 100 MHz.....	14
Specifications.....	3	Evaluation Board .....	15
Absolute Maximum Ratings.....	5	Outline Dimensions .....	16
ESD Caution.....	5	Ordering Guide .....	16
Pin Configuration and Function Descriptions.....	6		

## REVISION HISTORY

### 2/2017—Rev. E to Rev. F

Changed CP-8-1 to CP-8-23 .....	Throughout
Changes to Figure 2.....	6
Changes to Ordering Guide .....	16
Updated Outline Dimensions .....	16

### 12/2013—Rev. D to Rev. E

Changes to Figure 35.....	12
---------------------------	----

### 9/2013—Rev. C to Rev. D

Changes to Figure 2.....	6
Added EPAD Row, Table 4 .....	6
Added Figure 35; Renumbered Sequentially .....	12
Added Exposed Pad Notation to Outline Dimensions .....	16

### 3/2009—Rev. B to Rev. C

Changes to Lead Temperature (Soldering, 60 sec) Parameter, Table 3 .....	5
Changes to Ordering Guide .....	16

### 12/2005—Rev. A to Rev. B

Changes to Table 1.....	3
Changes to Table 2.....	4
Changes to Figure 16.....	9
Changes to Figure 32.....	11
Moved Figure 39 to Page 15; Renumbered Sequentially.....	15
Changes to Ordering Guide .....	16

### 8/2005—Rev. 0 to Rev. A

Updated Format.....	Universal
Changes to Product Title.....	1
Changes to Features, Figure 1, and General Description.....	1
Changes to Table 1.....	3
Changes to Table 2.....	4
Changes to Figure 2 and Table 4.....	6
Changes to Figure 3 caption and Figure 6 caption.....	7
Changes to Figure 17 caption and Figure 20 caption .....	9
Changes to Basic Connections Section .....	13
Added Low Frequency Applications Below 100 MHz Section.....	14
Changes to Table 5.....	15
Changes to Ordering Guide .....	16
Updated Outline Dimensions .....	16

### 2/2002—Revision 0: Initial Version

## SPECIFICATIONS

$V_S = 3\text{ V}$ ,  $T_A = 25^\circ\text{C}$ , 100 nH external inductor between RFOUT and VPOS,  $Z_0 = 50\ \Omega$ , unless otherwise noted.

Table 1.

Parameter	Test Conditions/Comments	Min	Typ	Max	Unit
<b>OVERALL FUNCTION</b>					
Frequency Range		1		2700	MHz
Gain	f = 900 MHz		19.8		dB
	f = 1.9 GHz		17.7		dB
	f = 2.7 GHz		15.6		dB
Delta Gain	f = 900 MHz, $-40^\circ\text{C} \leq T_A \leq +85^\circ\text{C}$		-0.97		dB
	f = 1.9 GHz, $-40^\circ\text{C} \leq T_A \leq +85^\circ\text{C}$		-1.15		dB
	f = 2.7 GHz, $-40^\circ\text{C} \leq T_A \leq +85^\circ\text{C}$		-1.34		dB
Gain Supply Sensitivity	VPOS $\pm 10\%$ , f = 900 MHz		0.04		dB/V
	f = 1.9 GHz		-0.004		dB/V
	f = 2.7 GHz		-0.04		dB/V
Reverse Isolation ( $S_{12}$ )	f = 900 MHz		-35.6		dB
	f = 1.9 GHz		-34.9		dB
	f = 2.7 GHz		-30.3		dB
<b>RF INPUT INTERFACE</b>					
Input Return Loss	Pin RFIN				
	f = 900 MHz		22.3		dB
	f = 1.9 GHz		20.9		dB
	f = 2.7 GHz		11.2		dB
<b>RF OUTPUT INTERFACE</b>					
Output Compression Point	Pin RFOUT				
	f = 900 MHz, 1 dB compression		9.1		dBm
	f = 1.9 GHz		8.4		dBm
	f = 2.7 GHz		7.6		dBm
Delta Compression Point	f = 900 MHz, $-40^\circ\text{C} \leq T_A \leq +85^\circ\text{C}$		-1.46		dB
	f = 1.9 GHz, $-40^\circ\text{C} \leq T_A \leq +85^\circ\text{C}$		-1.17		dB
	f = 2.7 GHz, $-40^\circ\text{C} \leq T_A \leq +85^\circ\text{C}$		-1		dB
Output Return Loss	f = 900 MHz		26.3		dB
	f = 1.9 GHz		16.9		dB
	f = 2.7 GHz		13.3		dB
<b>DISTORTION/NOISE</b>					
Output Third-Order Intercept	f = 900 MHz, $\Delta f = 1\text{ MHz}$ , $P_{IN} = -28\text{ dBm}$		23.6		dBm
	f = 1.9 GHz, $\Delta f = 1\text{ MHz}$ , $P_{IN} = -28\text{ dBm}$		20.8		dBm
	f = 2.7 GHz, $\Delta f = 1\text{ MHz}$ , $P_{IN} = -28\text{ dBm}$		19.5		dBm
Output Second-Order Intercept	f = 900 MHz, $\Delta f = 1\text{ MHz}$ , $P_{IN} = -28\text{ dBm}$		31.6		dBm
Noise Figure	f = 900 MHz		5.3		dB
	f = 1.9 GHz		6		dB
	f = 2.7 GHz		6.8		dB
<b>POWER INTERFACE</b>					
Supply Voltage	Pin VPOS	2.7	3	3.3	V
Total Supply Current		35	41	48	mA
Supply Voltage Sensitivity			15.3		mA/V
Temperature Sensitivity	$-40^\circ\text{C} \leq T_A \leq +85^\circ\text{C}$		60		$\mu\text{A}/^\circ\text{C}$

$V_S = 5\text{ V}$ ,  $T_A = 25^\circ\text{C}$ , no external inductor between RFOUT and VPOS,  $Z_O = 50\ \Omega$ , unless otherwise noted.

Table 2.

Parameter	Test Conditions/Comments	Min	Typ	Max	Unit
<b>OVERALL FUNCTION</b>					
Frequency Range		1		2700	MHz
Gain	$f = 900\text{ MHz}$		19.5		dB
	$f = 1.9\text{ GHz}$		17.6		dB
	$f = 2.7\text{ GHz}$		15.7		dB
Delta Gain	$f = 900\text{ MHz}$ , $-40^\circ\text{C} \leq T_A \leq +85^\circ\text{C}$		-0.96		dB
	$f = 1.9\text{ GHz}$ , $-40^\circ\text{C} \leq T_A \leq +85^\circ\text{C}$		-1.18		dB
	$f = 2.7\text{ GHz}$ , $-40^\circ\text{C} \leq T_A \leq +85^\circ\text{C}$		-1.38		dB
Gain Supply Sensitivity	VPOS $\pm 10\%$ , $f = 900\text{ MHz}$		0.09		dB/V
	$f = 1.9\text{ GHz}$		-0.01		dB/V
	$f = 2.7\text{ GHz}$		-0.09		dB/V
Reverse Isolation ( $S_{12}$ )	$f = 900\text{ MHz}$		-35.4		dB
	$f = 1.9\text{ GHz}$		-34.6		dB
	$f = 2.7\text{ GHz}$		-30.2		dB
<b>RF INPUT INTERFACE</b>					
Input Return Loss	Pin RFIN				
	$f = 900\text{ MHz}$		22.9		dB
	$f = 1.9\text{ GHz}$		21.7		dB
	$f = 2.7\text{ GHz}$		11.5		dB
<b>RF OUTPUT INTERFACE</b>					
Output Compression Point	Pin RFOUT				
	$f = 900\text{ MHz}$		8.3		dBm
	$f = 1.9\text{ GHz}$		8.1		dBm
	$f = 2.7\text{ GHz}$		7.5		dBm
Delta Compression Point	$f = 900\text{ MHz}$ , $-40^\circ\text{C} \leq T_A \leq +85^\circ\text{C}$		-1.05		dB
	$f = 1.9\text{ GHz}$ , $-40^\circ\text{C} \leq T_A \leq +85^\circ\text{C}$		-1.49		dB
	$f = 2.7\text{ GHz}$ , $-40^\circ\text{C} \leq T_A \leq +85^\circ\text{C}$		-1.33		dB
Output Return Loss	$f = 900\text{ MHz}$		27		dB
	$f = 1.9\text{ GHz}$		22		dB
	$f = 2.7\text{ GHz}$		14.3		dB
<b>DISTORTION/NOISE</b>					
Output Third-Order Intercept	$f = 900\text{ MHz}$ , $\Delta f = 1\text{ MHz}$ , $P_{IN} = -28\text{ dBm}$		22.8		dBm
	$f = 1.9\text{ GHz}$ , $\Delta f = 1\text{ MHz}$ , $P_{IN} = -28\text{ dBm}$		20.6		dBm
	$f = 2.7\text{ GHz}$ , $\Delta f = 1\text{ MHz}$ , $P_{IN} = -28\text{ dBm}$		19.5		dBm
Output Second-Order Intercept	$f = 900\text{ MHz}$ , $\Delta f = 1\text{ MHz}$ , $P_{IN} = -28\text{ dBm}$		30.3		dBm
Noise Figure	$f = 900\text{ MHz}$		5.6		dB
	$f = 1.9\text{ GHz}$		6.3		dB
	$f = 2.7\text{ GHz}$		7.1		dB
<b>POWER INTERFACE</b>					
Supply Voltage	Pin VPOS	4.5	5	5.5	V
Total Supply Current		35	42	52	mA
Supply Voltage Sensitivity			4.3		mA/V
Temperature Sensitivity	$-40^\circ\text{C} \leq T_A \leq +85^\circ\text{C}$		45.7		$\mu\text{A}/^\circ\text{C}$

## ABSOLUTE MAXIMUM RATINGS

Table 3.

Parameter	Rating
Supply Voltage, VPOS	5.5 V
Input Power (re: 50 $\Omega$ )	10 dBm
Equivalent Voltage	700 mV rms
Internal Power Dissipation	
Paddle Not Soldered	325 mW
Paddle Soldered	812 mW
$\theta_{JA}$ (Paddle Soldered)	80°C/W
$\theta_{JA}$ (Paddle Not Soldered)	200°C/W
Maximum Junction Temperature	150°C
Operating Temperature Range	-40°C to +85°C
Storage Temperature Range	-65°C to +150°C
Lead Temperature (Soldering, 60 sec)	260°C

Stresses at or above those listed under Absolute Maximum Ratings may cause permanent damage to the product. This is a stress rating only; functional operation of the product at these or any other conditions above those indicated in the operational section of this specification is not implied. Operation beyond the maximum operating conditions for extended periods may affect product reliability.

### ESD CAUTION



**ESD (electrostatic discharge) sensitive device.** Charged devices and circuit boards can discharge without detection. Although this product features patented or proprietary protection circuitry, damage may occur on devices subjected to high energy ESD. Therefore, proper ESD precautions should be taken to avoid performance degradation or loss of functionality.

## PIN CONFIGURATION AND FUNCTION DESCRIPTIONS

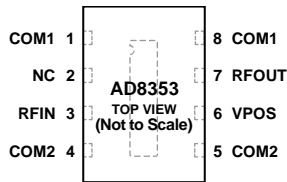

**NOTES**

1. NC = NO CONNECT. DO NOT CONNECT TO THIS PIN.
2. THE EXPOSED PAD MUST BE CONNECTED TO A LOW IMPEDANCE GROUND PAD.

02721-002

Figure 2. Pin Configuration

Table 4. Pin Function Descriptions

Pin No.	Mnemonic	Description
1, 8	COM1	Device Common. Connect to low impedance ground.
2	NC	No Connection.
3	RFIN	RF Input Connection. Must be ac-coupled.
4, 5	COM2	Device Common. Connect to low impedance ground.
6	VPOS	Positive Supply Voltage.
7	RFOUT	RF Output Connection. Must be ac-coupled.
	EPAD	Exposed Pad. The exposed pad must be connected to a low impedance ground pad.

TYPICAL PERFORMANCE CHARACTERISTICS

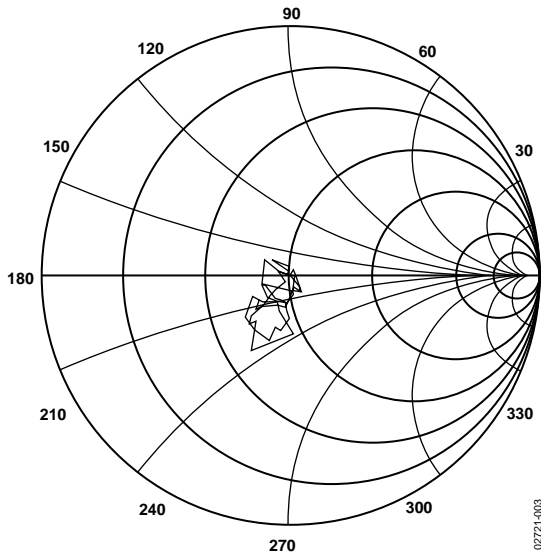

Figure 3.  $S_{11}$  vs. Frequency,  $V_S = 3\text{ V}$ ,  $T_A = 25^\circ\text{C}$ ,  $dc \leq f \leq 3\text{ GHz}$

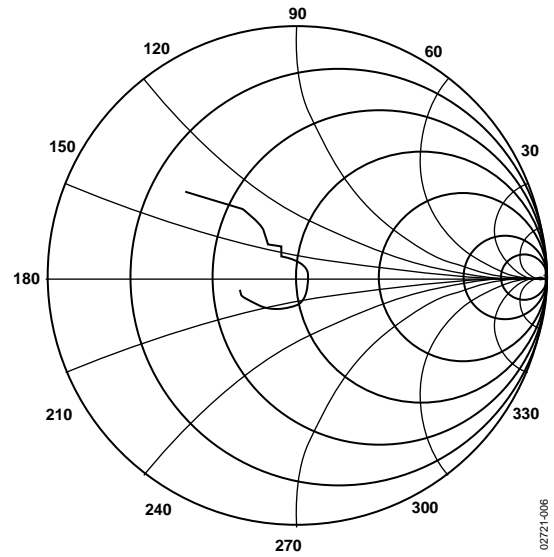

Figure 6.  $S_{22}$  vs. Frequency,  $V_S = 3\text{ V}$ ,  $T_A = 25^\circ\text{C}$ ,  $dc \leq f \leq 3\text{ GHz}$

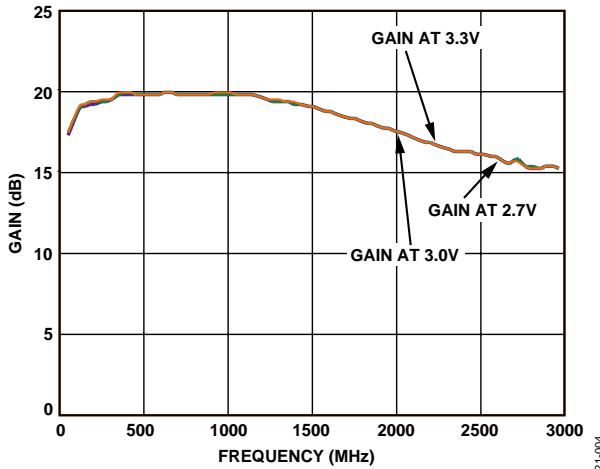

Figure 4. Gain vs. Frequency,  $V_S = 2.7\text{ V}$ ,  $3\text{ V}$ , and  $3.3\text{ V}$ ,  $T_A = 25^\circ\text{C}$

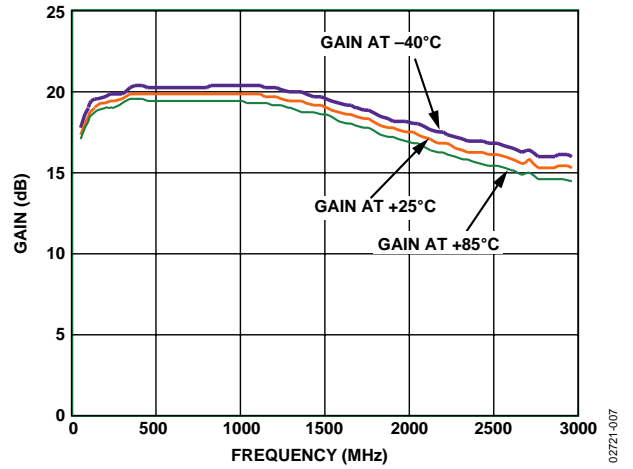

Figure 7. Gain vs. Frequency,  $V_S = 3\text{ V}$ ,  $T_A = -40^\circ\text{C}$ ,  $+25^\circ\text{C}$ , and  $+85^\circ\text{C}$

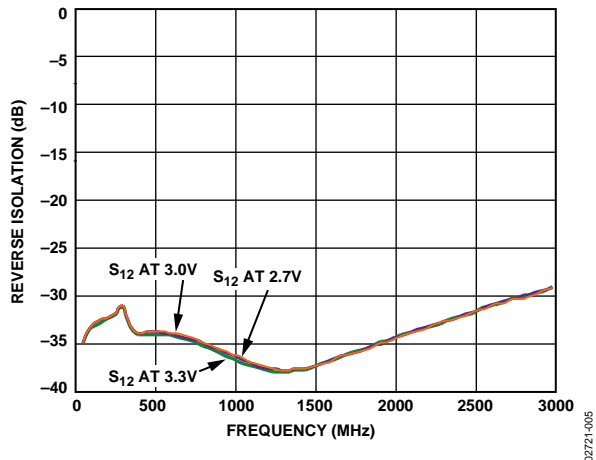

Figure 5. Reverse Isolation vs. Frequency,  $V_S = 2.7\text{ V}$ ,  $3\text{ V}$ , and  $3.3\text{ V}$ ,  $T_A = 25^\circ\text{C}$

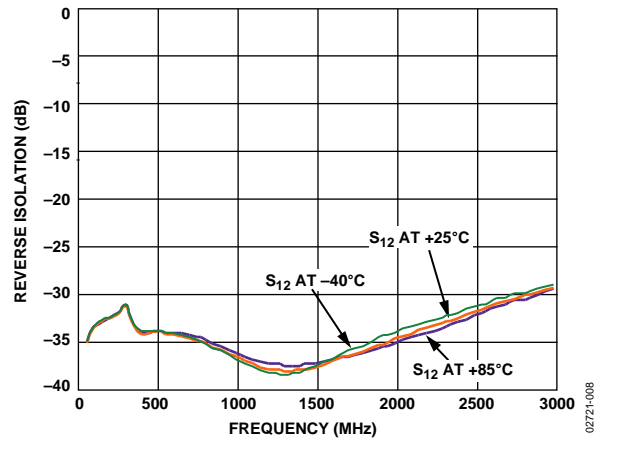

Figure 8. Reverse Isolation vs. Frequency,  $V_S = 3\text{ V}$ ,  $T_A = -40^\circ\text{C}$ ,  $+25^\circ\text{C}$ , and  $+85^\circ\text{C}$



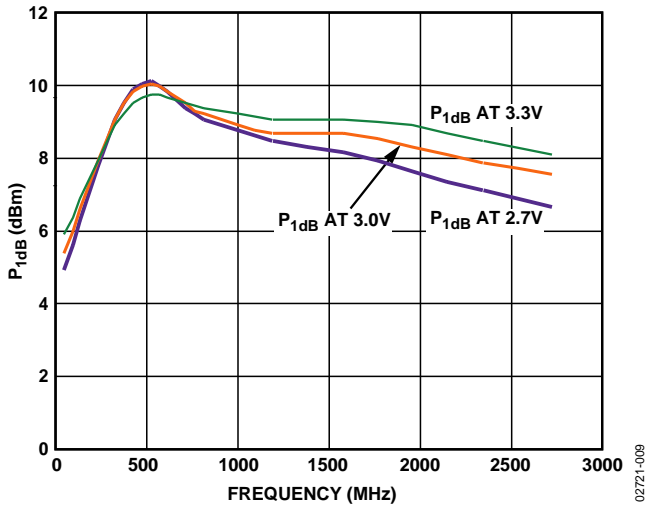

Figure 9.  $P_{1dB}$  vs. Frequency,  $V_S = 2.7V, 3V, \text{ and } 3.3V, T_A = 25^\circ C$

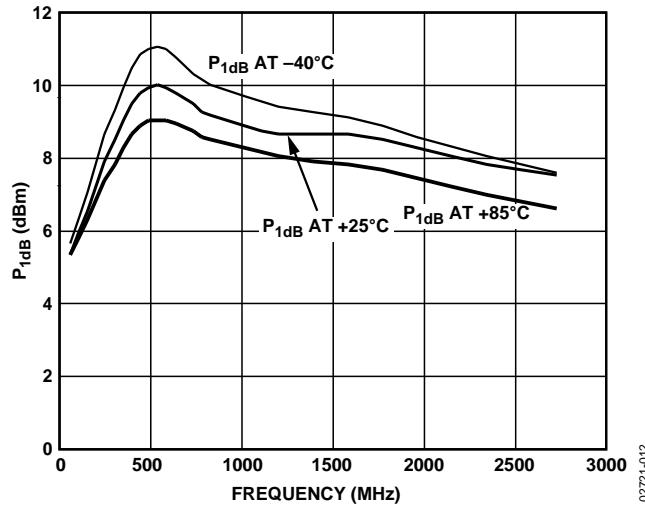

Figure 12.  $P_{1dB}$  vs. Frequency,  $V_S = 3V, T_A = -40^\circ C, +25^\circ C, \text{ and } +85^\circ C$

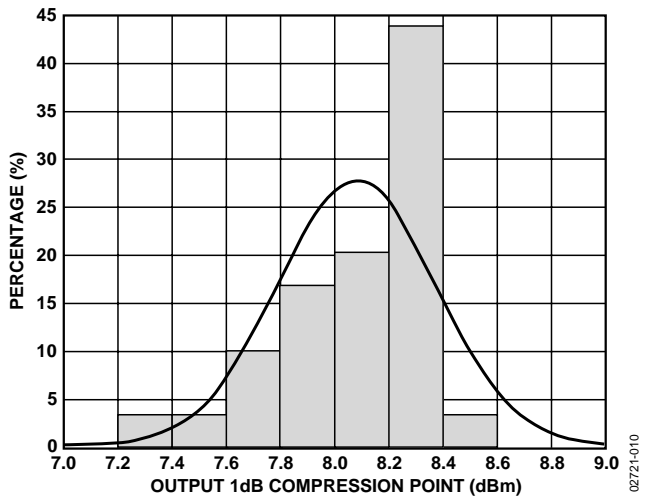

Figure 10. Distribution of  $P_{1dB}$ ,  $V_S = 3V, T_A = 25^\circ C, f = 2.2 GHz$

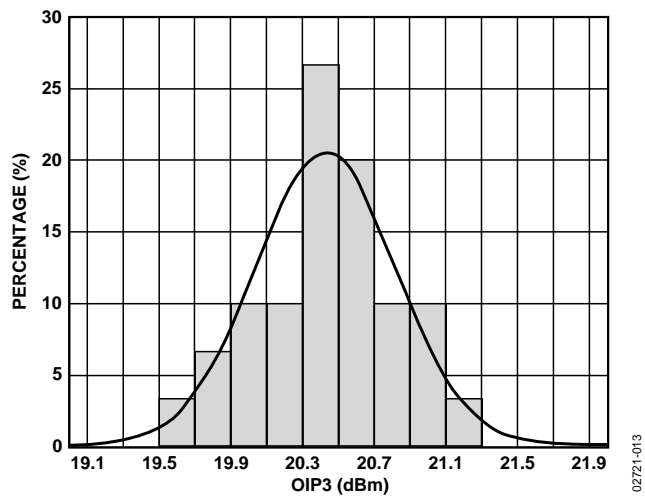

Figure 13. Distribution of  $OIP3$ ,  $V_S = 3V, T_A = 25^\circ C, f = 2.2 GHz$

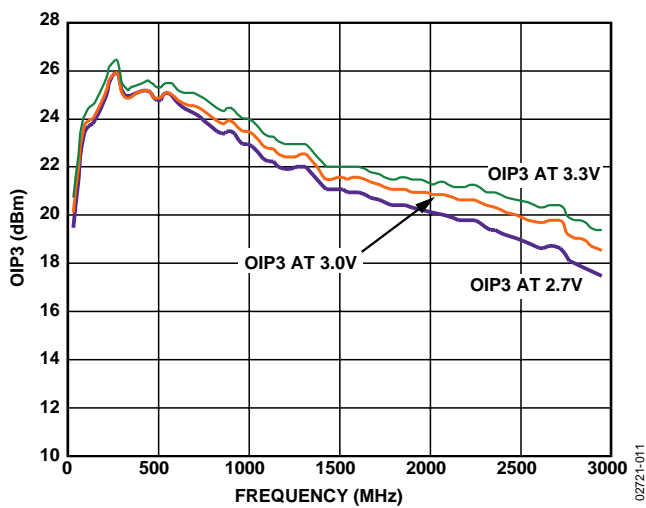

Figure 11.  $OIP3$  vs. Frequency,  $V_S = 2.7V, 3V, \text{ and } 3.3V, T_A = 25^\circ C$

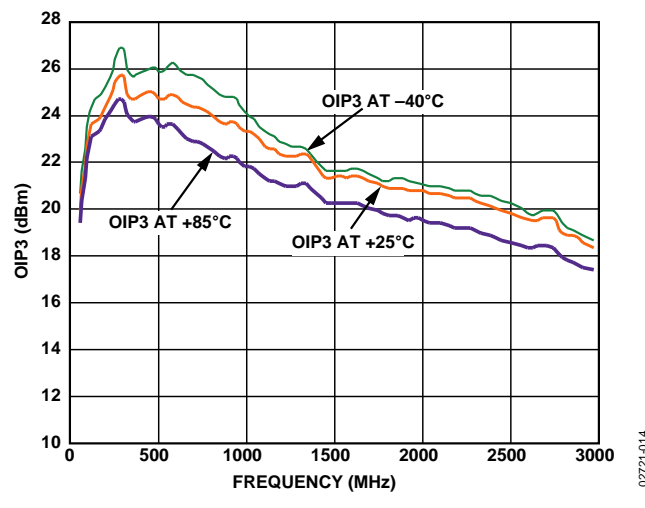
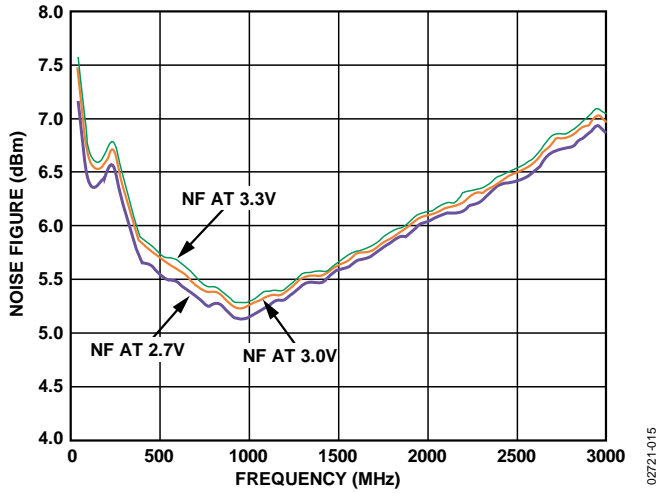
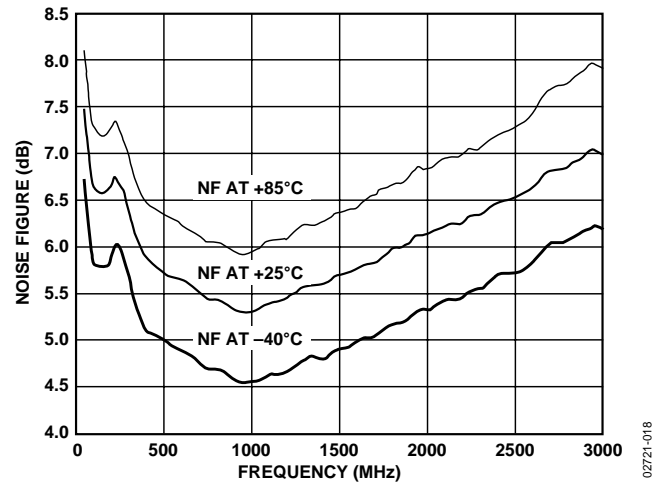

Figure 14.  $OIP3$  vs. Frequency,  $V_S = 3V, T_A = -40^\circ C, +25^\circ C, \text{ and } +85^\circ C$



02721-015

Figure 15. Noise Figure vs. Frequency,  $V_S = 2.7\text{ V}$ ,  $3\text{ V}$ , and  $3.3\text{ V}$ ,  $T_A = 25^\circ\text{C}$



02721-018

Figure 18. Noise Figure vs. Frequency,  $V_S = 3\text{ V}$ ,  $T_A = -40^\circ\text{C}$ ,  $+25^\circ\text{C}$ , and  $+85^\circ\text{C}$

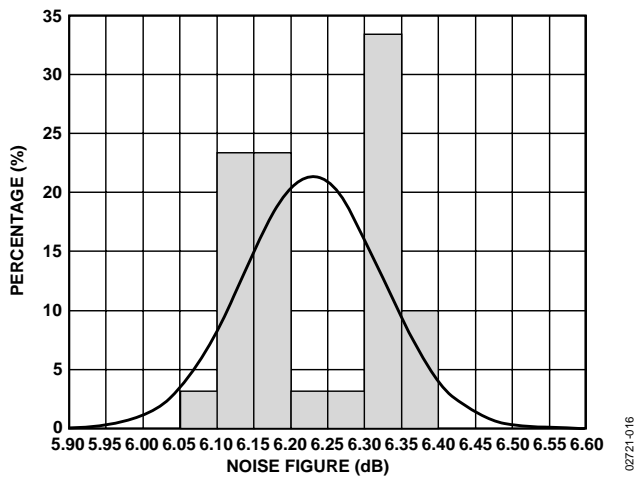

02721-016

Figure 16. Distribution of Noise Figure,  $V_S = 3\text{ V}$ ,  $T_A = 25^\circ\text{C}$ ,  $f = 2.2\text{ GHz}$

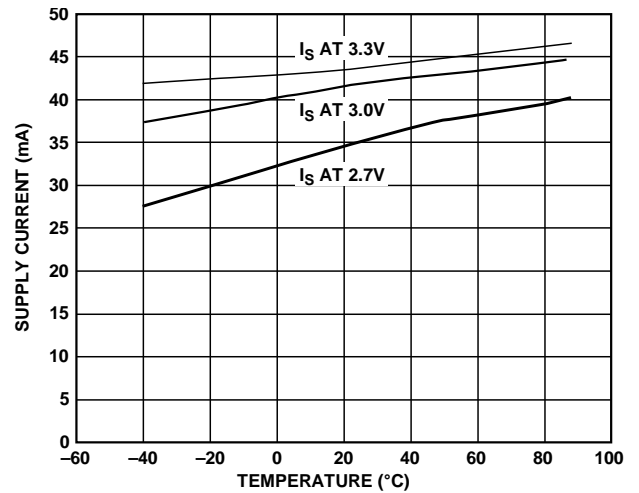

02721-019

Figure 19. Supply Current vs. Temperature,  $V_S = 2.7\text{ V}$ ,  $3\text{ V}$ , and  $3.3\text{ V}$

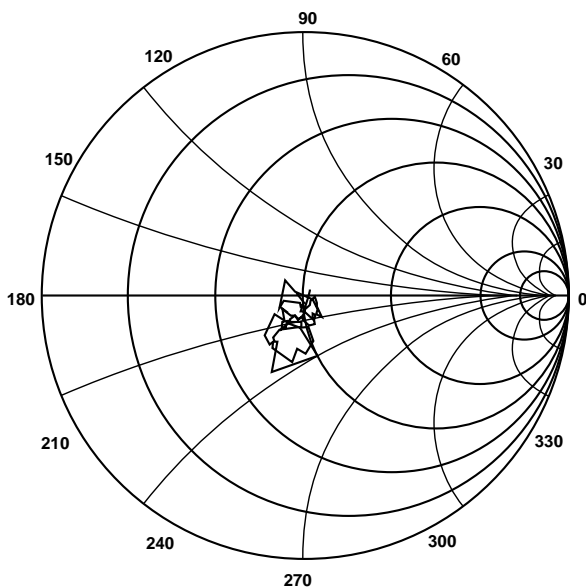

02721-017

Figure 17.  $S_{11}$  vs. Frequency,  $V_S = 5\text{ V}$ ,  $T_A = 25^\circ\text{C}$ ,  $dc \leq f \leq 3\text{ GHz}$

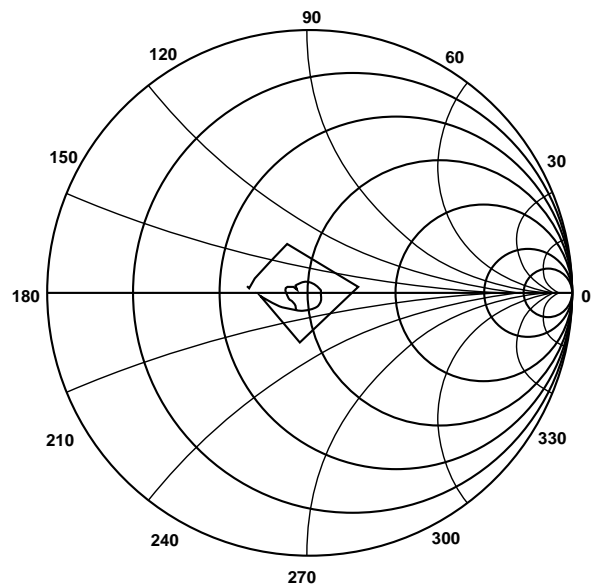

02721-020

Figure 20.  $S_{22}$  vs. Frequency,  $V_S = 5\text{ V}$ ,  $T_A = 25^\circ\text{C}$ ,  $dc \leq f \leq 3\text{ GHz}$

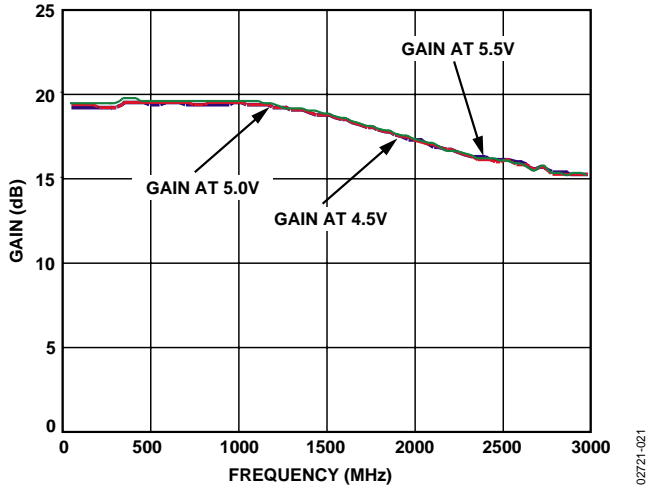

Figure 21. Gain vs. Frequency,  $V_S = 4.5\text{ V}, 5\text{ V}, \text{ and } 5.5\text{ V}, T_A = 25^\circ\text{C}$

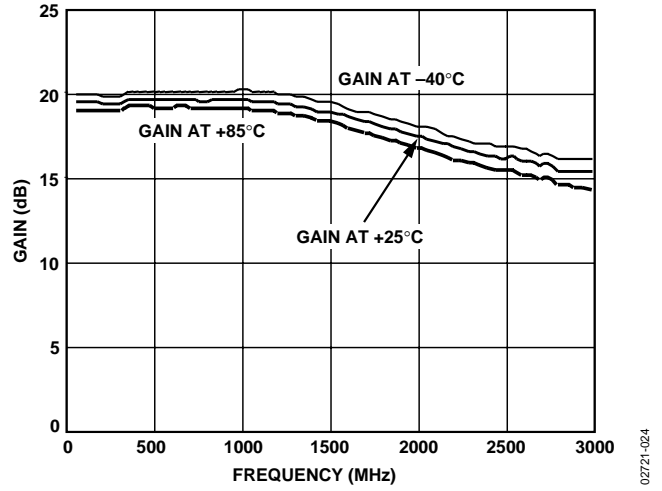

Figure 24. Gain vs. Frequency,  $V_S = 5\text{ V}, T_A = -40^\circ\text{C}, +25^\circ\text{C}, \text{ and } +85^\circ\text{C}$

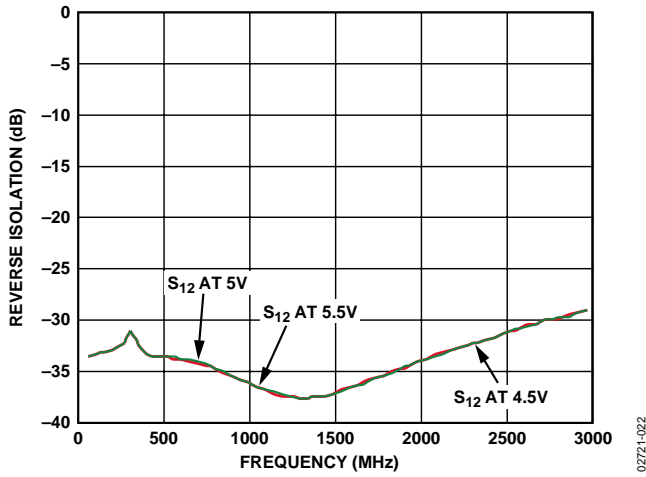

Figure 22. Reverse Isolation vs. Frequency,  $V_S = 4.5\text{ V}, 5\text{ V}, \text{ and } 5.5\text{ V}, T_A = 25^\circ\text{C}$

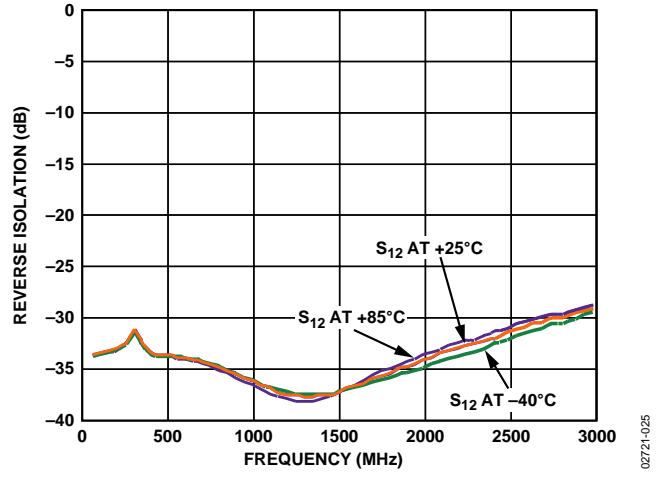

Figure 25. Reverse Isolation vs. Frequency,  $V_S = 5\text{ V}, T_A = -40^\circ\text{C}, +25^\circ\text{C}, \text{ and } +85^\circ\text{C}$

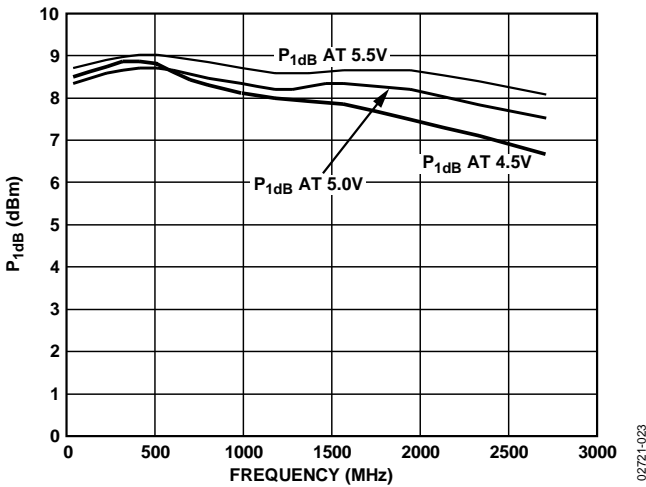

Figure 23.  $P_{1dB}$  vs. Frequency,  $V_S = 4.5\text{ V}, 5\text{ V}, \text{ and } 5.5\text{ V}, T_A = 25^\circ\text{C}$

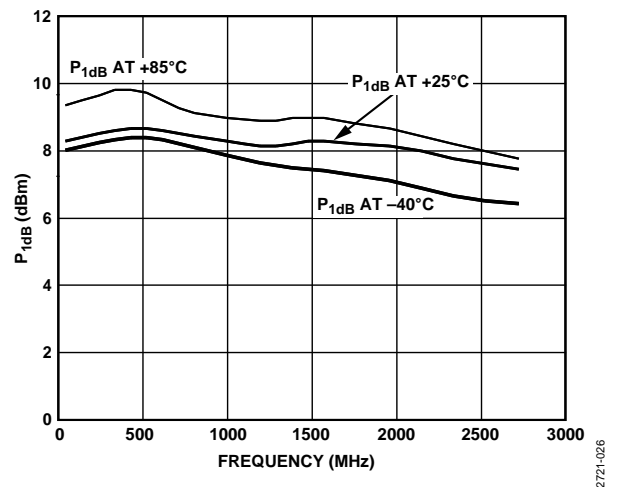

Figure 26.  $P_{1dB}$  vs. Frequency,  $V_S = 5\text{ V}, T_A = -40^\circ\text{C}, +25^\circ\text{C}, \text{ and } +85^\circ\text{C}$

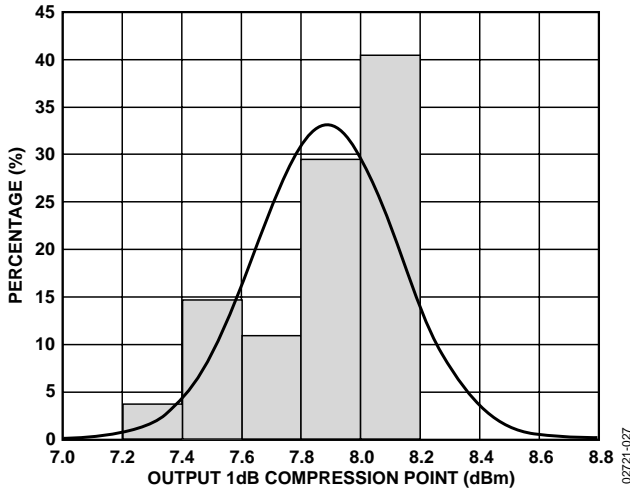

Figure 27. Distribution of  $P_{1dB}$ ,  $V_S = 3\text{ V}$ ,  $T_A = 25^\circ\text{C}$ ,  $f = 2.2\text{ GHz}$

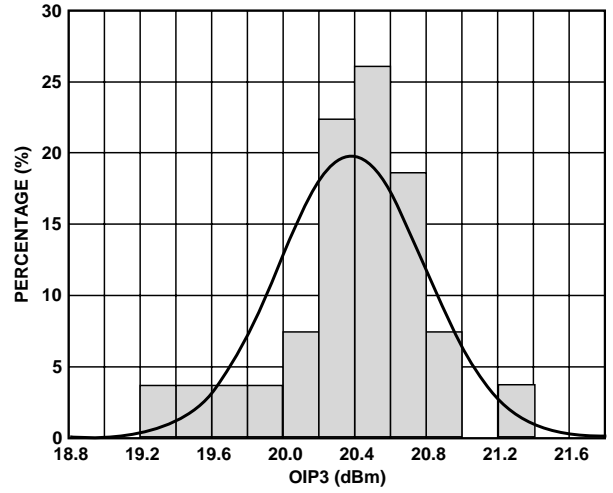

Figure 30. Distribution of OIP3,  $V_S = 5\text{ V}$ ,  $T_A = 25^\circ\text{C}$ ,  $f = 2.2\text{ GHz}$

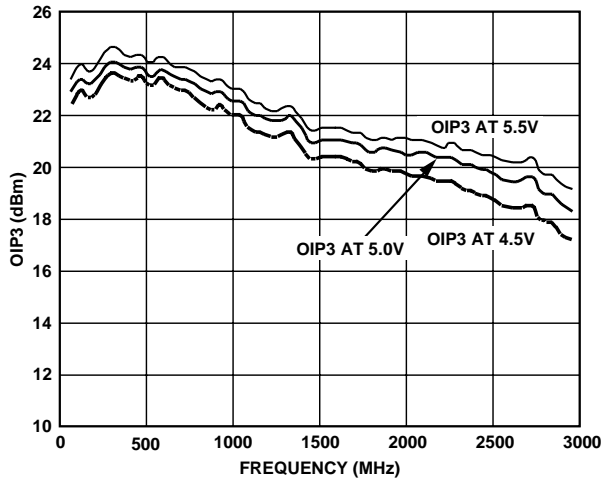

Figure 28. OIP3 vs. Frequency,  $V_S = 4.5\text{ V}$ ,  $5\text{ V}$ , and  $5.5\text{ V}$ ,  $T_A = 27^\circ\text{C}$

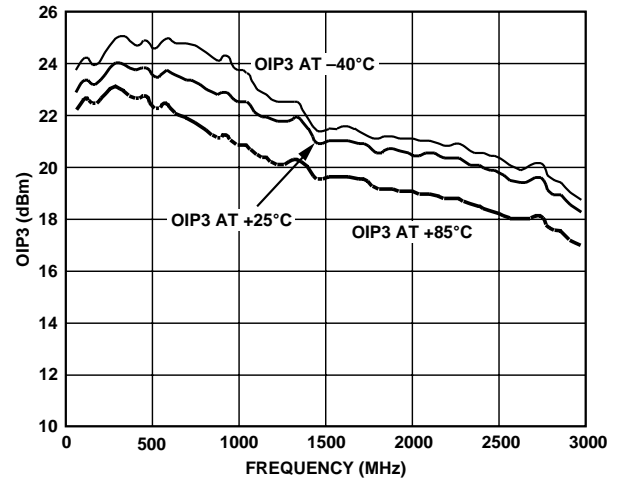

Figure 31. OIP3 vs. Frequency,  $V_S = 5\text{ V}$ ,  $T_A = -40^\circ\text{C}$ ,  $+25^\circ\text{C}$ , and  $+85^\circ\text{C}$

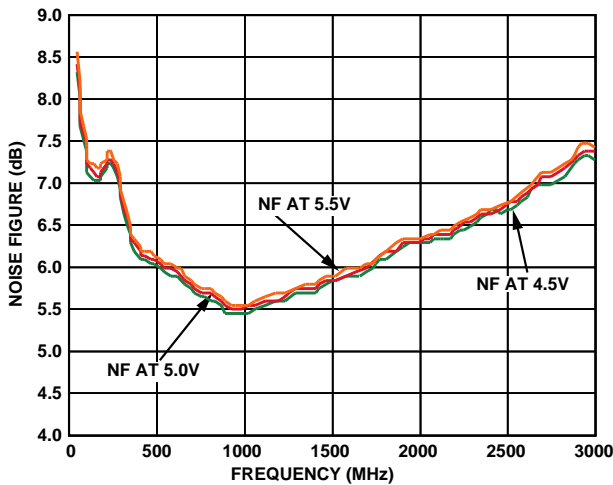

Figure 29. Noise Figure vs. Frequency,  $V_S = 4.5\text{ V}$ ,  $5\text{ V}$ , and  $5.5\text{ V}$ ,  $T_A = 25^\circ\text{C}$

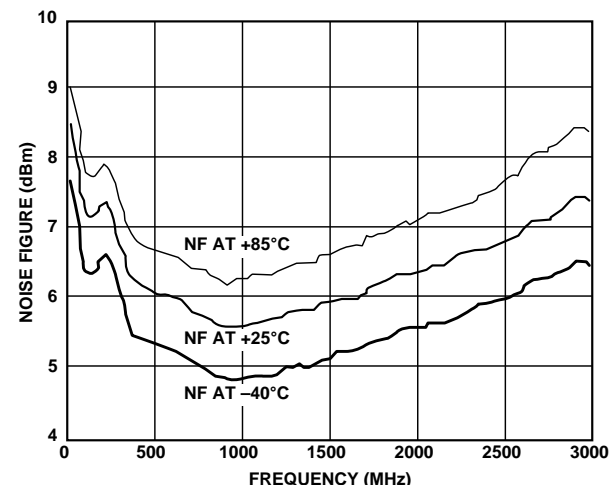

Figure 32. Noise Figure vs. Frequency,  $V_S = 5\text{ V}$ ,  $T_A = -40^\circ\text{C}$ ,  $+25^\circ\text{C}$ , and  $+85^\circ\text{C}$

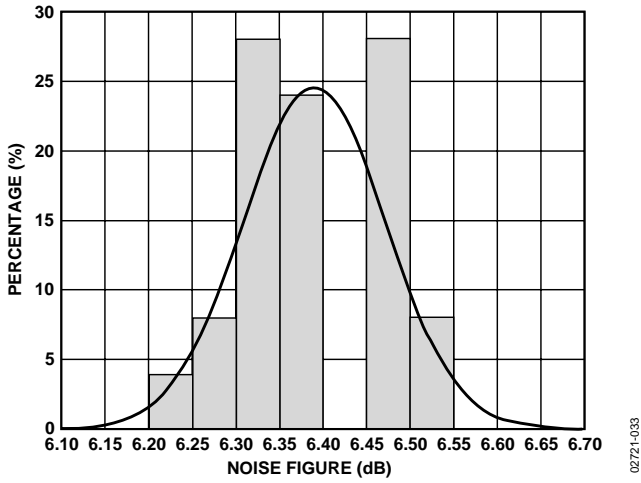

Figure 33. Distribution of Noise Figure,  $V_S = 5\text{ V}$ ,  $T_A = 25^\circ\text{C}$ ,  $f = 2.2\text{ GHz}$

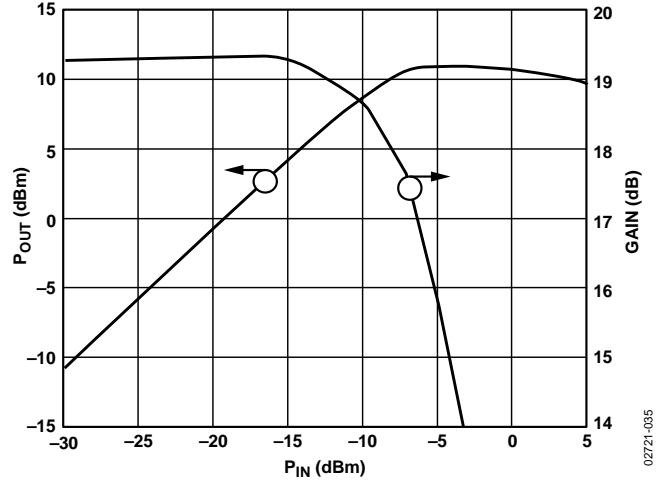

Figure 36. Output Power and Gain vs. Input Power,  $V_S = 3\text{ V}$ ,  $T_A = 25^\circ\text{C}$ ,  $f = 900\text{ MHz}$

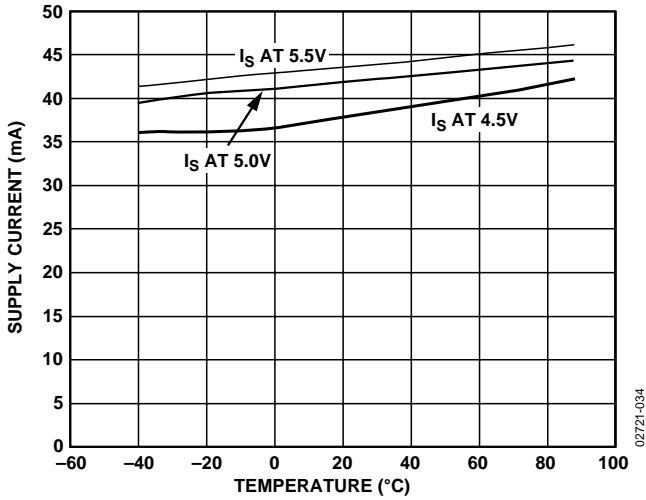

Figure 34. Supply Current vs. Temperature,  $V_S = 4.5\text{ V}$ ,  $5\text{ V}$ , and  $5.5\text{ V}$

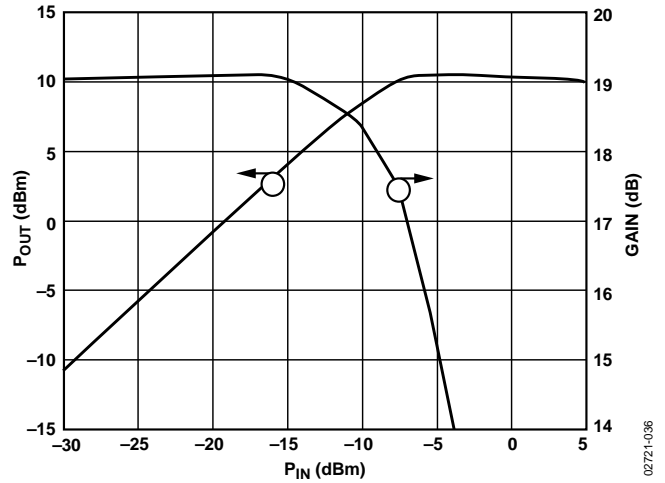

Figure 37. Output Power and Gain vs. Input Power,  $V_S = 5\text{ V}$ ,  $T_A = 25^\circ\text{C}$ ,  $f = 900\text{ MHz}$

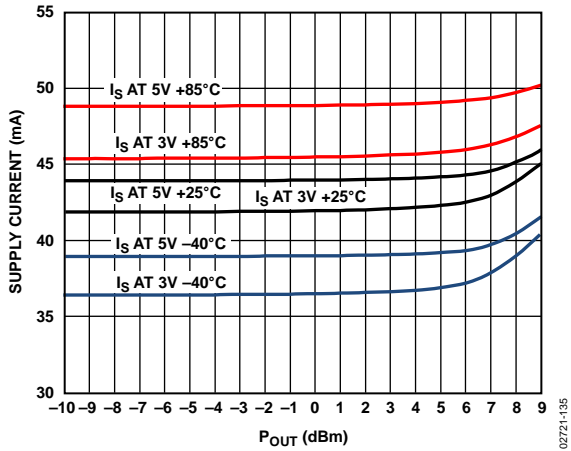

Figure 35. Supply Current vs. Temperature,  $V_S = 3\text{ V}$  and  $5\text{ V}$  Frequency =  $900\text{ MHz}$

## THEORY OF OPERATION

The AD8353 is a 2-stage, feedback amplifier employing both shunt-series and shunt-shunt feedback. The first stage is degenerated and resistively loaded and provides approximately 10 dB of gain. The second stage is a PNP-NPN Darlington output stage, which provides another 10 dB of gain. Series-shunt feedback from the emitter of the output transistor sets the input impedance to 50  $\Omega$  over a broad frequency range. Shunt-shunt feedback from the amplifier output to the input of the Darlington stage helps to set the output impedance to 50  $\Omega$ . The amplifier can be operated from a 3 V supply by adding a choke inductor from the amplifier output to VPOS. Without this choke inductor, operation from a 5 V supply is also possible.

### BASIC CONNECTIONS

The AD8353 RF gain block is a fixed gain amplifier with single-ended input and output ports whose impedances are nominally equal to 50  $\Omega$  over the frequency range 1 MHz to 2.7 GHz. Consequently, it can be directly inserted into a 50  $\Omega$  system with no impedance matching circuitry required. The input and output impedances are sufficiently stable vs. variations in temperature and supply voltage that no impedance matching compensation is required. A complete set of scattering parameters is available at <http://www.analog.com>.

The input pin (RFIN) is connected directly to the base of the first amplifier stage, which is internally biased to approximately 1 V; therefore, a dc blocking capacitor should be connected between the source that drives the AD8353 and the input pin, RFIN.

It is critical to supply very low inductance ground connections to the ground pins (Pin 1, Pin 4, Pin 5, and Pin 8) as well as to the backside exposed paddle. This ensures stable operation.

The AD8353 is designed to operate over a wide supply voltage range, from 2.7 V to 5.5 V. The output of the part, RFOUT, is taken directly from the collector of the output amplifier stage. This node is internally biased to approximately 2.2 V when the supply voltage is 5 V. Consequently, a dc blocking capacitor should be connected between the output pin, RFOUT, and the load that it drives. The value of this capacitor is not critical, but it should be 100 pF or larger.

When the supply voltage is 3 V, it is recommended that an external RF choke be connected between the supply voltage and the output pin, RFOUT. This increases the dc voltage applied to the collector of the output amplifier stage, which improves performance of the AD8353 to be very similar to the performance produced when 5 V is used for the supply voltage. The inductance of the RF choke should be approximately 100 nH, and care should be taken to ensure that the lowest series self-resonant frequency of this choke is well above the maximum frequency of operation for the AD8353. For lower frequency operation, use a higher value inductor.

Bypass the supply voltage input, VPOS, using a large value capacitance (approximately 0.47  $\mu$ F or larger) and a smaller, high frequency bypass capacitor (approximately 100 pF) physically located close to the VPOS pin.

The recommended connections and components are shown in Figure 41.

## APPLICATIONS INFORMATION

The AD8353 RF gain block can be used as a general-purpose, fixed gain amplifier in a wide variety of applications, such as a driver for a transmitter power amplifier (see Figure 38). Its excellent reverse isolation also makes this amplifier suitable for use as a local oscillator buffer amplifier that would drive the local oscillator port of an upconverter or downconverter mixer (see Figure 39).

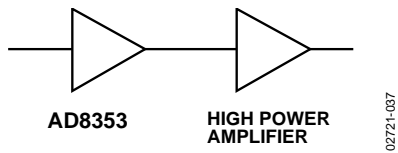

Figure 38. AD8353 as a Driver Amplifier

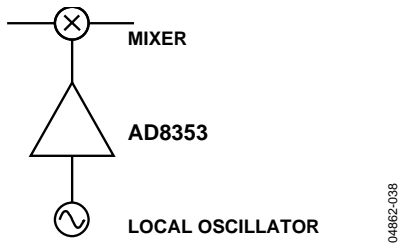

Figure 39. AD8353 as a LO Driver Amplifier

### LOW FREQUENCY APPLICATIONS BELOW 100 MHz

The AD8353 RF gain block can be used below 100 MHz. To accomplish this, the series dc blocking capacitors, C1 and C2, need to be changed to a higher value that is appropriate for the desired frequency. C1 and C2 were changed to 0.1  $\mu$ F to accomplish the sweep in Figure 40.

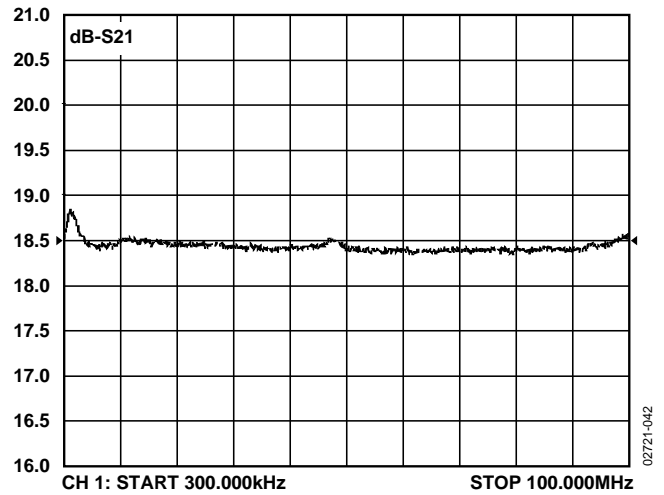

Figure 40. Low Frequency Application from 300 kHz to 100 MHz at 5 V VPOS, -12 dBm Input Power

### EVALUATION BOARD

Figure 41 shows the schematic of the AD8353 evaluation board. Note that L1 is shown as an optional component that is used to obtain maximum gain only when  $V_P = 3$  V. The board is powered by a single supply in the 2.7 V to 5.5 V range. The power supply is decoupled by a 0.47  $\mu$ F and a 100 pF capacitor.

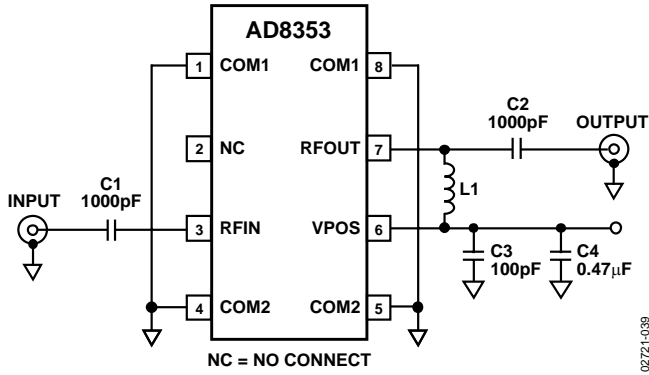

Figure 41. Evaluation Board Schematic

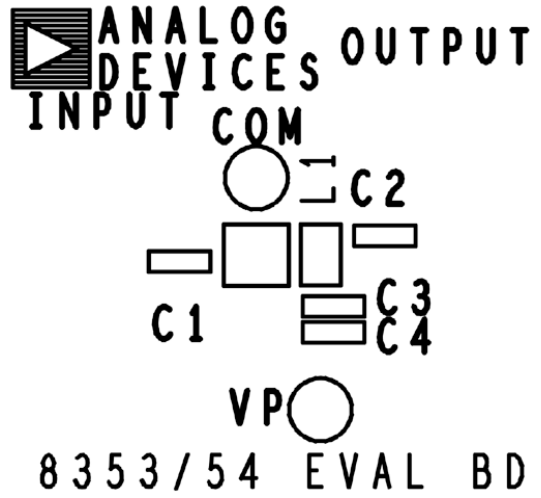

Figure 42. Silkscreen Top

Table 5. Evaluation Board Configuration Options

Component	Function	Default Value
C1, C2	AC coupling capacitors.	1000 pF, 0603
C3	High frequency bypass capacitor.	100 pF, 0603
C4	Low frequency bypass capacitor.	0.47 $\mu$ F, 0603
L1	Optional RF choke, used to increase current through output stage when $V_P = 3$ V. Not recommended for use when $V_P = 5$ V.	100 nH, 0603

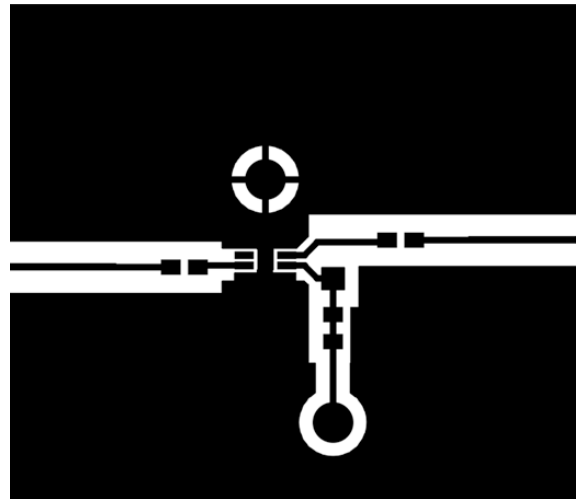

Figure 43. Component Side



OUTLINE DIMENSIONS

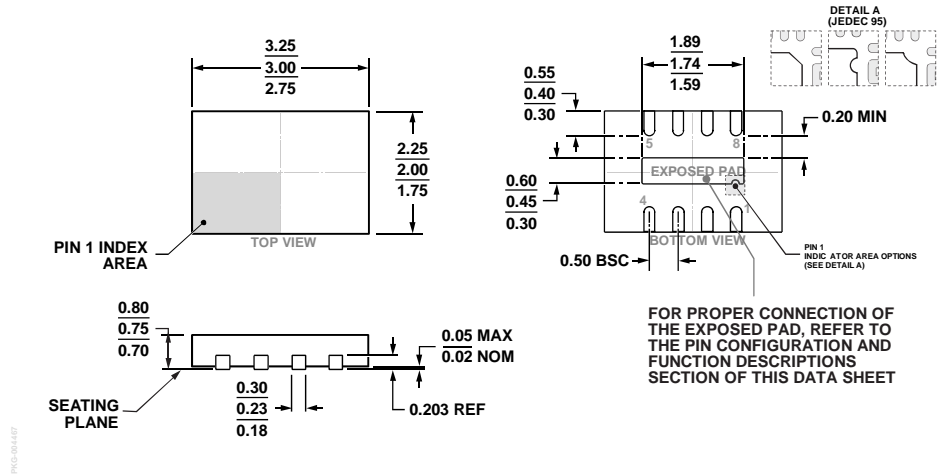

Figure 44. 8-Lead Lead Frame Chip Scale Package [LFCSP]  
 2 mm × 3 mm Body and 0.75 mm Package Height  
 (CP-8-23)  
 Dimensions shown in millimeters

ORDERING GUIDE

Model <sup>1</sup>	Temperature Range	Package Description	Package Option	Branding
AD8353ACPZ-REEL7	-40°C to +85°C	8-Lead Lead Frame Chip Scale Package [LFCSP], 7" Tape and Reel	CP-8-23	0E
AD8353-EVALZ		Evaluation Board		

<sup>1</sup> Z = RoHS Compliant Part.