

"Schutzvermerk nach DIN ISO 16016 beachten" "Please pay attention to copyright note DIN ISO 16016"

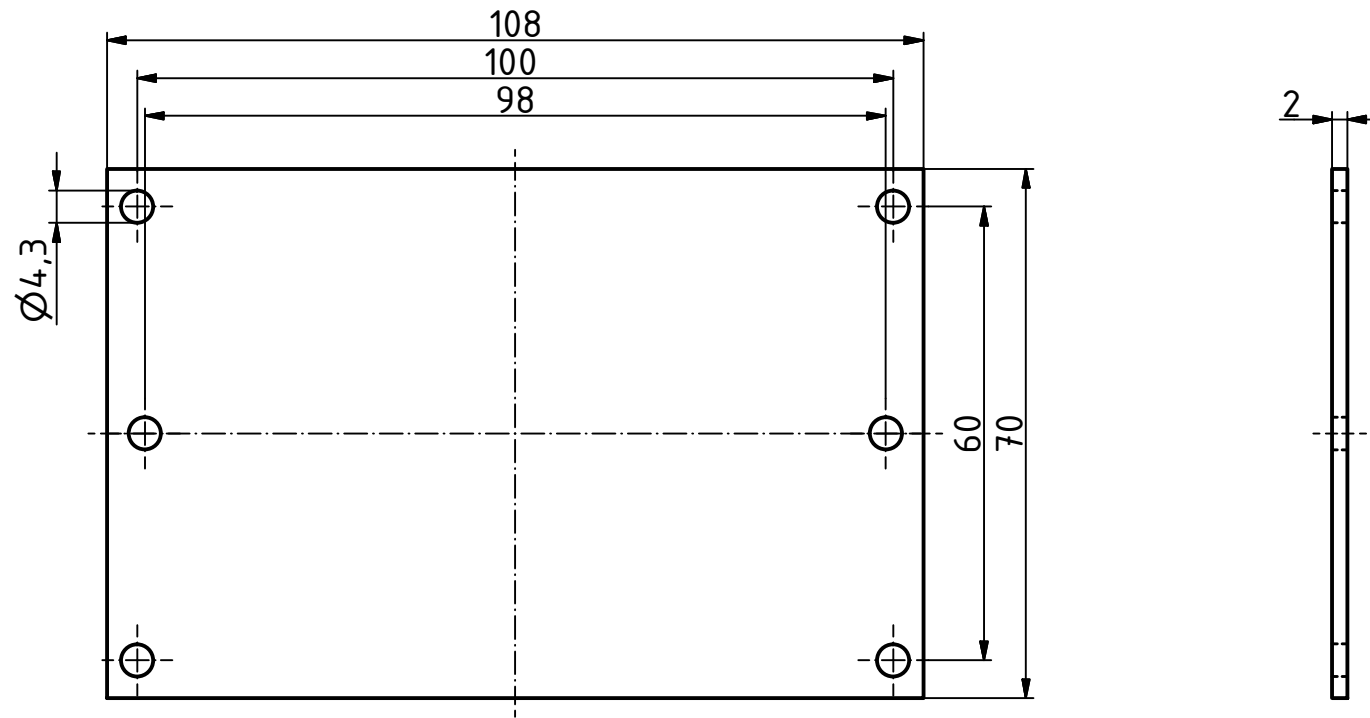

Maßstab/ Scale: 1:1

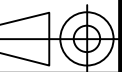

Zeichnungs-Nr. / Drawing-No.:
3K 5420.076.01

Artikel / Article:
Bocube Alu
BA MH 1408
Katalogzg./Catalogue draw.

Ä.Nr/
Alt.No:

Datum/
Date:



BOPLA

A Phoenix Mecano Company

DISK: 2403783.idw
Datum/Date: 02.06.2015 FW