

"Schutzvermerk nach DIN ISO 16016 beachten." "Please pay attention to copyright note DIN ISO 16016"

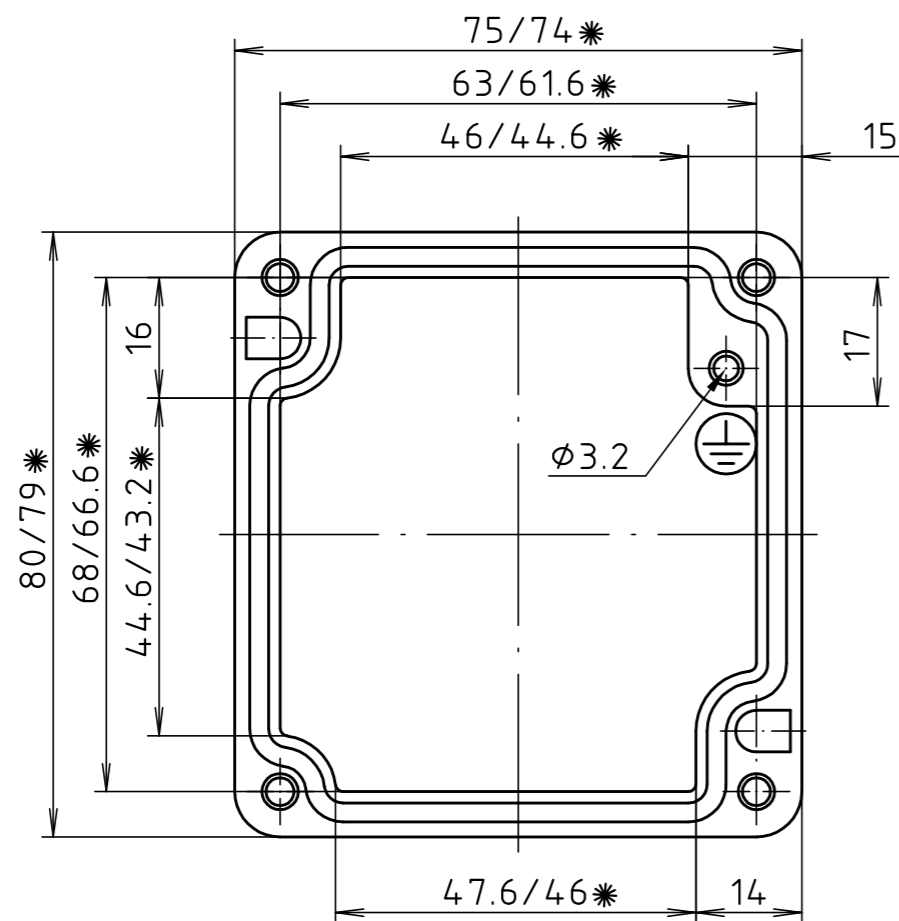

Deckel/lid

* = Mass durch Formkonizität nach unten verringert.
 Freimass – Toleranz nach GTA 13/5 DIN 1688/
 Dimension reduced at bottom due to conical form.
 Tolerances to GTA 13/5 DIN 1688

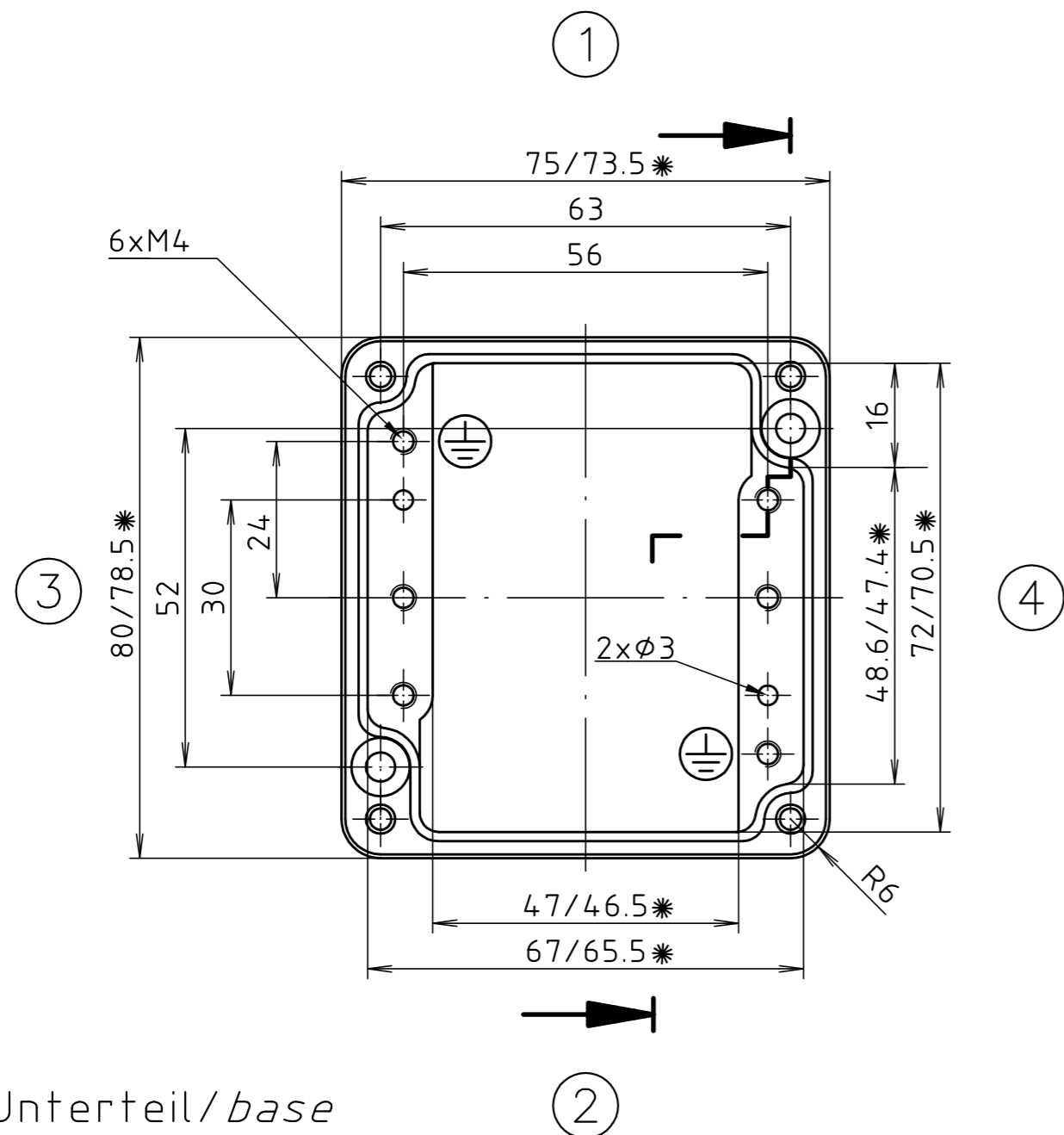

Unterteil/base

Zylinderschraube M4 x 20/7
 ähnl. DIN EN ISO 1207/
 cylinder screw M4 x 20/7
 similar to DIN EN ISO 1207

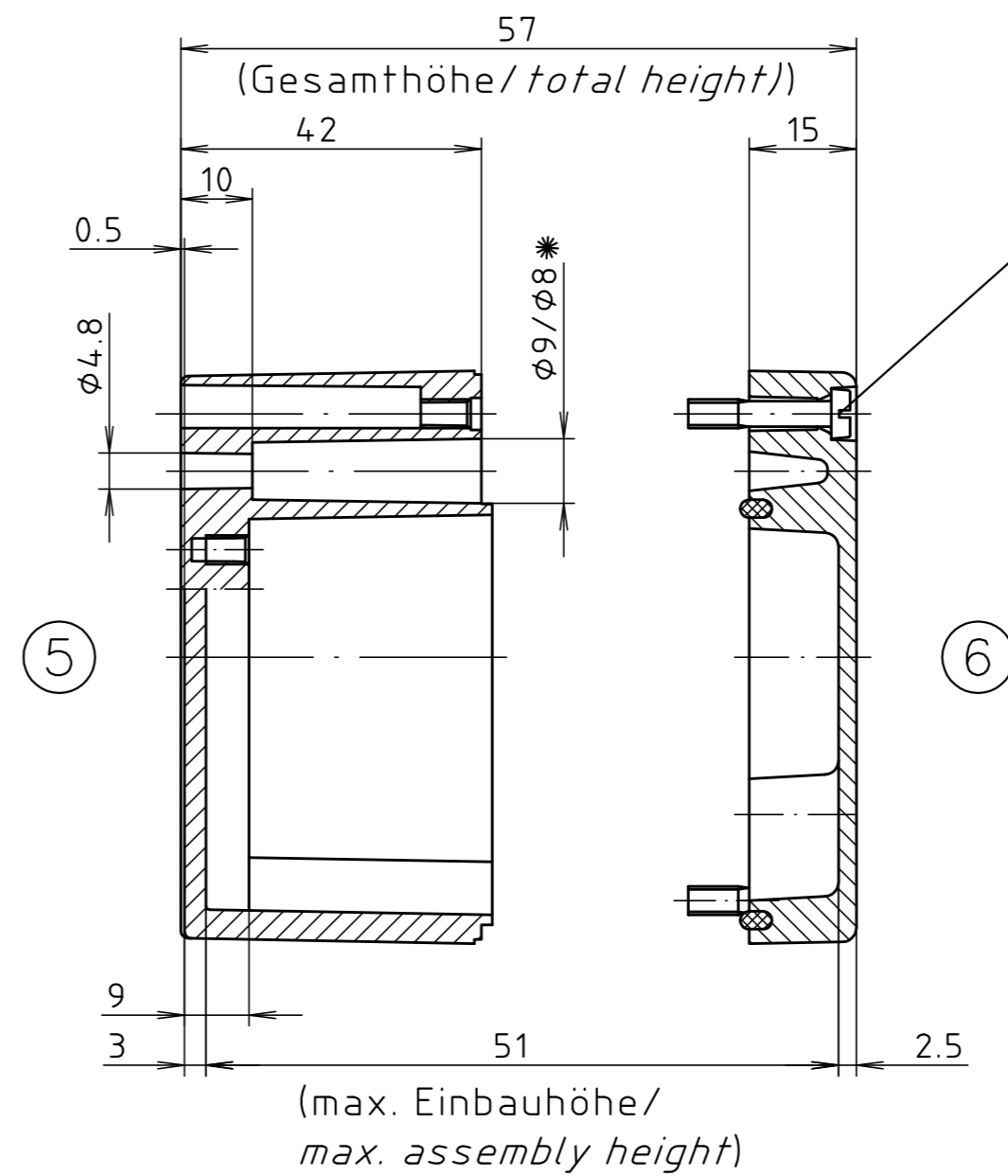

Maßstab/ Scale: 1:1		
Zeichnungs-Nr. / Drawing-No.: 2K 105.007.03		
Artikel / Article: A105 / 01.080806 Katalogzeichnung/ Catalogue drawing		
A.Nr./ Alt-No.:	Datum/ Date:	
DISK:	2 401 714	
Datum/Date: 27.04.99 HR		

