

Overview

Inductive sensor is a kind of proximity sensor.

Concept of Proximity Sensor

Proximity sensor is used to detect the proximity of objects and control the switch under the condition of non-contact by using the sensitive characteristics of sensors to close objects. In the common proximity sensor, according to the principle of induction, the proximity sensor can be divided into three types: high frequency oscillation, magnetic induction and electrostatic capacitance.

Features of Proximity Sensor

- ◆ No mechanical contact, low power Consumed and long life.
- ◆ Suitable for harsh working environment, reliable work.
- ◆ High repeatability of the detection, can accurately judge the location of the object.
- ◆ High response frequency, suitable for fast moving object detection.

Basic Principle of Inductive Sensor

High frequency alternating magnetic field is generated in the front-end detection coil. When the metal object is close to the magnetic field, eddy current is generated inside the metal object due to electromagnetic induction, leading to the attenuation of magnetic field energy, which is called eddy current loss. When the sensing surface of the proximity sensor is constantly close to the metal object, the attenuation of the magnetic field energy of the metal object is constantly increasing. When the attenuation reaches a certain degree, the sensor triggers the switch to output signals, so as to detect the presence or absence of the object.

Movement Differential

The difference between the induction distance when the proximity switch operates and the distance generated when the proximity switch is reset is the response distance. The response distance of the proximity switch is the response distance measured when the standard detection object is used.

Consumed Current

The current required in the working state of the sensor.

Leak Current

When the sensor is not turned on, the residual current in its load is called leak current.

Response Frequency

Response frequency is the maximum number of actions per second of the sensor.

Model Naming

Product Name:

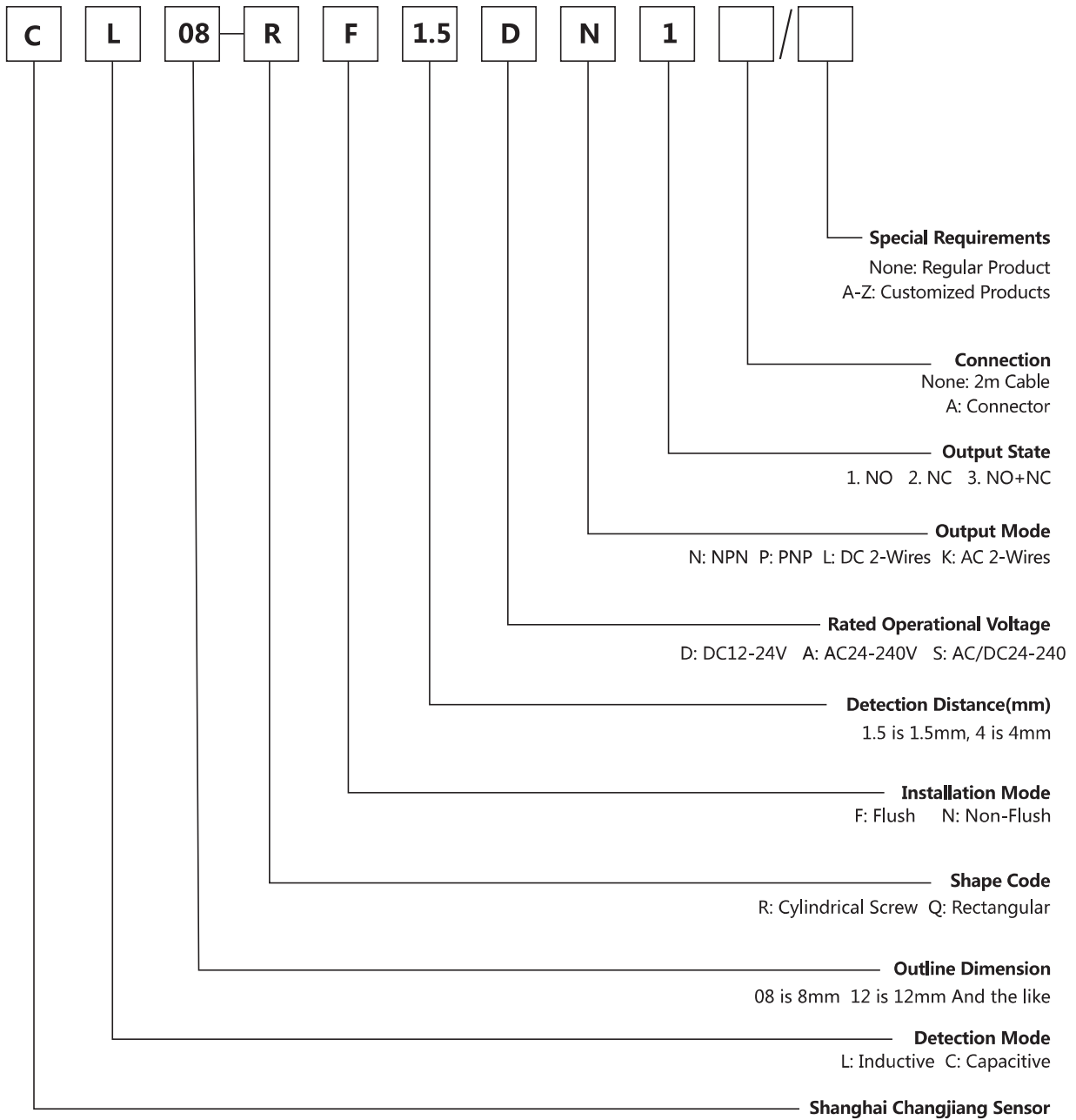

Inductive Sensor

Standard Function Type

- ◆ The non-contact detection method is safe and reliable.
- ◆ The special IC is used to design and manufacture to improve the anti-interference performance.
- ◆ Durable and high reliable, can replace small switches and limit switches.

Full Specification:

The cylindrical series M08 to M30mm and the rectangular series 17*17 to 40*40 mm.

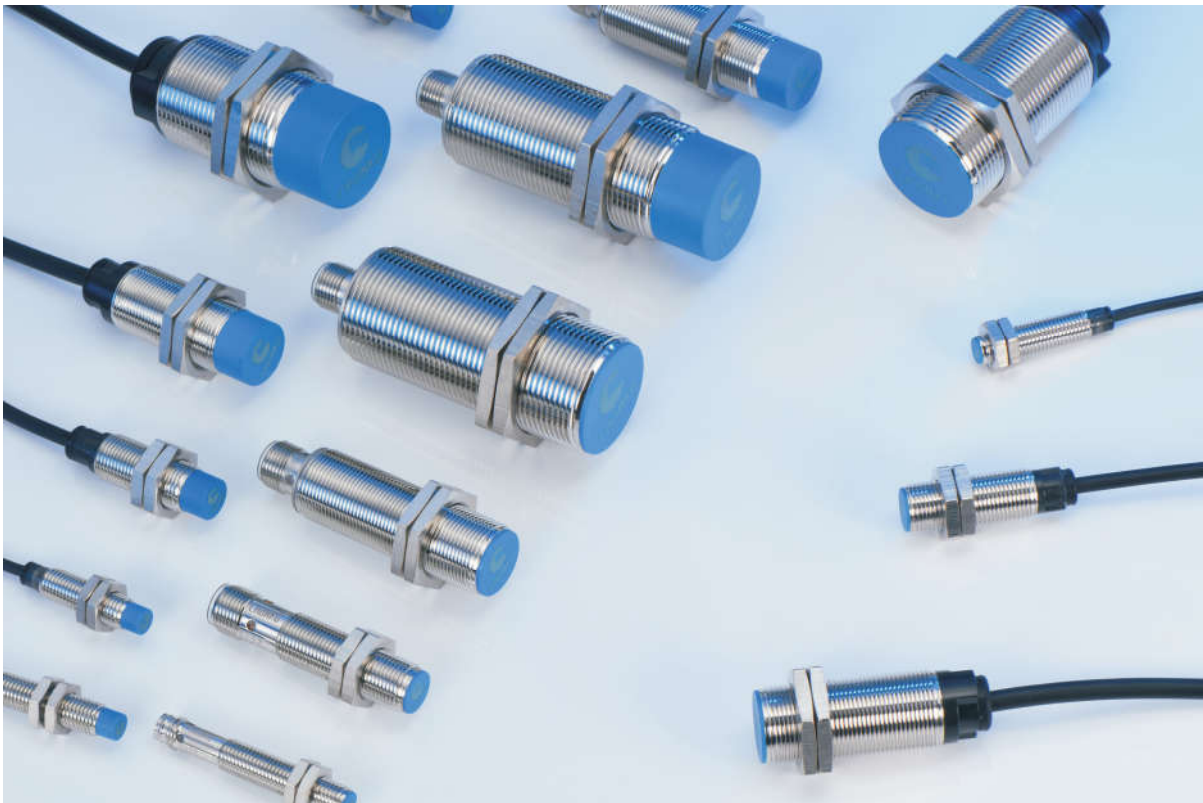

Inductive Sensor - Rectangular

- ◆ The measurement deviation between the same type of sensor is very small
- ◆ High temperature stability
- ◆ Strong anti-interference ability
- ◆ M standard cable
- ◆ IP67 grade
- ◆ Strong and durable structure, stable and reliable performance, good consistency, high cost performance



DC 3-Wires

Product No.		CL17	CL25	CL30	CL40
Installation Mode		Non-flush	Non-flush	Non-flush	Non-flush
Detection Distance		5mm±10%	5mm±10%	10mm±10%	20mm±10%
Setting Distance		0~4mm	0~4mm	0~8mm	0~16mm
Size (mm)		17*17*30	25*25*43	30*30*57	40*40*57
Output Mode	NPN NO	CL17-QN5DN1	CL25-QN5DN1	CL30-QN10DN1	CL40-QN20DN1
	NPN NC	CL17-QN5DN2	CL25-QN5DN2	CL30-QN10DN2	CL40-QN20DN2
Output Mode	PNP NO	CL17-QN5DP1	CL25-QN5DP1	CL30-QN10DP1	CL40-QN20DP1
	PNP NC	CL17-QN5DP2	CL25-QN5DP2	CL30-QN10DP2	CL40-QN20DP2
Technical Parameter					
Standard Detection Object		Iron 15×15×1mm	Iron 30×30×1mm	Iron 40×40×1mm	Iron 50×50×1mm
Response Frequency		500Hz	500Hz	500Hz	40Hz
Movement Differential		Less than 10% of detection distance			
Supply Voltage		DC12-24V ripple (p-p) less than 10% (DC10~30V)			
Service Voltage Range		Less than 8mA (at DC12V), less than 15mA (at DC24V)			
Consumed Current		Less than 100mA			
Control Output	Switching Capacity	Below 2V (load current 200mA)			
	Residual Voltage	Action display (red)			
Indicator		Reverse protection, surge absorption			
Protection Circuit		Working / Storing: -25~+70°C (no freeze, no dew)			
Ambient Temperature Range		Working / Storing: 35~95%RH (no dew)			
Ambient Humidity Range		Temperature range from -25 °C to +70 °C is +23 °C, the detection distance is less than ±10%.			
Temperature Effect		In the range of ±10% of the rated power supply voltage and ±2.5% of the rated power supply voltage, the detection distance is less than ±2.5%.			
Influence of Voltage		Above 50MΩ (DC500V megger) between the whole charging part and the shell			
Insulation Resistance		AC1, 000V 50/60Hz 1min between the whole charging part and the shell			
Withstand Voltage		10~55Hz up and down amplitude is 1.5mm, 2 hours in X、Y、Z directions			
Vibration (Durability)		300m/s ² 10 times in X、Y、Z directions			
Impact (Durability)		IEC Standard IP67			
IP Grade		2m PVC cable	2m PVC cable	2m PVC cable	2m PVC cable
Connection Mode		About 58g	About 99g	About 136g	About 198g
Weight		Case: heat resistant ABS, Standard Cable (Black) PVC			
Material					

Outline Size and Output Circuit Diagram

Rectangular Wire Outline Dimensions

CL17-QN5□□□-□/□

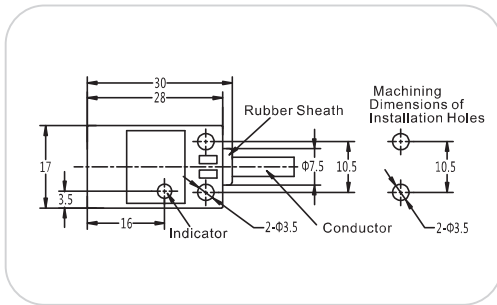

CL25-QN5□□□-□/□

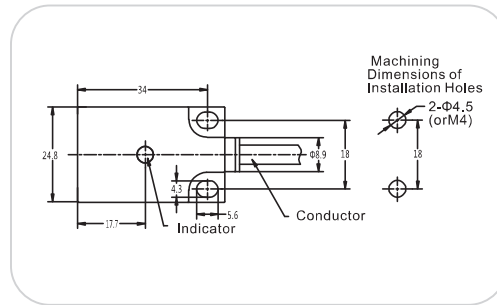

CL30-QN10□□□-□/□

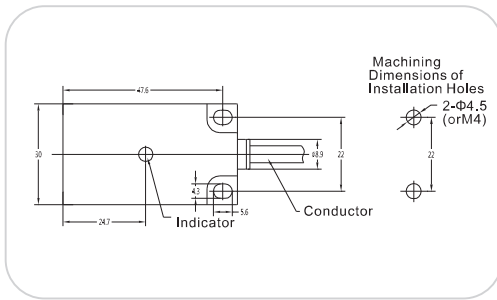

CL40-QN20□□□-□/□

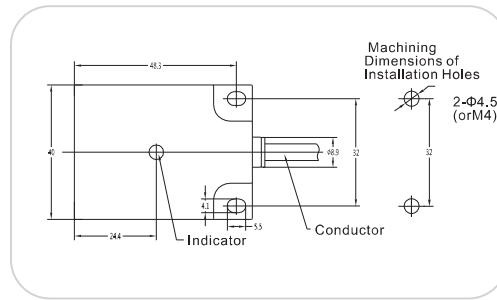

Output Circuit Diagram

CL□-QN□□□□-□/□

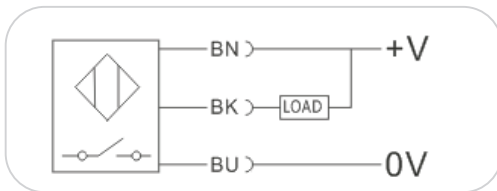

NPN Output

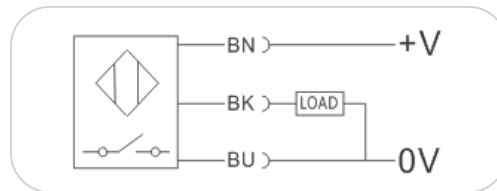

PNP Output

Product Installation Mode

Flush Installation of Inductive Sensor:

When the inductive sensor (proximity switch) detection surface and the metal surface are mounted flush, other surfaces are submerged in the metal surface and are not affected by the metal object. Please refer to

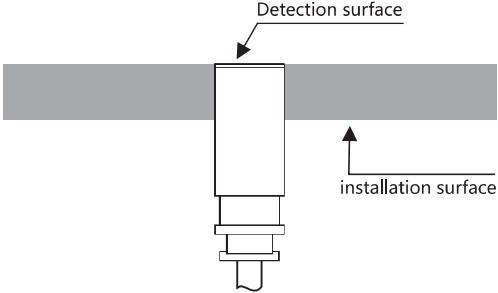

Non-Flush Installation of Inductive Sensor:

The non-embedded inductive sensor (proximity switch) cannot be submerged in the metal surface around the sensor surface, and it is easy to be affected by the metal surface. The detection distance of the non-submerged inductive sensor is longer, and the distance between the sides of the inductive sensor must be 3 times as long as that of the detection head during installation to prevent interference by metal objects.

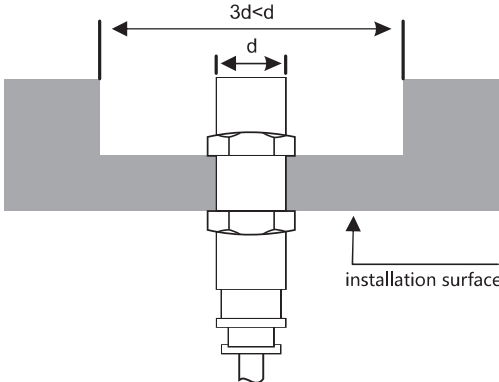

Side-by-Side Installation of Inductive Sensor

When multiple inductive sensors (proximity switches) are required to be installed side by side, in order to prevent interference between proximity switches, please refer to the chart less than to reserve a distance.

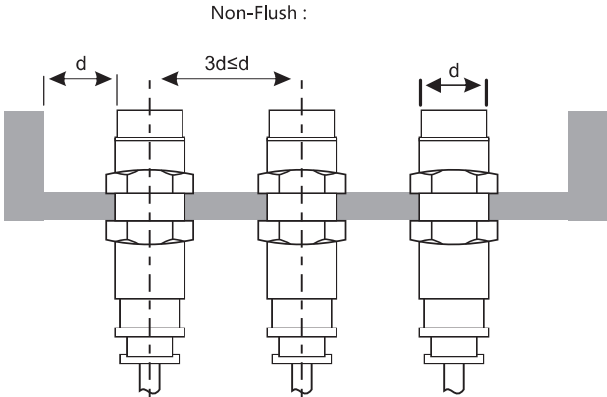
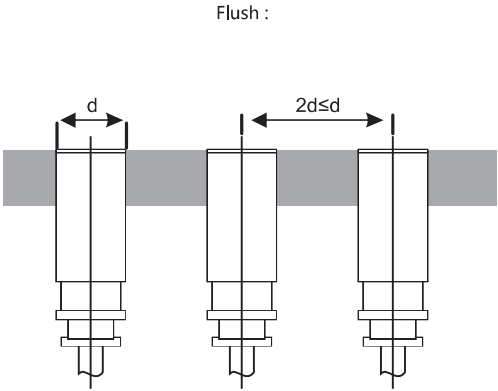

The effect of the material close to the detected object on the measuring distance

When detecting objects of different materials, the detection distance of the proximity switch has a corresponding change.

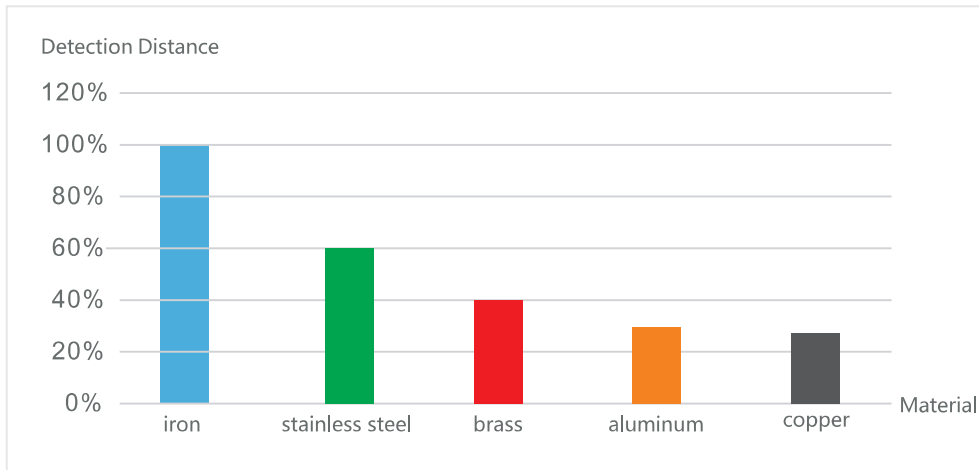

IP Grade Description

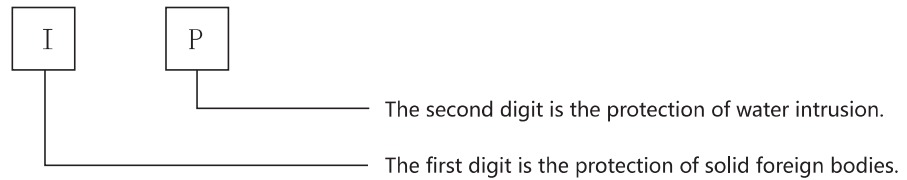

Jargon	Instruction			
IP67 Grade Standard		The first digit represents the level of protection (dust)	The second digit indicates the IP Grade	
	4	Prevent solid invasion of products with diameters greater than 1.0mm	4	Not affected by droplets splashing in any direction
	5	Prevent dust from operating site	5	Not affected by water injection in any direction
	6	Prevent all dust from invading	6	Not intruded by water spraying in any direction
			7	No effect on invasion of water under specified time and pressure
			8	Can still be used in water under specific pressure

Product Application Case

Our products are widely used in food packaging, transportation equipment, textile machinery, semiconductor, printing machinery, pharmaceutical machinery, logistics industry, medical devices, elevators and so on.

Detection of bottle caps



Manipulator application



Panel count

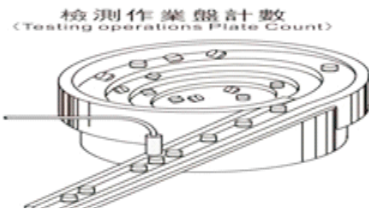

Test the product for changes

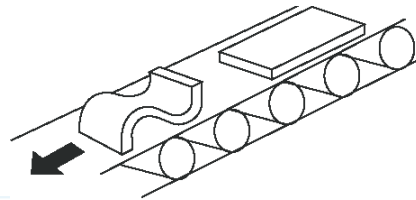

Mold positioning detection

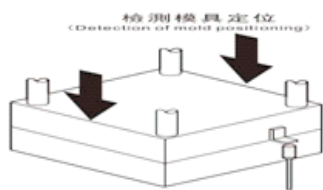

Test screw height

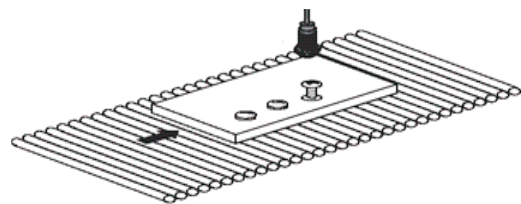

Location detection

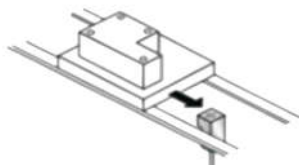

Equipment production line application

