

REV.	DESCRIPTION	DRAWN	CHECKED	APPROVED
A	NEW RELEASE	LJH 09/20/05'	~	LJC 09/20/05'
B	料号中增加尺寸DIM. H, E选项	YCH 07/18/08'	~	LJC 07/18/08'
C	ADD P/N CODE	YCH 12/02/13'	~	LJC 12/02/13'
F	DRAWING UPDATE	JLZ 07/21/16'	~	

NOTES:

1. ELECTRICAL CHARACTERISTICS:

- 1.1 CONTACT RESISTANCE: 20mΩ Max. INITIAL.
- 1.2 DIELECTRIC WITHSTANDING VOLTAGE: 500V AC(rms) FOR 1 MINUTE.
- 1.3 INSULATION RESISTANCE: 1000MΩ Min.
- 1.4 CURRENT RATING:3A.

2. ENVIRONMENT CHARACTERISTICS:

TEMPERATURE RANGE: -40°C~+105°C.

3. PRODUCT NUMBER CODE:

DS1013- X X X X X - X - X

HOUSING MATERIAL  
 0: PBT UL94 V-0  
 2: PBT UL94 HB  
 4: PA-46  
 9: PA-9T

PLATING LEVEL(FOR GOLD ONLY)  
 3A: LEVEL B: LEVEL B  
 N: LEVEL N

DIM. H TYPE (FOR ELEVATOR ONLY)  
 1: 7.50  
 2: 9.50

DIM. E TYPE (FOR V/T ONLY)  
 1: 3.10  
 2: 8.00

HOUSING COLOR  
 B: BLACK U: BLUE  
 W: WHITE A: GRAY

CONTACT PLATING  
 Si: FULL GOLD FLASH

MOUNTING TYPE  
 S: V/T TYPE  
 R: R/A TYPE  
 E: Elevator TYPE

No.OF CONTACTS  
 06 08 10 14 16 20 24  
 26 30 34 40 50 60 64

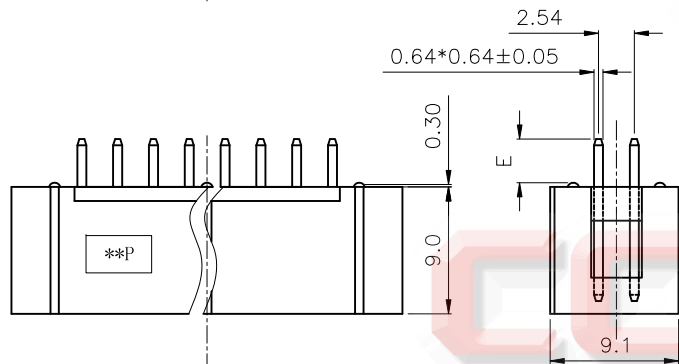
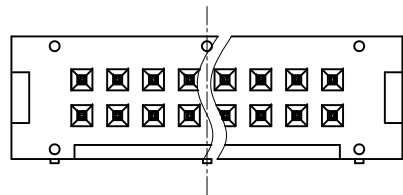

V/T TYPE

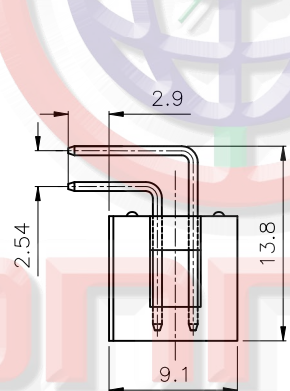

R/A TYPE

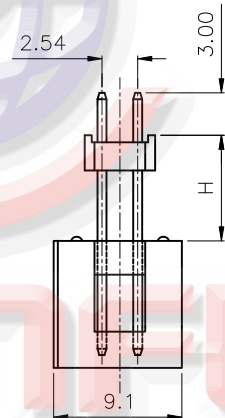

Elevator TYPE

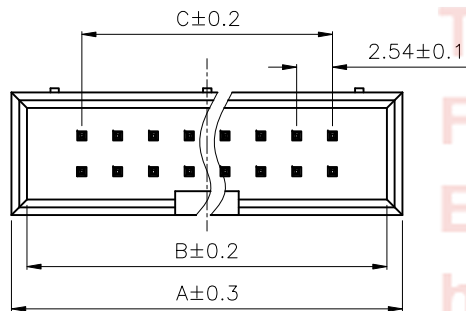

Dimension

Position	A	B	C				
06	15.22	13.02	5.08				
08	17.76	15.56	7.62				
10	20.30	18.10	10.16				
12	22.84	20.64	12.70	30	45.70	43.50	35.56
14	25.38	23.18	15.24	34	50.78	48.58	40.64
16	27.92	25.72	17.78	40	58.40	56.20	48.26
20	33.00	30.80	22.86	50	71.10	68.90	60.96
24	38.08	35.88	27.94	60	83.80	81.60	73.66
26	40.62	38.42	30.48	64	88.88	86.68	78.74

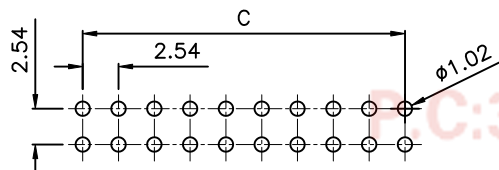

RECOMMEND PCB LAYOUT(TOLERANCE=±0.05)

GENERAL TOLERANCE		ANGLE TOLERANCE	
X.	±0.60	X.	±5°
.X	±0.38	.X	±3°
.XX	±0.25	.XX	±2°

DRAWING TYPE	CUSTOMER		
SCALE	1:1	SHEET	1 OF 1
DRAWING NO.	C-DS1013-XXXX-X-X-F		

PROJECTION	TITLE
mm	2.54mm BOX HEADER R/A, V/T & ELEVATOR TYPE
A4	SERIES DS1013 SERIES



CONNFLY®

晨翔电子有限公司

CONNFLY ELECTRONIC CO., LTD

REV.	DESCRIPTION	DRAWN	CHECKED	APPROVED
A	NEW RELEASE	LJH 09/20/05'	~	YCH 09/20/05'
B	ADD P/N CODE	YCH 12/02/13'	~	LJC 12/02/13'
C	DRAWING UPDATE	JLZ 11/09/17'	~	

NOTES:

- ELECTRICAL CHARACTERISTICS:
  - CONTACT RESISTANCE: 20mΩ Max. INITIAL.
  - DIELECTRIC WITHSTANDING VOLTAGE: 500V AC(rms) FOR 1 MINUTE.
  - INSULATION RESISTANCE: 1000MΩ Min.
  - CURRENT RATING:3A.
- ENVIRONMENT CHARACTERISTICS:
 

TEMPERATURE RANGE: -45°C~+105°C.
- PRODUCT NUMBER CODE:

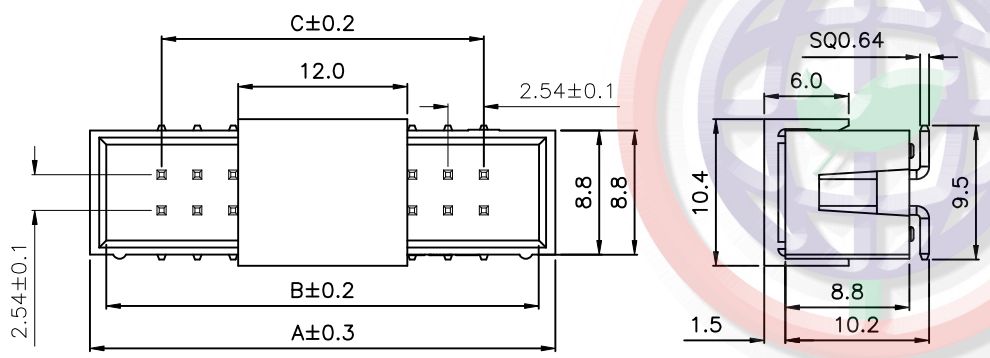
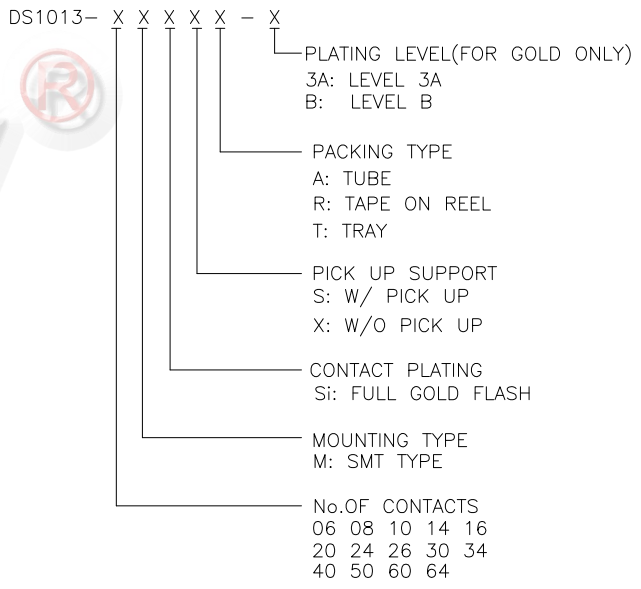

Dimension

Position	A	B	C
06	15.22	13.02	5.08
08	17.76	15.56	7.62
10	20.30	18.10	10.16
12	22.84	20.64	12.70
14	25.38	23.18	15.24
16	27.92	25.72	17.78
20	33.00	30.80	22.86
24	38.08	35.88	27.94
26	40.62	38.42	30.48
30	45.70	43.50	35.56
34	50.78	48.58	40.64
40	58.40	56.20	48.26
50	71.10	68.90	60.96
60	83.80	81.60	73.66
64	88.88	86.68	78.74

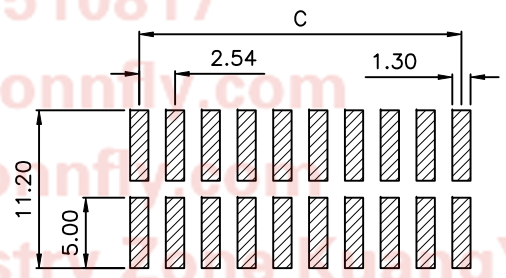
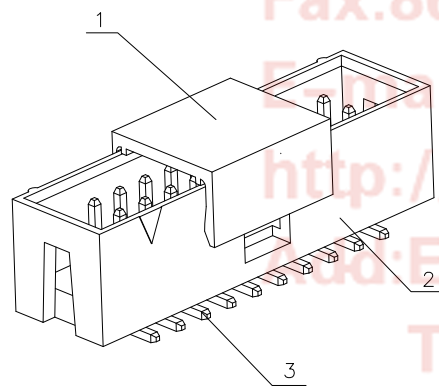
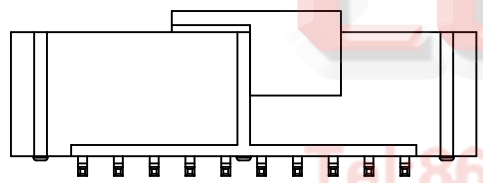

RECOMMEND PCB LAYOUT  
TOLERANCE=±0.05

GENERAL TOLERANCE		ANGLE TOLERANCE	
X.	±0.60	X.	±5°
.X	±0.38	.X	±3°
.XX	±0.25	.XX	±2°

PROJECTION		TITLE	2.54mm BOX HEADER
UNITS	mm		SMT TYPE
SHEET SIZE	A4	SERIES	DS1013 SERIES

ITEM	PART NAME	PART NO.	MATERILAS	FINISHED
3	CONTACT		COPPER ALLOY	GOLD FLASH
2	HOUSING		PA-9T	RoHS II & REACH,UL94 V-0
1	PICK UP		PA-9T	RoHS II & REACH,UL94 V-0

DRAWING TYPE	CUSTOMER
SCALE	1:1
SHEET	1 OF 1
DRAWING NO.	C-DS1013-XXMXXX-X-C

**晨翔电子有限公司**  
**CONNFLY® CONNFLY ELECTRONIC CO., LTD**