

The information provided herein is from CONNELY Electronic Co., Ltd. and is confidential. Any disclosure to a party other than the recipient is prohibited. The intellectual properties and its rights contained herein, including but not limited to, trademarks, patents, copyrights, trade secrets, and technical know-how, are owned exclusively by CONNELY or its affiliates. Unauthorized use of this information in any format or manner. CONNELY may enforce its intellectual property rights at its own discretion; failures or delays to exercise such rights does not constitute a waiver of such rights.

1 2 3 4 5 6 7 8

REV.	DESCRIPTION	DRAWN	CHECKED	APPROVED
A	NEW RELEASE	LJH 09/25/05'	~	LJC 09/25/05'
B	DRAWING UPDATE	LL 11/29/06'	~	LJC 11/29/06'
C	DRAWING UPDATE	JLZ 02/13/19'	~	

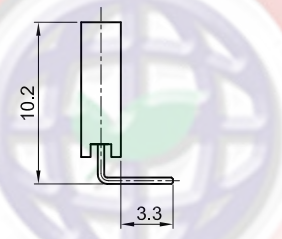
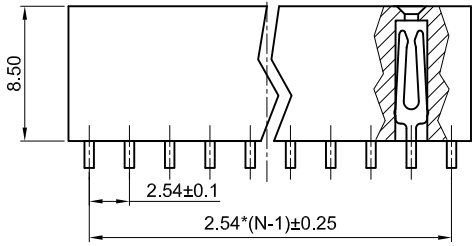
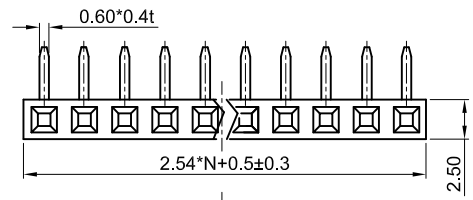

SINGLE ROW
N:NUMBER OF CONTACTS

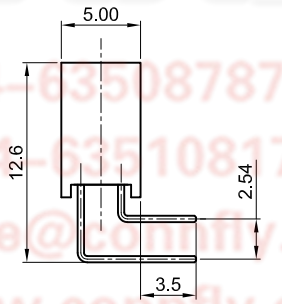
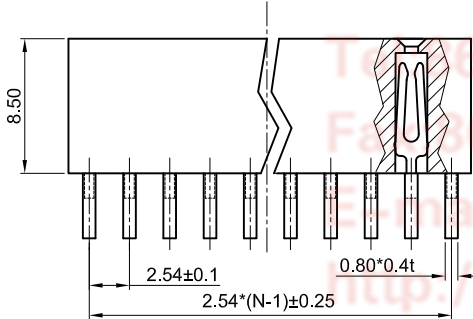
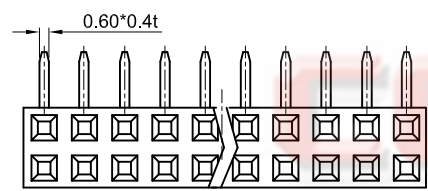

DOUBLE ROW
N:NUMBER OF CONTACTS/2

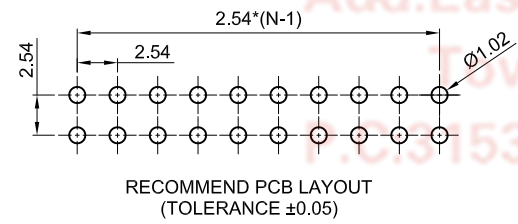

Notes:

Specifications:

- Contact Resistance: 20mΩ Max.
- Insulation Resistance: 1000MΩ Min.
- Dielectric Withstanding Voltage: 600V AC(rms) For 1 Minute.
- Current Rating:3A.
- Voltage Rating:250V AC rms.
- Temperature: -40°C~+105°C.

Materials:

- Contact Material: Copper Alloy.
- Contact Plating: Gold Plating Over Nickel.
- Insulator Materials: PBT,Black,UL94-V0.

Product Number Code:

DS1024- X X X

- CONTACT PLATING
F1: FULL GOLD FLASH
2: GOLD FLASH + NICKEL
- MOUNTING TYPE
R: R/A TYPE
- No.OF CONTACTS
1x2-1x40
2x2-2x40

GENERAL TOLERANCE		ANGLE TOLERANCE	
X.	±0.60	X.	±5°
.X	±0.38	.X	±3°
.XX	±0.25	.XX	±2°

DRAWING TYPE	CUSTOMER		
SCALE	1:1	SHEET	1 OF 1
DRAWING NO.	C-DS1024-XXX-C		

PROJECTION		TITLE	FEMALE HEADER PITCH 2.54MM R/A TYPE	
UNITS	mm			
SHEET SIZE	A4	SERIES	DS1024 SERIES	

晨翔电子有限公司
CONNFLY CONNELY ELECTRONIC CO. LTD

1 2 3 4 5 6 7 8