

REVISION RECORD			
REV	ECN	DESCRIPTION	DRFT DATE

8P and 8P following no reinforcement.

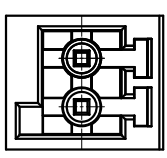
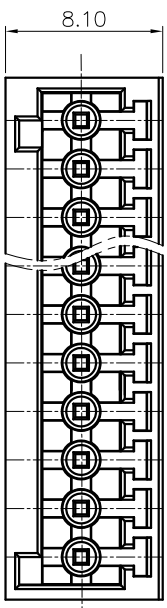
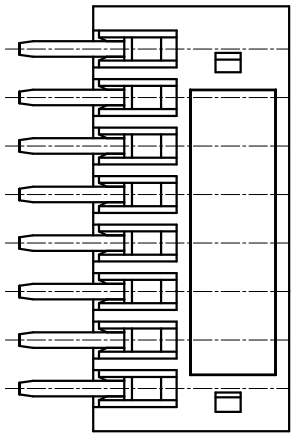

02P

- NOTES1:
 UL Standard
 1. Rated voltage/current : 150V / 4A
 2. Withstanding voltage : AC1500V/1Min.
 IEC Standard
 1. Pollution degree 2

Overvoltage category	II
Rate Impulse voltage(KV)	2.5KV
Rate voltage(V)	250V
Rate current(A)	5A

NOTES2:

- Dimension shall be interpreted per ASME Y14.5-2009
- Pitch : 2.5mm, Poles : N=02~12P
- Operating temperature: -40°C~+105°C
- Undimensioned tolerances:

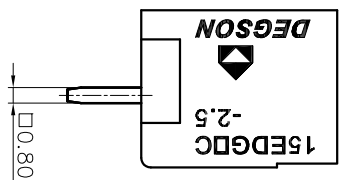
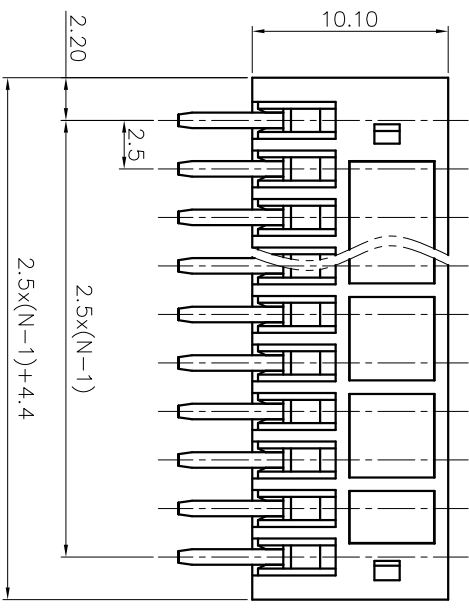
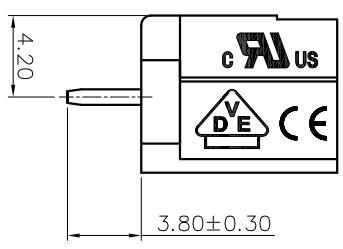

Pitch range in mm	Nominal dimension	range	mm	mm
Over	Over	Over	Over	Over
6	10	30	60	100
TO	TO	TO	TO	TO
10	24	30	100	150
6	10	60	100	150
±0.15/±0.20/±0.30/±0.30/±0.50/±0.70/±1.00/±1.30				
±2°				

5. RoHS Compliance

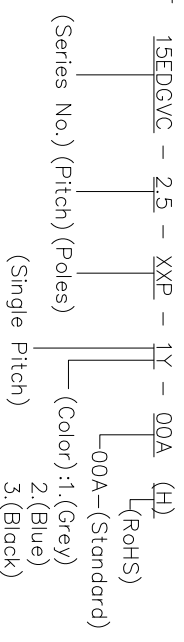

- (Blue)
- (Black)
- (Green)
- (Orange)
- (Red)
- (Transparent)
- (Yellow)
- (White)

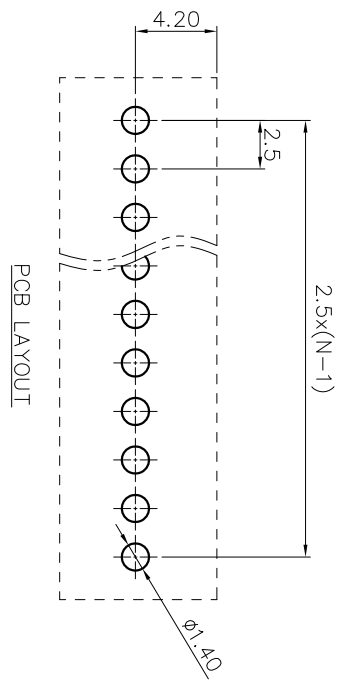

DETACHED LISTS	
PART NO.:	/
APPD:	/
CHKD:	/
DRFT:	/
THIRD ANGLE PROJECTION	
NAME:	DEGSON NINGBO DEGSON ELECTRICAL CO., LTD 宁波高松电子有限公司
TITLE:	CUSTOMER DRAWING
DRAWING NO.:	/
REV	DO
SHEET	1/1
SCALE	1:1