

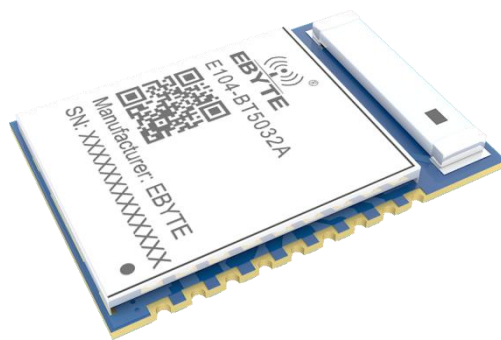

E104-BT5032A User Manual

nRF52832 BLE5.0 Low Power BLE to Serial Module



Contents

1. OVERVIEW	4
1.1 INTRODUCTION	4
1.2 FEATURES	4
1.3 APPLICATION	5
2. OPERATION NOTICE	5
2.1 BLE KNOWLEDGE	5
2.1.1 Connection interval, advertising interval and scanning interval	5
2.1.2 MTU	5
2.1.3 Distance response for data rate	6
2.1.4 Module advertises data in multi-connection	6
2.1.5 Flow control (CTS) and low power	6
2.1.6 The master data transmission rate is lower than the slave data transmission rate	6
2.1.7 Solution to abnormal power consumption caused by MOD pin in low power consumption mode	6
2.1.8 Solution to broadcast data problem	7
3. PARAMETER	7
3.1 LIMIT PARAMETER	7
3.2 OPERATING PARAMETER	7
4. DIMENSION AND PIN DEFINITION	9
5. RECOMMENDED CONNECTION DIAGRAM	11
6. FUNCTION	11
6.1 ROLES	11
6.1.1 Master	12
6.1.2 Slave	12
6.1.3 Observer	12
6.1.4 Master and slave as the one	13
6.2 POWER MODE	13
6.2.1 Low power mode	13
6.2.2 Wake up mode	13
6.3 DATA TRANSMISSION MODE	14
6.3.1 Transparent transmission	14
6.3.2 Format transmission	14
6.4 MAC ADDRESS BONDING	14
6.5 ADVERTISING	14
6.5.1 Normal advertising info.	14
6.5.2 iBeacon advertising info.	15
6.6 CONFIGURATION	15
6.7 DATA INDICATION	15
6.7.1 Output delay	16
6.8 UUID SPECIFICATION	16
6.9 GPIO FUNCTION	16
6.9.1 Input and output	17
6.9.2 PWM	17

6.10 MULTILINK	18
6.10.1 Connection handle	18
6.10.2 Obtaining a connection handle	18
7. AT COMMAND	18
7.1 COMMAND INSTRUCTION	18
7.2 ERROR CODE	18
7.3 STATUS PRINTING	19
7.4 COMMAND LIST	20
7.4.1 AT test command	20
7.4.2 AT+RESET Reset command	20
7.4.3 AT+RESTORE restore factory setting	20
7.4.4 AT+BAUD baud rate	20
7.4.5 AT+PARI parity	21
7.4.6 AT+HWFC flow control	21
7.4.7 AT+ROLE Bluetooth role	22
7.4.8 AT+DEVMANUF modify manufacture name	22
7.4.9 AT+DEVSERIAL modify device serial	22
7.4.10 AT+DEVMODEL modify device model	23
7.4.11 AT+DEVHWER modify hardware version	23
7.4.12 AT+DEVSVER modify software version	23
7.4.13 AT+DEVID modify device ID	24
7.4.14 AT+ADV enable advertising	24
7.4.15 AT+ADV DAT advertising data	24
7.4.16 AT+ADVINTV advertising gap	25
7.4.17 AT+IBCNUUID iBeacon UUID command	25
7.4.18 AT+MAJOR iBeacon Major Command	25
7.4.19 AT+MINOR iBeacon Minor command	26
7.4.20 AT+IPWR modify ibeacon tx_power	26
7.4.21 AT+NAME advertise device name	26
7.4.22 AT+CONPARAMS connection gap configuration	26
7.4.23 AT+CONPARAMSx specified connection interval setting	27
7.4.24 AT+DISCON disconnect command	28
7.4.25 AT+DATDLY Data output delay	28
7.4.26 AT+MAC local MAC address	29
7.4.27 AT+PEERMAC connect to device MAC	29
7.4.28 AT+BOND enable bonding	29
7.4.29 AT+BOND MAC add more bond MAC address	30
7.4.30 AT+BONDDEL delete bond MAC address	30
7.4.31 AT+SCAN advertising scan	30
7.4.32 AT+SCANINTV scan interval	31
7.4.33 AT+SCANWND scan window	31
7.4.34 AT+AUTOCONN connect automatically	31
7.4.35 AT+CONN specify connection	32
7.4.36 AT+LINKNUM query link	32

7.4.37 AT+TRANMD master transmission mode	32
7.4.38 AT+LINKMAX Master max link quantity	32
7.4.39 AT+LINKSLAVE Slave max link quantity	33
7.4.40 AT+UUIIDSVR128 set 128-bit UUID	33
7.4.41 AT+UUIIDSVR Bluetooth service UUID	34
7.4.42 AT+UUIIDCHARA1 SLAVE CHANNEL characteristic UUID	34
7.4.43 AT+UUIIDCHARA2 MAST CHANNEL characteristic UUID command	34
7.4.44 AT+VER query software version No.	34
7.4.45 AT+AUTH set authentication password over air	35
7.4.46 AT+UPAUTH change authentication password over air	35
7.4.47 AT+PWR transmitting power	35
7.4.48 AT+ONSLEEP sleep once power on	36
7.4.49 AT+DISCSLEEP disconnect and get into sleep	36
7.4.50 AT+SLEEP get into sleep mode immediately	36
7.4.51 AT+LOGMSG operating condition output	36
7.4.52 AT+PINCONF IO configuration	37
7.4.53 AT+PINSET Set IO high and low level	37
7.4.54 AT+PINGET Obtain IO high and low level	38
7.4.55 AT+PWMCONF PWM configuration	38
7.4.56 AT+PWMUNINIT Turn off PWM function	38
7.4.57 AT+PWMDUTYSET Change PWM cycle duty	39
7.4.58 AT+FILTER Device master filtering conditions	39
8. QUICK START	40
8.1 GUIDANCE FOR CONFIGURATION MODE	40
8.1.1 UART configuration	40
8.1.2 Configuration over air	40
8.2 DATA TRANSMISSION	42
8.2.1 Data transparent transmission	42
8.2.2 Format transmission	43
9. HARDWARE DESIGN	45
10. FAQ	46
10.1 COMMUNICATION RANGE IS TOO SHORT	46
10.2 MODULE IS EASY TO DAMAGE	46
10.3 BIT ERROR RATE IS TOO HIGH	46
11. PRODUCTION GUIDANCE	47
11.1 REFLOW SOLDERING TEMPERATURE	47
11.2 REFLOW SOLDERING CURVE	47
12. RELATED PRODUCT	48
13. PACKAGE FOR BULK ORDER	49
REVERSION HISTORY	50
ABOUT US	50

1. Overview

1.1 Introduction

Small in size and low in power consumption, E104-BT5032A is a serial-to-BLE module based on BLE 5.0 working at 2.4Ghz. It works as both Bluetooth master and slave.

Based on nRF52832 from Nordic, the E104-BT5032A module is developed by Chengdu Ebyte. AT commands are available for parameter setting, thus operation is simple and fast. There are Bluetooth master, slave and observer modes. It functionally supports low-power broadcast, data transparent transmission, and air configuration. It is widely used in smart wear, home automation, home security, personal health care, smart home appliances, accessories and remote control, automotive, lighting, industrial Internet, intelligent data acquisition, intelligent control, etc. The maximum continuous transmission baud rate is 921600bps.

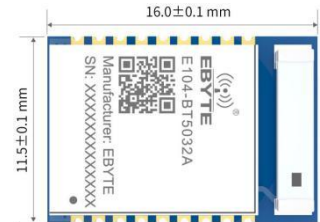

1.2 Features

- BLE 5.0;
- Working mode: configuration and transparent transmission mode;
- Automatic advertising and connection after power on;
- Switch between IBeacon and common broadcast available;
- Serial wake up available;
- MAC bonding connection;
- Serial transparent transmission and format transmission;
- Various serial modes and baud rates;
- Self-defined 16-bit UUID and 128-bit UUID;
- PCB antenna;
- Bluetooth parameter configuration over air is available;
- Distance : 70m (@4dBm、2Mbps) ;
- Ultra-low power sleep, synchronous broadcast;
- MAC address binding available. The maximum binding data is 8 devices(either master or slave);
- There are two connection modes: manual connection, automatic connection;
- Multiple masters and multiple slaves, up to 4 slaves can be connected;
- Dynamic modification of transmit power is available. The maximum power is 4dBm;
- Sniffing function available;
- MTU maximum is 247 bytes;
- Air data rate 2M,1M available;
- Max 8 channel GPIO input/output;
- Max 3 channel PWM output.

1.3 Application

- Smart home and industrial sensors;
- Security system, positioning system;
- Building automation solutions;
- Wireless remote control, UAV;
- Wireless game remote control;
- Healthcare sensor;
- Wireless voice, wireless headphones;
- RFID;
- Automotive applications.

2. Operation Notice

2.1 BLE knowledge

This chapter mainly focus on BLE knowledge.

2.1.1 Connection interval, advertising interval and scanning interval

In order to ensure low power consumption, BLE adopts interval working mode.

The scanning interval is to scan the advertising channel every certain time. The smaller the scanning interval, the higher the average power consumption during scanning, but the faster the slave device is found.

The advertising interval is that the advertising is released every certain time. The smaller the interval, the easier the slave device will be found by the master, and the higher the average power consumption.

For a connected BLE device, the master initiates a request to the slave every certain time (connection interval), and after receiving the request, the slave responds to the request of the master at the same time (connection interval). If the slave does not respond to the master request within the specified time (connection timeout), the master judges the slave to disconnect, while the slave fails to receive the request of the master within the prescribed time (connection timeout), and the slave judges that the master is disconnected connection. In order to reduce BLE power consumption again, the BLE protocol also stipulates that the slave can ignore requests for a specified number of times (slave timeout). The smaller the connection interval, the greater the data throughput, but the greater the power consumption. When users are concerned about data throughput, the connection gap can be reduced. Note that with regard to the connection interval, the connection interval between different devices may be different and cannot even be changed, such as the iPhone.

2.1.2 MTU

Refer to the effective size of the BLE air single packet data. The MTU in the ble 4.0 / 4.1 protocol is 27 bytes, which can be expanded from ble 4.2 and higher to 251 bytes.

When the MTU is actually used, the user's effective load is reduced by a 3-byte header. This means that the single packet data for 4.0 / 4.1 users is up to 24 bytes, and the single packet data for ble4.2 and later versions is up to 247 bytes.

In actual applications, the MTU value of different devices will be different. For example, the iPhone's MTU is 185 bytes, and users cannot change it.

2.1.3 Distance response for data rate

With ceramic antenna, compared with PCB antenna, ble signal on external antenna has poor TX and RX ability. The longer the distance, the slower the data rate.

2.1.4 Module advertises data in multi-connection

The module supports multiple connections. In multi-connection advertising, the module sacrifice communication speed in order to ensure data reliability. Multi-connection advertising rate is the lowest rate among multiple connections.

2.1.5 Flow control (CTS) and low power

If the module serial port is configured for flow control mode and CTS is disabled (CTS pin is high), the module cannot enter the low power consumption mode. As a solution, after CTS is asserted (CTS pin is low), low power consumption is entered through pins or instructions.

2.1.6 The master data transmission rate is lower than the slave data transmission rate

The slave sends data using the notification method to send data, the data sending rate is fast, while the master sends data using the write response method, the data sending rate is slow.

2.1.7 Solution to abnormal power consumption caused by MOD pin in low power consumption mode

This method is only for versions below V1.3, excluding V1.3.

Module switching method.

Set the MOD pin only before the data is sent. No operation after the data is sent.

For example:

a) Send AT command.

STEP1, set the pin to low level;

STEP2, send AT command;

STEP3, complete the data transmission.

b) Send data

STEP1, set the pin to high level;

STEP2, send data through UART;

STEP3, data transmission is completed.

2.1.8 Solution to broadcast data problem

This method is only for versions below V1.3, excluding V1.3.

Problem description: For versions below V1.3, if the user sets the broadcast data to {0x01,0x02,0x03,0x04}, the actual scan result is {0x02,0x01,0x03,0x04}

At present, it is compatible with the broadcast data of other models of BLE, which will be modified to {0x01,0x02,0x03,0x04} in V1.3.

It is recommended that users deal with this issue according to the firmware version.

3. Parameter

3.1 Limit parameter

Main parameter	Performance		Note
	Min	Max	
Voltage supply [V]	0	3.6	Voltage over 3.6V will cause permanent damage to module
Blocking power [dBm]	-	10	Chances of burn is slim when modules are used in short distance
Operating temperature [°C]	-40	+85	-

3.2 Operating parameter

Main parameter		Performance			Remarks
		Min	Typ	Max	
Voltage supply [V]		1.7	3.3	3.6	≥ 3.3 V ensures output power
Communication level [V]			3.3		For 5V TTL, it may be at risk of burning down
Operating temperature [°C]		-40	-	+85	
Frequency [MHz]		2402	-	2480	ISM band
Power consumption	Transmitting current (mA)	-	13	19	-
	Receiving current (mA)	-	13	-	-
	Stand-by current (μ A)	-	8	-	-
Transmitting power [dBm]		-	3.8	4	-
Receiving sensitivity [dBm]		-	-96	-	Bluetooth@lowenergymode

Random I/O	VIL/VIH	GND/0.84	GND/VCC	0.36/VCC
	VOL/VOH	GND/1.88	GND/VCC	0.47/VCC
Sleep advertising current(default)	-	173	-	unit: uA, default advertising gap is 1s
Wake-up advertising current(default)	-	8.70	-	unit: mA, default advertising gap is 1s
Wake-up no advertising current(default)	-	8.68	-	unit: mA, default connection gap is 500ms
wake-up connection current(default)	-	8.78	-	unit: mA

Main parameter	Description	Remarks
Distance	70m	Test condition: clear and open area, antenna gain: 5dBi, @4dBm, antenna height: 2m
BLE protocol	BLE 5.0	-
Communication interface	UART	-
Package	SMD	-
Connector	1.27 mm	-
Size	11.6*16mm	-
Antenna	Ceramic antenna	50Ω Impedance

4. Dimension and Pin Definition

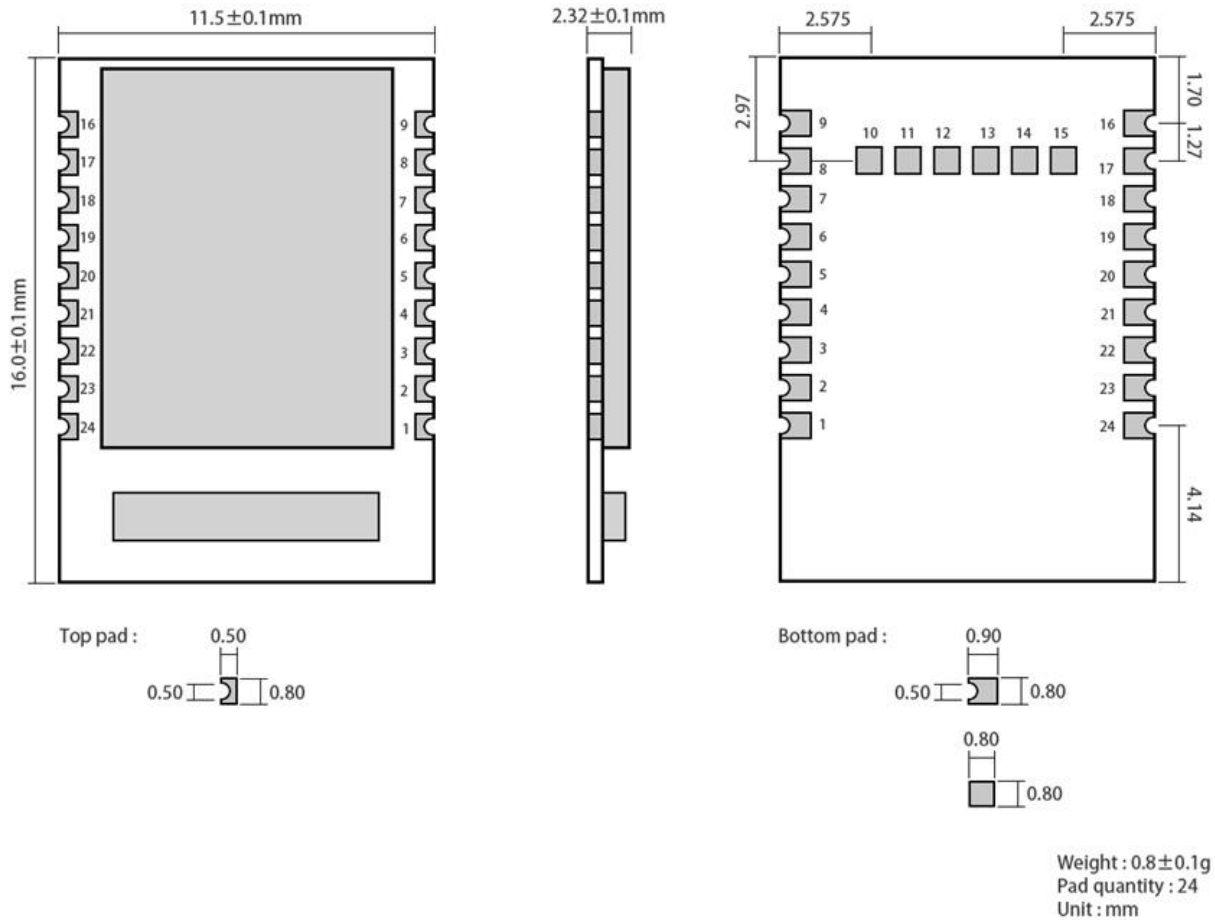

No.	Item	Direction	Application	Remarks
1	GND	Input	Ground	-
2	P0.25	-	NC	-
3	P0.26	-	NC	-
4	MOD ¹	Input	Mode selection	Low level: configuration mode; High level: transparent mode
5	WKP ²	Input	Wake up pin	Wake up: falling edge; Sleep: rising edge.
6	DISC	Input	Connection pin	Internal pull up. Valid in

¹ The internal level of the pin is self-latching. Ground directly or connect to the power supply when driving externally. When it is driven by external MCU, use the push output control.

² Same to 1.

			disconnected	falling edge
7	LINK ³	Output	Link status	Ble link: low level No ble link: high level
8	DATA ⁴	Output	Data indicator	Data indication pin, When the module outputs data through the serial port, the module sets the data pin to low level, indicating that data is being sent. The at instruction response does not change the state of the data pin.
9	GND	-	Ground	-
10	P0.02	-	NC	-
11	P0.03	-	NC	-
12	P0.04	-	NC	-
13	P0.05	-	NC	-
14	P0.06	-	NC	-
15	P0.07	-	NC	-
16	GND	-	Ground	Ground
17	VCC	-	Power	Power
18	RXD	Input	UART RX pin	-
19	TXD	Output	UART TX pin	-
20	RTS	Output	Flow control	Internal pull up
21	CTS	Input	Flow control	Internal pull up
22	P0.21/RST	-	Power reset	Valid in low level
23	SWDCLK	-	-	-
24	SWDIO	-	-	-

³ The internal level of the pin is self-latching. It internally pulls up for high level and pulls down for low level.

⁴ Same to 3.

5. Recommended connection diagram

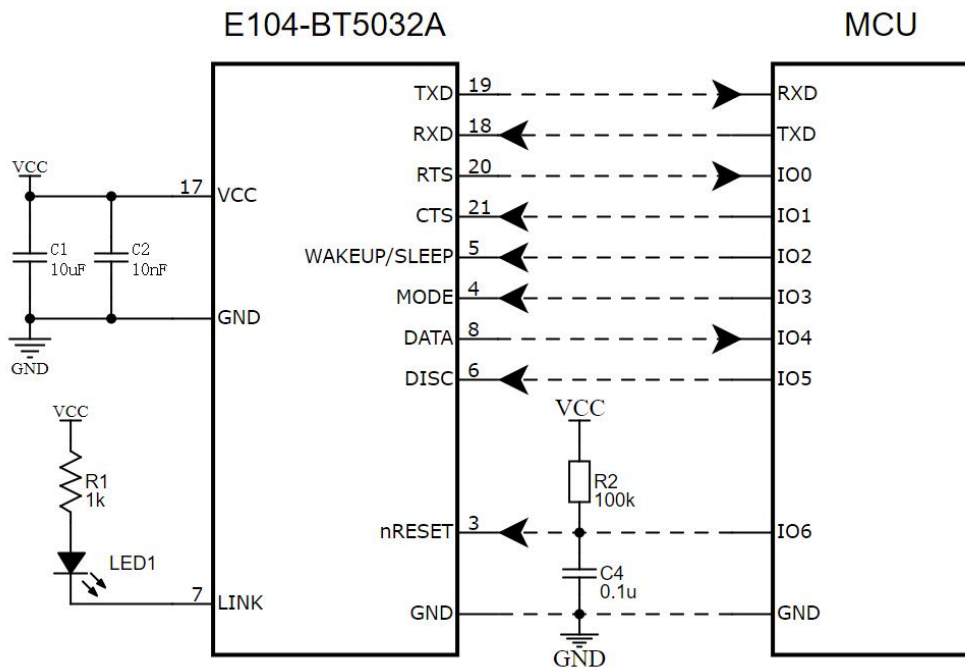

Note: The sensor refers to connecting an external device to a pin with an input function, the peripheral device refers to connecting an external device to a pin with an output function, and the MODE and WAKEUP / SLEEP pins refer to The two control pins are connected to the corresponding level state. If the module needs to be woken up, the WAKEUP / SLEEP (WKP) pin should be connected to a low level, or a falling edge signal should be given to the pin in time. If you need to switch between AT configuration mode and transparent transmission mode, you need to give the corresponding edge of the MODE (MOD) pin.

6. Function

6.1 Roles

There are four roles: master, slave, observer, salve and master as one.

The master module/slave and master as one connects to other Ebyte Bluetooth models. Up to 4 slaves can be connected to it. Transparent advertising and format transmission are available. Both manual and automatic connection are allowed.

The slave module connects to other Ebyte Bluetooth models, only one connection is allowed. Only transparent transmission is available for slave.

The observer is only used to print information about the ble device around the module and cannot be connected.

Note: BLE is initiated by the master, and the slave responds. Where it is located manually, the automatic connection function is only valid for the master and master-slave integration.

6.1.1 Master

1. AT+ROLE=1 choose role as master; Restart to take effect;
2. AT+SCAN=1 master scanning started;
3. AT+AUTOCONN configure if it is automatically connected after power on;
4. Once in manual connection, AT+CONN configure to connect specific device;
5. One master and multiple slave connection is available. Maximum connected slave quantity is 4;
6. Print status information when the master connection status changes. See 6.3 for Status Print.

6.1.1.1 Master connecting method

6.1.1.1.1 Condition filtering

The device can be configured to filter by MAC address bonding and service UUID.

UUID filtering [AT+UUIDSVR](#) is filtered according to the content configured by AT+UUIDSVR. The filtering condition cannot be closed. If MAC address filtering is not enabled, the MAC matches, it is automatically connected to the slave once service UUID is matched.

If the user needs MAC address filtering, MAC address filtering needs to be enabled through AT+BOND=1, and the MAC address is added to the master through AT+BONDMAC. After the master scans to the slave, if it is the same as the binding list MAC address and the service UUID, it automatically connects to the slave device.

If the master is configured as a manual connection, MAC address binding filtering will be ignored, but svruuid is consistent.

6.1.1.1.2 Automatic connection

If configured to connect automatically, the slave is automatically connected after the condition filter is met.

If configured to connect manually, turn on scanning. The master will scan the device with the service UUID matched and output through the UART (the data format is as shown in Figure below, the master outputs the scan result data format). The user connects to the specified slave device using AT+CONN.

RSSI(Signal quality)	MAC
1byte	6byte

6.1.2 Slave

1. AT+ROLE=0 choose role as slave. Restart to take effect.
2. AT+ADV=1 configure normal advertising mode.
3. The broadcast switch is configured to be enabled. Once power on, it automatically enters the broadcast state. Otherwise, the broadcast device cannot be found.
4. After receiving the master connection request, establish a Bluetooth connection to stop the Bluetooth broadcast and enter the data transparent transmission mode.
5. Check 5.5 for advertising configuration.

6.1.3 Observer

1. AT+ROLE=2 choose role as observer (Reset to be valid) .
2. After receiving the broadcast, print out the entire contents of the broadcast package through the serial port.
3. It cannot connect any device.

Format:

LEN	MAC	RSSI	Advdata
1 byte	6 bytes	1 byte	Within 31 bytes

Notes: LEN is sum of MAC, RSSI and advertising data length.

4. Scanning window, gap and parameter should be the same.
5. AT command is valid during this time.

6.1.4 Master and slave as the one

1. Command AT+ROLE=3, select master and slave as the one. Take into effect once restart.
2. Master function configuration is same as master from 6.1.1.
3. Slave function is same as slave from 6.1.2. This role supports multiple slaves.

6.2 Power mode

There are two modes: low power mode and wake-up mode.

6.2.1 Low power mode

The low power mode means that the BLE function continues to run after entering this mode, and the peripherals except the wake-up pin are turned off. If you need lower power consumption, you can turn off the broadcast, scan, disconnect all connections, set a longer broadcast gap, scan the gap, and connect the gap by AT command.

Enter low power mode:

1. AT command “AT+SLEEP”: enter low power mode;
2. AT command “AT+DISCSLEEP=1”: disconnect and enter low power mode;
3. AT command “AT+ONSLEEP=1” : enter low power mode once power on;
4. Via pin WKP rising edge, keep high level for 200ms and enter low power mode;

To output “STA: sleep” via serial port after entering low power mode (LOGMSG output unclosed)。

Note: In low power mode, when it is not disconnected, for example, when ble receives data over air, or when the connection status changes, the module temporarily wakes up and outputs the corresponding data, and immediately goes to sleep after the data output is completed. At this point, entering low power consumption, or waking up will not output status data.

6.2.2 Wake up mode

In this mode, the peripherals of ble modules works normally. Once it waked up, it outputs “STA: wakeup”.

Wake up mode:

1. Via pin WKP falling edge, keep low level for 200ms and enter wake up mode;
2. Pin RX wakes up, via falling edge of pin RX, keep low level for at least 50us and wake up immediately。

6.3 Data transmission mode

There are two transmission mode: transparent transmission and format transmission.

6.3.1 Transparent transmission

It refers to the data received by the serial port is sent to the other device through BLE without any processing, and the data received by the BLE is sent through the serial port without any processing.

In slave mode, only data transparent transmission is available. The result of the command "AT+TRANMD" is invalid for the slave.

In master mode, data transparent transmission is sent to each connected slave module by advertising. Due to the use of broadcast transmission, under extreme conditions, there is no guarantee that each slave will be able to receive data. The host is set to the transparent transmission mode by the instruction "AT+TRANMD=1".

6.3.2 Format transmission

The data sent to the module through the serial port and the data transmitted through the serial port must be in accordance with the defined format and transmitted. It should be noted that the format transmission of the module also supports the transmission of data in a broadcast manner.

It is unavailable for slaves.

Send to slaves command "AT+TRANMD=0" to switch it to format mode. Format is as follows:

Slave ID	Valid data
1 byte	Max:243bytes
0~3/0xff	

- Slave ID: 0~3. It is printed by master from "STA:connect,1<mac>" after master and When slave ID is 0xff, every device is under advertising.
- Every packet output via uart is format transmission.
- If connection defined by slave ID doesn't exist, module will abandon this packet directly.

6.4 MAC address bonding

To enable MAC address bonding, the device connects only to devices with MAC added.

6.5 Advertising

6.5.1 Normal advertising info.

It includes advertising and scan response, advertising is actively sent report, scan response is responded report after receiving scan request from the master.

6.5.1.1 Advertising

Fixed field	Len	Manufa field	Manufa data
020106	N	0xFF	configurable, max is 26 bytes

For example: 020106< Len >FF< Manufa data >

Users can configure Manufa data only.

6.5.1.2 Scan response

Len	Fixed field	UUID	Len	Fixed field	Device name
0x03	0x03	FFF0	N	0x09	configurable, max is 22 bytes

For example: 0303FFF0<len>09< Device name >

Note: users do not need to configure this data.

6.5.2 iBeacon advertising info.

1. Commands are for UUID, Major, Minor.
2. AT+ADV=2: set to work in iBeacon mode to advertise immediately.
3. In iBeacon advertising, ble connection is unavailable.

6.5.2.1 Advertising

iBeacon Prefix	UUID	Major	Minor	Tx-Power
9B	16B	2B	2B	1B

For example: 0201061AFF4C000215FDAFDA50693A4E24FB1AFCFC6EB076478252775848F00

6.6 Configuration

There are two configuration modes: serial port configuration and air configuration. They are basically the same. Before the air configuration, the authentication password AT+AUTH=123456 must be passed. Once it is passed, the module is allowed to use the air configuration. The authentication period is the current connection. When disconnected and reconnected, it needs to be re-authenticated.

The module is in configuration mode before the connection is established. The Mod pin is invalid.

After the connection is successful, it is determined whether the module is currently in the configuration mode or the data transmission mode according to the mod pin level. When mod is high, it is the data transfer mode, and when it is low, it is the configuration mode.

The Mod pin latches the current state when a valid change is detected. Each state change hold time is valid for at least 200ms.

The Mod pin has no effect on the air configuration.

In configuration mode, the master sends data to “MAST CHANNEL” and the slave returns “CONFIG BUSY” via “SLAVE CHANNEL”.

6.7 Data indication

When data is output through the serial port, the DATA pin is set to low level, indicating that data is being transmitted. The AT command response does not change the state of the DATA pin.

Data output delay is enabled via with AT+DATAALY=1. After it is turned on, the module first pulls the DATA pin and outputs the data after 10ms.



Data output delay



No delay of data output

6.7.1 Output delay

If the output delay is turned on, after receiving the air data, the module first pulls down the DATA pin, and outputs the data through the UART after 10ms. It should be noted:

- After the output delay is enabled, streaming is not supported. The maximum data size of each packet is 244 bytes;
- After the output delay is turned on, if the air data packet is received too fast, the entire data packet will be lost.

The output delay is usually applied to the user MCU sleep situation. After the module receives the air packet, it wakes up the user MCU through the DATA pin. After the user MCU stabilizes, it outputs data through UART.

6.8 UUID specification

Service UUID	FFF0 (configurable)		
Characteristic value	UUID	Property	Description
SLAVE CHANNEL	FFF1 (configurable)	read / notify	Slave sends data, master receives data
MAST CHANNEL	FFF2 (configurable)	read / write	Maser sends data, slave receives data
CONFIG CHANNEL	FFF3 (unconfigurable)	read / write / notify	Channel for configuration over air

6.9 GPIO function

Up to 8 GPIO input and output configurations and up to 3 PWM outputs are available for this module. Among them PWM can be configured frequency, duty cycle. PWM, IO can be arbitrarily configured to the pins shown in the table

below.

Pin (P0.xx)	IO	PWM
2	Available	Available
3	Available	Available
4	Available	Available
5	Available	Available
6	Available	Available
7	Available	Available
25	Available	Available
26	Available	Available

GPIO function pin

Note:

1. When IO and PWM are not used, it is recommended to turn off the corresponding function, otherwise it will affect the low power performance of the module.
2. If GPIO is currently set. Before changing the function, the current function need to be closed.
3. PWM reset frequency is required. Close the current PWM before resetting it.
4. When setting GPIO, all are ordinary IO. No pull-up, no pull-down

6.9.1 Input and output

Input

1. Command AT+PINCONF=2,1, set pin 2 as input;
2. Command AT+ PINGET=2, set pin 2 as communication level;
Module returns +OK=0, means pin 2 is low communication level.

Output

1. Command AT+PINCONF=3,2, Set pin 3 as output;
2. Command AT+PINSET=3,1, set pin 3 as high communication level.

Restore to default state (turn off IO function)

1. Command AT+PINCONF=3,0.

6.9.2 PWM

1. Command AT+PWMCONF=2,100000,50. Set pin 2 as PWM, and frequency is 100KHZ, duty cycle is 50%.
2. Command AT+ PWMDUTYSET=2,10, set pin 2 as PWM and duty cycle is 10%.
3. Command AT+PWMUNINIT=2, turn off PWM.

6.10 Multilink

6.10.1 Connection handle

1. In the module master role, multiple masters and multiple slaves coexist, and the connection handle is the number of the specified link.
2. Normally, the link number range of the module connected in the role of master: 0 ~ 3; the link number range of the module connected in the role of slave: 4 ~ 7.
3. In principle, the handle of each module connection is not necessarily the same.
4. Even when the device is slaved, or after the number of connections is set using the AT command, the connection handle still complies with the second rule above.

6.10.2 Obtaining a connection handle

1. The module enables logmsg (logmsg must be turned on for multiple links) after printing. When a new link is established, the module returns "\r\nSTA: connect, [handle], [MAC] \r\n", where handle is the connection handle of the current link. For the sake of convenience, the connection handle is indicated by handle in the following.
2. Obtain his connection handle by instructing the MAC address of the other device (AT + LINKNUM = [mac]).

7. AT command

Note: keep module in wake-up mode before sending cooperation command.

7.1 Command instruction

- There is no enter (\r) or LF(\n) required for AT command.
- AT Command return info is ended with \r\n (except for return HEX)
- Command error response format +ERR=[NUM]. (NUM is ACSII)
- AT command parameter format: [para]. Include no [].

7.2 Error code

NUM	Description	Error reason	Solution
0	Currently parsing AT	Gap between two AT commands is too small	Proper delay is added between two AT commands

1	Command does not exist	AT command string is incorrect	Check AT command character string
2	Incorrect parameter length	1、 AT command length is incorrect; 2、 Length does not meet range	Check parameter
3	Invalid parameter	1 Parameter exceeds value range	Refer to command to check right parameter
4	Air wakeup authentication failed	Incorrect password	1、 Use correct configuration password; 2、 Reset password via UART
5	Current device role, this command is not supported		This command is forbidden in current role
6	Unknown mistake		
7	Save parameter error		
8	AT command exists, but operation not supported		Refer to command and operate again
9	Disconnected	Module is disconnected	
10	MAC address does not exist	Added MAC address exists already	
11	MAC list is full	MAC address bond exceeds the maximum numbers	Delete invalid MAC, add again
12	MAC address does not exist	Deleted MAC does not exist	
13	Connection failed		
14	Exceeded the maximum number of current connections	The current masters are all connected	1、 Disconnect current devices; 2、 Modify maximum connection numbers;
15	Device does not exist		
16	Connection does not exist	This error is returned when sending data or setting connection parameters. The cause of the error is that the connection handle does not exist.	1. Confirm whether the device has been disconnected; 2. Make sure the connection handle is correct
17	Configured pin does not exist	Pin error	
18	Pin is used already		
19	No resources available	All pins are used	
20	PIN not configured		
21	PIN function error	Parameter and current pin function do not match	

Error code list

7.3 Status printing

Status	Printing info	
Connected successfully	Only slave	\r\nSTA:connect\r\n
	Other	\r\nSTA:connect,[handle],[MAC]\r\n
Disconnect	Only slave	\r\nSTA:disconnect\r\n
	Other	\r\nSTA:disconnect,[handle]\r\n

System wake up	\r\nSTA:wakeup\r\n
Sleep mode	\r\nSTA:sleep\r\n

Status printing list

7.4 Command list

7.4.1 AT test command

command	respond
AT	+OK
Remark: None	

7.4.2 AT+RESET Reset command

command	respond
AT+RESET	+OK
Remark: take into effect immediately	

7.4.3 AT+RESTORE restore factory setting

command	respond
AT+RESTORE	OK
Remark: 1、 after the reset, automatically restart; 2、 During the process of restoring the factory settings, any form of reset is prohibited, must not power off before it is completed.;	

7.4.4 AT+BAUD baud rate

command		respond
Inquire	AT+BAUD?	+OK=[para]
Set	AT+BAUD=[para]	+OK: success +ERR=[NUM]: error

Parameter	para (ASCII)	Baud rate(bps)
	0	1200
	1	2400
	2	4800
	3	9600
	4	14400
	5	19200
	6	28800
	7	38400
	8	57600
	9	76800
	10	115200 (default)
	11	230400
	12	250000
	13	460800
14	921600	
Remark	take into effect after reset	
For example	AT+BAUD=10, baud rate is 115200 HEX: 41,54,2B,42,41,55,44,3D,31,30	

7.4.5 AT+PARI parity

Command		respond
Inquire	AT+PARI?	+OK=[para]
Set	AT+PARI=[para]	+OK: success +ERR=[NUM]: error
Parameter	para(ASCII)	Description
	0	None (default)
	1	Even
Remark	take into effect after reset and save when power off	
For example	AT+PARI=0	

7.4.6 AT+HWFC flow control

Command		Respond
Inquire	AT+HWFC?	+OK=[para]
Set	AT+ HWFC =[para]	+OK: success +ERR=[NUM]: error

Parameter	para(ASCII)	Description
	0	No flow control (default)
	1	Flow control
Remark	take into effect after reset and save when power off	
For example	AT+HWFC=0	

7.4.7 AT+ROLE Bluetooth role

Command		respond
Inquire	AT+ROLE?	+OK=[para]
Set	AT+ROLE =[para]	+OK: success +ERR=[NUM]: error
Parameter	Para(ASCII)	Description
	0	Slave (default)
	1	Master
	2	Observer
	3	Multiple masters and multiple slaves coexist
Remark	take into effect after reset and save when power off	

7.4.8 AT+DEVMANUF modify manufacture name

command		respond
Inquire	AT+DEVMANUF?	+OK=[para]
Set	AT+DEVMANUF =[para]	+OK: success +ERR=[NUM]: error
Parameter	para(string): manufacture name Default: CDEBYTE;	
Remark	1、 take into effect after reset and save when power off 2、 string is up to 32bytes	

7.4.9 AT+DEVSERIAL modify device serial

command		respond
Inquire	AT+DEVSERIAL?	+OK=[para]
Set	AT+ DEVSERIAL =[para]	+OK: success +ERR=[NUM]: error

Parameter	para(string): device serial default:123456;
Remark	1、 take into effect after reset and save when power off 2、 string is up to 32bytes

7.4.10 AT+DEVMODEL modify device model

	Command	respond
Inquire	AT+DEVMODEL?	+OK=[para]
Set	AT+ DEVMODEL =[para]	+OK: success +ERR=[NUM]: error
Parameter	para(string): device model NO. Default: E104-BT50	
Remark	1、 take into effect after reset and save when power off 2、 string is up to 32 bytes	

7.4.11 AT+DEVHWVER modify hardware version

	Command	respond
Inquire	AT+DEVHWVER?	+OK=[para]
Set	AT+ DEVHWVER =[para]	+OK: success +ERR=[NUM]: error
Parameter	para(string): device hardware version Default: V1.0	
Remark	1、 take into effect after reset and save when power off 2、 string is up to 32bytes	

7.4.12 AT+DEVSWVER modify software version

	command	respond
Inquire	AT+DEVSWVER?	+OK=[para]
Set	AT+ DEVSWVER =[para]	+OK: success +ERR=[NUM]: error
Parameter	para(string): device software version Default: V1.0;	
Remark	1、 take into effect after reset and save when power off 2、 string is up to 32bytes	

7.4.13 AT+DEVID modify device ID

command		respond
Inquire	AT+DEVID?	+OK=[para]
Set	AT+ DEVID =[para]	+OK: success +ERR=[NUM]: error
Parameter	para (HEX) :device ID; Default: <MAC> 00 00	
Remark	1、 take into effect after reset and save when power off; 2、 Max length is 8bytes	

7.4.14 AT+ADV enable advertising

command		respond
Inquire	AT+ADV?	+OK=[para]
Set	AT+ADV=[para]	+OK: success +ERR=[NUM]: error
Parameter	para (ASCII)	Description
	0	Close advertising
	1	Normal advertising (default)
	2	iBeacon
Remark	1、 Take into effect immediately (if advertising is not enabled, or it is connected, then take into effect next time) , save when power off; 2、 Available for slave only.	

7.4.15 AT+ADV DAT advertising data

command		respond
Inquire	AT+ADV DAT?	+OK=[para]
Set	AT+ADV DAT=[para]	+OK: success +ERR=[NUM]: error
Set (do not save)	AT+ADV DAT1=[para]	
Parameter	para(HEX): 1、 Available for ASCII、 HEX 2、 Length is within 26 bytes	
Remark	1、 Take into effect immediately (if advertising is not enabled, or it is connected, then take into effect next time) , save when power off; 2、 Advertising available for slave only, other role can configurate;	
For example	command: 41 54 2b 41 44 56 44 41 54 3d 31 32 33 34 35 36 37 38 39 30; advertising data: 31 32 33 34 35 36 37 38 39 30	

7.4.16 AT+ADVINTV advertising gap

command		respond
Inquire	AT+ADVINTV?	+OK=[para]
Set	AT+ADVINTV=[para]	+OK: success +ERR=[NUM]: error
Parameter	para(ASCII):32~16384 Default: 1600 (1S)	
Remark	1、 Take into effect immediately (if advertising is not enabled, or it is connected, then take into effect next time), save when power off; 2、 Advertising available for slave only, other role can configure;	
For example	AT+ADVINTV=1600 Set advertising gap: 1600*0.625=1S	

7.4.17 AT+IBCNUUID iBeacon UUID command

command		respond
Inquire	AT+IBCNUUID?	+OK=[para1]
Set	AT+IBCNUUID=[para]	+OK: success +ERR=[NUM]: error
Parameter	para(HEX): 16 bit UUID	
Remark	1、 Take into effect immediately (if advertising is not enabled, or it is connected, then take into effect next time), save when power off; 2、 Advertising available for slave only, other role can configure;	
For example	Set iBeacon UUID: "FDA50693A4E24FB1AFCFC6EB07647825"AT+IBCNUUID=FDA50693A4E24FB1AFCFC6EB07647825	

7.4.18 AT+MAJOR iBeacon Major Command

command		respond
Inquire	AT+MAJOR?	+OK=[para]
Set	AT+MAJOR=[para]	+OK: success +ERR=[NUM]: error
Parameter	para(ASCII): 1~65535 Default: 513	
Remark	1. Take into effect immediately (if advertising is not enabled, or it is connected, then take into effect next time), save when power off; 2. Advertising available for slave only, other role can configure;	

7.4.19 AT+MINOR iBeacon Minor command

command		respond
Inquire	AT+Minor?	+OK=[para]
Set	AT+Minor=[para]	+OK: success +ERR=[NUM]: error
Parameter	para(ASCII): 1~65535 Default: 1027	
Remark	1. Take into effect immediately (if advertising is not enabled, or it is connected, then take into effect next time), save when power off; 2. Advertising available for slave only, other role can configurate;	

7.4.20 AT+IPWR modify ibeacon tx_power

command		respond
Inquire	AT+IPWR?	+OK=[para]
Set	AT+ IPWR =[para]	+OK: success +ERR=[NUM]: error
Parameter	para(ASCII): -128~127 Default: 0	
Remark	1. Take into effect immediately (if advertising is not enabled, or it is connected, then take into effect next time), save when power off; 2. Advertising available for slave only, other role can configurate;	

7.4.21 AT+NAME advertise device name

command		respond
Inquire	AT+NAME?	+OK=[para]
Set	AT+NAME=[para]	+OK: success +ERR=[NUM]: error
Set (Do not save)	AT+NAME1=[para]	
Parameter	para(HEX): advertise device name device name is within 22 bytes Default: E104-BT5032A	
Remark	1、 Take into effect immediately, save when power off. AT+NAME1 does not save. 2、 Advertising available for slave only, other role can configurate	

7.4.22 AT+CONPARAMS connection gap configuration

command	respond
---------	---------

Inquire	AT+CONPARAMS?	+OK=[intv],[latency],[timeout]
Set	AT+ CONPARAMS = [intv],[latency],[timeout]	+OK: success +ERR=[NUM]: error
Parameter	[intv] (ASCII) : connection gap, range, 6~3200; [latency] (ASCII) : slave delay. range, 0~499 [timeout] (ASCII) : connection timeout, range, 10~3200 Default: 16, 0, 400	
Remark	Take into effect immediately, save when power off	
Note	1、 Connection timeout must be more than connection interval 2、 Timeout *4 > (1 + latency)* intv; 3、 Error parameter device will not save 4 、 Only the default parameters of the connection parameters are set. After the setting is completed, it does not affect the currently connected links. 5 、 It is not recommended to set the connection parameters of the host too large. This will cause the connection time to be too long, and during the connection process, all data received by the serial port is discarded.	
For example	AT+CONPARAMS=16,0,400 Connection gap 16*1.25ms,slave will delay: 0, 16*1.25ms, connection timeout 400*1.25ms	

7.4.23 AT+CONPARAMSx specified connection interval setting

	command	respond
Set	AT+ CONPARAMSx=[handle], [intv],[latency],[timeout]	+OK: success +ERR=[NUM]: error
Parameter	[handle][ASCII] : connection handle (refer to 6.10) value range, 0~7.It is from the connection state printing. [intv] (ASCII) : connection interval, range, 6~3200; [latency] (ASCII) : salve delay: range, 0~499 [timeout] (ASCII) : connection timeout, range, 10~3200 Default: 16, 0, 400	
Remark	Take into effect immediately.	
Note	1、 Connection timeout must be more than connection interval; 2、 Timeout *4 > (1 + latency)* intv; 3、 Error parameter device will not save 4、 Take into effect immediately, do not save; 5、 This command is for modifying connection parameter for specified link; 6、 Even if the connection parameter modification returns "OK", it does not mean that the connection	

	<p>parameter modification is successful. During the negotiation process between the master and the slave, if the other device refuses to modify, the connection can only be made according to the connection parameters of the other device.</p> <p>7、 This command is good for firmware: V1.1</p>
For example	<p>AT+CONPARAMSx=2,16,0,400</p> <p>Connection interval 16*1.25ms, the delay of salve: 0, 16*1.25ms,connection timeout 400*1.25ms</p>

7.4.24 AT+DISCON disconnect command

command		respond
Set (only for master)	AT+DISCON=[<i>handle</i>]	+OK: success +ERR=[NUM]: error
Disconnect all	AT+DISCON	+OK: success +ERR=[NUM]: error
Parameter	<i>handle</i> (ASCII)	description
	0~7	Disconnect specified connection
Remark	1 Take into effect immediately. 2 As slave, only disconnect all is available; 3 Disconnect all is available for master and slave mode; 4 If <i>handle</i> specified connection is not connected, the module will return error; 5 For Handle please refer to 6.10 multilink.	

7.4.25 AT+DATDLY Data output delay

command		respond
Query	AT+DATDLY?	+OK=[para]
Set	AT+DATDLY=[para]	+OK: success +ERR=[NUM]: error
Parameter	para (ASCII)	description
	0	close
	1	enable(default)
Remarks	1 Take into effect immediately, save when power off 2 Turn on the output delay, the maximum packet size does not exceed 244 bytes; 3 Turn on the output delay. If the air packet input is too fast, the entire packet will be lost.	

7.4.26 AT+MAC local MAC address

command		respond
Query	AT+MAC?	+OK=[para]
Parameter	para (HEX) :MAC address For example: F0E1D2C3B4A5	
Remarks	Take into effect immediately, save when power off	
For example	Command: AT+MAC? Return: 2B 4F 4B 3D FE 30 EE 50 35 DA Description: local MAC is FE 30 EE 50 35 DA	

7.4.27 AT+PEERMAC connect to device MAC

command		respond
Set (only for master ROLE=1)	AT+PEERMAC?	+OK=[para]: success +ERR=[NUM]: error
Query specified connected MAC address	AT+PEERMAC=[handle]	
Parameter	MAC (HEX) :MAC address; <i>handle</i> (string):specify connection handle. Refer to 6.10 multilink;	
For example	Command: AT+PEERMAC? Return: 2B 4F 4B 3D FE 30 EE 50 35 DA Description: connected device MAC is FE 30 EE 50 35 DA	

7.4.28 AT+BOND enable bonding

command		respond
Query	AT+BOND?	+OK=[para]
Set	AT+BOND=[para]	+OK: success +ERR=[NUM]: error
Parameter	para (ASCII)	description
	0	Bonding disabled (default)
	1	Enable bonding
Remarks	Take into effect immediately, save when power off	

7.4.29 AT+BONDMAC add more bond MAC address

command		respond
Query	AT+BONDMAC?	+OK=[sum][[mac] [mac]...]
Set	AT+BONDMAC=[mac]	+OK success +ERR=[NUM]: error
Parameter	sum(HEX): current bond MAC address numbers; mac(HEX): 6bytes mac address;	
Remarks	Take into effect immediately, save when power off	
For example	Query: AT+BONDMAC? Return: B 4F 4B 3D 03 CC 34 27 1A 0C D4 3D AC 82 16 0F 58 D2 D4 C3 07 0E C4	
	Set: 41 54 2B 42 4F 4E 44 4D 41 43 3D CC 34 27 1A 0C D4 Return: +OK	

7.4.30 AT+BONDDEL delete bond MAC address

command		respond
Set	AT+BONDDEL=[mac]	+OK +ERR=[NUM]
Parameter	mac: 6bytes mac address	
Remarks	1、 Take into effect immediately, save when power off 2、 When MAC is (0xff,0xff,0xff,0xff,0xff,0xff) delete all MAC address, or delate specified mac address;	

7.4.31 AT+SCAN advertising scan

command		respond						
Query	AT+SCAN?	+OK=[para]						
Set	AT+SCAN=[para]	+OK: success +ERR=[NUM]: error						
Parameter	<table border="1"> <thead> <tr> <th>para (ASCII)</th> <th>Description</th> </tr> </thead> <tbody> <tr> <td>0</td> <td>Scan closed</td> </tr> <tr> <td>1</td> <td>Scan enabled(default)</td> </tr> </tbody> </table>		para (ASCII)	Description	0	Scan closed	1	Scan enabled(default)
	para (ASCII)	Description						
	0	Scan closed						
1	Scan enabled(default)							
Remarks	1、 Take into effect immediately, save when power off 2、 If current connected masters are the maximum, no scanning will be enabled 3、 Scanning is only available for master and observer							

7.4.32 AT+SCANINTV scan interval

command		Respond
Query	AT+SCANINTV?	+OK=[para]
Set	AT+SCANINTV=[para]	+OK: success +ERR=[NUM]: error
Parameter	para(ASCII):4~65535 Default: 160	
Remarks	1、 Take into effect immediately, save when power off 2、 Scanning interval is more than scanning window 3、 Unavailable for slave, but configuration is ok	
For example	AT+SCANINTV=120 Interval: $120 * 0.625 = 75\text{ms}$	

7.4.33 AT+SCANWND scan window

command		respond
Query	AT+SCANWND?	+OK=[para]
Set	AT+SCANWND=[para]	+OK: success +ERR=[NUM]: error
Parameter	para(ASCII): 4~65535 Default: 80;	
Remarks	1、 Take into effect immediately, save when power off 2、 Scanning interval is more than scanning window 3、 Unavailable for slave, but configuration is ok	
For example	AT+SCANWND=20 Interval: $20 * 0.625 = 12.5\text{ms}$	

7.4.34 AT+AUTOCONN connect automatically

command		respond						
Query	AT+AUTOCONN?	+OK=[para]						
Set	AT+ AUTOCONN =[para]	+OK: success +ERR=[NUM]: error						
Parameter	<table border="1" style="margin-left: auto; margin-right: auto;"> <thead> <tr> <th>para (ASCII)</th> <th>Description</th> </tr> </thead> <tbody> <tr> <td>0</td> <td>Manual connection</td> </tr> <tr> <td>1</td> <td>Automatic connection (default)</td> </tr> </tbody> </table>		para (ASCII)	Description	0	Manual connection	1	Automatic connection (default)
para (ASCII)	Description							
0	Manual connection							
1	Automatic connection (default)							
Remarks	1、 Take into effect immediately, save when power off							

7.4.35 AT+CONN specify connection

command		respond
Set	AT+ CONN = [mac]	+OK: success +ERR=[NUM]: error
Parameter	mac(hex): specify mac connection	
Remarks	1、 Take into effect immediately, save when power off	

7.4.36 AT+LINKNUM query link

command		respond
Query link number	AT+LINKNUM?	+OK=[num]
Query specified link number	AT+ LINKNUM =[mac]	+OK= [handle] : success +ERR=[NUM]: error
Parameter	num(ASCII):current connection total number; handle:(ASCII): Specify the connection handle corresponding to the MAC address (refer to 6.10 Multilink). mac(HEX):mac address	
Remark	1、 Take into effect immediately	

7.4.37 AT+TRANMD master transmission mode

command		respond						
Query	AT+TRANMD?	+OK=[para]						
Set	AT+ TRANMD =[para]	+OK: success +ERR=[NUM]: error						
Parameter	<table border="1"> <thead> <tr> <th>para (ASCII)</th> <th>Description</th> </tr> </thead> <tbody> <tr> <td>0</td> <td>Non-transparent transmission (default)</td> </tr> <tr> <td>1</td> <td>Transparent transmission</td> </tr> </tbody> </table>		para (ASCII)	Description	0	Non-transparent transmission (default)	1	Transparent transmission
	para (ASCII)	Description						
	0	Non-transparent transmission (default)						
1	Transparent transmission							
Remarks	1、 Take into effect immediately, save when power off							

7.4.38 AT+LINKMAX Master max link quantity

command		respond
Query	AT+LINKMAST?	+OK=[para]
Set	AT+ LINKMAST =[para]	+OK: success +ERR=[NUM]: error
Parameter	para(ASCCII): max link quantity. range: 1~4 default: 4	

Remarks	<ol style="list-style-type: none"> 1. Take effect immediately, save after power off. 2. If 4 devices are currently connected, but 2 are set at this time, the master will not disconnect the connected devices. 3. The instruction supports firmware version: V1.1. 4. The number of connections is limited to automatic connections only.
---------	--

7.4.39 AT+LINKSLAVE Slave max link quantity

command		respond
Query	AT+LINKSLAVE?	+OK=[para]
Set	AT+LINKSLAVE=[para]	+OK: success +ERR=[NUM]: error
Parameter	para(ASCII): max link quantity. range: 1~4 Default: 4	
Remarks	<ol style="list-style-type: none"> 1. Take effect immediately, save after power off. 2. If 4 devices are currently connected, but 2 are set at this time, the slave will not disconnect the connected devices. 3. The instruction supports firmware version: V1.1. 4. The number of connections is limited to automatic connections only. 	

7.4.40 AT+UUIIDSVR128 set 128-bit UUID

command		respond
Query	AT+UUIIDSVR128?	+OK=[para]
Set	AT+UUIIDSVR128=[para]	+OK: success +ERR=[NUM]: error
Parameter	para(HEX):16-bit uuid.	
Remarks	<ol style="list-style-type: none"> 1、 take into effect after reset and save when power off. 2、 the 2, 3byte is 16-bit uuid, ranging from 1~65535; 3、 128-bit UUID, except for 2, 3byte, are used for the slave, the master and configuration channel.(Check details about uuid from 《BLUETOOTH SPECIFICATION Version 5.0 Vol 3, Part B 2.5.1 UUID》). 	
For example	Set 128-bit UUID: "11 22 33 44 55 66 77 88 99 00 aa bb cc dd ee ff"(HEX) AT command is (HEX) : 61 74 2b 75 75 69 64 73 76 72 31 32 38 3d 11 22 33 44 55 66 77 88 99 00 aa bb cc dd ee ff	

7.4.41 AT+UUIDSVR Bluetooth service UUID

command		respond
Query	AT+UUIDSVR?	+OK=[para]
Set	AT+UUIDSVR=[para]	+OK: success +ERR=[NUM]: error
Parameter	para(ASCII): UUID value 1 ~ 65535	
Remarks	1、 Take into effect after reset, save when power off 2、 for the master, service UUID is necessary for connection filtering, thus master UUID shall be same as that of the slave.	

7.4.42 AT+UUIDCHARA1 SLAVE CHANNEL characteristic UUID

command		respond
Query	AT+UUIDCHARA1?	+OK=[para]
Set	AT+UUID CHARA1= [para]	+OK: success +ERR=[NUM]: error
Parameter	para(ASCII): 1 ~ 65535 Default: 65521	
Remarks	1、 Take into effect after reset, save when power off 2、 The slave channel for data sent from the slave to the master.	

7.4.43 AT+UUIDCHARA2 MAST CHANNEL characteristic UUID command

command		respond
Query	AT+UUIDCHARA2?	+OK=[para]
Set	AT+UUID CHARA2= [para]	+OK: success +ERR=[NUM]: error
Parameter	para(ASCII): 1 ~ 65535; Default: 65522	
Remarks	1、 Take into effect after reset, save when power off 2、 The master channel for data sent from the master to the slave.	

7.4.44 AT+VER query software version No.

Command		respond
Query	AT+VER?	+OK=[para]
Parameter	para: version NO.	
Remarks	Take into effect immediately	
For example	command: AT+VER?	

	return: +OK=1.0.0
--	-------------------

7.4.45 AT+AUTH set authentication password over air

command		respond
Set	AT+AUTH =[para]	+OK: success +ERR=[NUM]: error
Parameter	para(HEX): 6-byte password	
Remarks	1、 This command is for set over air 2、 Default password (ASCII): 123456 3、 <i>This command is unavailable after successful authentication.</i>	
For example	AT+AUTH=123456	

7.4.46 AT+UPAUTH change authentication password over air

command		respond
Query	AT+UPAUTH?	+OK=[para]
Set	AT+UPAUTH =[para]	+OK: success +ERR=[NUM]: error
Parameter	para(HEX): 6-byte password	
Remarks	Take into effect immediately, save after power off	

7.4.47 AT+PWR transmitting power

command		respond
Query	AT+ PWR?	+OK=[para]
Set	AT+ PWR =[para]	+OK: success +ERR=[NUM]: error
Parameter	para(ASCII)	val
	0	4 dBm
	1	3 dBm
	2	0 dBm (default)
	3	-4 dBm
	4	-8 dBm
	5	-12 dBm
	6	-16 dBm
	7	-20 dBm
	8	-40 dBm
Remarks	Take into effect immediately, save after power off	

7.4.48 AT+ONSLEEP sleep once power on

command		respond						
Query	AT+ONSLEEP?	+OK=[para]						
Set	AT+ONSLEEP =[para]	+OK: success +ERR=[NUM]: error						
Parameter	<table border="1"> <thead> <tr> <th>para (ASCII)</th> <th>Description</th> </tr> </thead> <tbody> <tr> <td>0</td> <td>Disenable(default)</td> </tr> <tr> <td>1</td> <td>Enable</td> </tr> </tbody> </table>		para (ASCII)	Description	0	Disenable(default)	1	Enable
	para (ASCII)	Description						
	0	Disenable(default)						
1	Enable							
Remarks	Take into effect immediately, save after power off							

7.4.49 AT+DISCSLEEP disconnect and get into sleep

command		respond						
Query	AT+DISCSLEEP?	+OK=[para]						
Set	AT+DISCSLEEP =[para]	+OK: success +ERR=[NUM]: error						
Parameter	<table border="1"> <thead> <tr> <th>para (ASCII)</th> <th>description</th> </tr> </thead> <tbody> <tr> <td>0</td> <td>Disconnect (default)</td> </tr> <tr> <td>1</td> <td>Disconnect and get into sleep</td> </tr> </tbody> </table>		para (ASCII)	description	0	Disconnect (default)	1	Disconnect and get into sleep
	para (ASCII)	description						
	0	Disconnect (default)						
1	Disconnect and get into sleep							
Remarks	Take into effect immediately, save after power off							

7.4.50 AT+SLEEP get into sleep mode immediately

command		respond
Set	AT+SLEEP	+OK
Parameter	None	
Remarks	Take into effect immediately	

7.4.51 AT+LOGMSG operating condition output

command		respond
Query	AT+LOGMSG?	+OK=[para]
Set	AT+LOGMSG =[para]	+OK: success +ERR=[NUM]: error

Parameter	para (ASCII)	description
	0	Disenable(default)
	1	Enable
Remarks	Take into effect immediately, save after power off	

7.4.52 AT+PINCONF IO configuration

	command	respond
Set	AT+PINCONF =[pin],[mode]	+OK: Success +ERR=[NUM]: Error
Parameter	1、PIN is command pin. Refer to figure: GPIO function pins.	
	2、mode parameter is as follows	
	mode (ASCII)	description
	0	Turn off(default)
	1	input
	2	output
Remarks	1. Take into effect immediately, do not save once power off. 2. Only available for firmware: V1.1	

7.4.53 AT+PINSET Set IO high and low level

	command	respond
Set	AT+ PINSET =[pin],[sta]	+OK: Success +ERR=[NUM]: Error
Parameter	1、PIN is command pin. Refer to figure: GPIO function pins	
	2、sta parameter:	
	sta (ASCII)	description
	0	Low level
	1	High level
Remarks	1. Take into effect immediately, do not save once power off 2. Only available for output mode 3. Only available for firmware: V1.1	

7.4.54 AT+PINGET Obtain IO high and low level

command		respond
Set	AT+ PINGET =[pin]	+OK=[sta] Success +ERR=[NUM]: Error
Parameter	1、 PIN is command pin. Refer to figure: GPIO function pins	
	2、 sta parameter:	
	sta (ASCII)	description
	0	Low level
	1	High level
Remarks	1. Take into effect immediately, do not save once power off 2. Only available for input mode 3. Only available for firmware: V1.1	

7.4.55 AT+PWMCONF PWM configuration

command		respond
Set	AT+ PWMCONF =[pin],[freq],[duty]	+OK: Success +ERR=[NUM]: Error
Parameter	1. PIN is command pin. Refer to figure: GPIO function pins.	
	2. Freq is specified frequency. Range: 4HZ ~ 160KHZ. Unit: HZ	
	3. Duty is cycle duty. Range: 1 ~ 100.	
	4. All parameter is positive integer.	
Remarks	1. Take into effect immediately, do not save once power off 2. Only available for firmware: V1.1	

7.4.56 AT+PWMUNINIT Turn off PWM function

command		respond
Set	AT+PWMUNINIT =[pin]	+OK: Success +ERR=[NUM]: Error
Parameter	1、 PIN is command pin. Refer to figure: GPIO function pins	
Remarks	1. Take into effect immediately, do not save once power off	

	<ol style="list-style-type: none"> 2. Only valid for PWM module 3. Only valid for firmware: V1.1
--	--

7.4.57 AT+PWMDUTYSET Change PWM cycle duty

	command	respond
Set	AT+PWMDUTYSET =[pin], [duty]	+OK: Success +ERR=[NUM]: Error
Parameter	<ol style="list-style-type: none"> 1、 PIN is command pin. Refer to figure: GPIO function pins 2、 duty is cycle duty. Range: 1 ~ 100 	
Remarks	<ol style="list-style-type: none"> 1. Take into effect immediately, do not save once power off 2. Only valid for PWM module 3. Only valid for firmware: V1.1 	

7.4.58 AT+FILTER Device master filtering conditions

	command	respond														
Set	AT+FILTER =[type], [sta]	+OK: Success +ERR=[NUM]: Error														
Parameter	<table border="1" style="width: 100%; border-collapse: collapse;"> <tr> <td colspan="2">[type]</td> </tr> <tr> <td style="text-align: center;">Type</td> <td style="text-align: center;">description</td> </tr> <tr> <td style="text-align: center;">1</td> <td style="text-align: center;">Filter according to name</td> </tr> <tr> <td colspan="2">[sta]</td> </tr> <tr> <td style="text-align: center;">Sta</td> <td style="text-align: center;">description</td> </tr> <tr> <td style="text-align: center;">0</td> <td style="text-align: center;">Turn off filtering</td> </tr> <tr> <td style="text-align: center;">1</td> <td style="text-align: center;">Turn on filtering</td> </tr> </table>		[type]		Type	description	1	Filter according to name	[sta]		Sta	description	0	Turn off filtering	1	Turn on filtering
[type]																
Type	description															
1	Filter according to name															
[sta]																
Sta	description															
0	Turn off filtering															
1	Turn on filtering															
Remarks	<ol style="list-style-type: none"> 1. Take into effect immediately, do not save once power off 2. Only valid for firmware: V1.1 															
For example	The master filter with name "E104-BT50". <ol style="list-style-type: none"> 1. Set the filter name (default name: E104-BT5032A), and instruct AT + NAME = E104-BT50 or AT + NAME1 = E104-BT50. 2. Turn on name filtering. Command AT + FILTER = 1,1; As a result, the master only contains "E104-BT50" in front of the name, such as "E104-BT5032A", "E104-BT5010A", and so on.															

8. Quick start

Recommended debugging and testing software:

- Serial tool on PC - SSCOM.exe;
- Ble debugging APP on phone- nRF connect.

8.1 Guidance for configuration mode

8.1.1 UART configuration

- Check if the module is in configuration mode (When not connected, it can be configured, otherwise, set pin mod as low level)
- Set SSCOM string related parameter (default: 115200, 8, 1, none, no flow control) ;

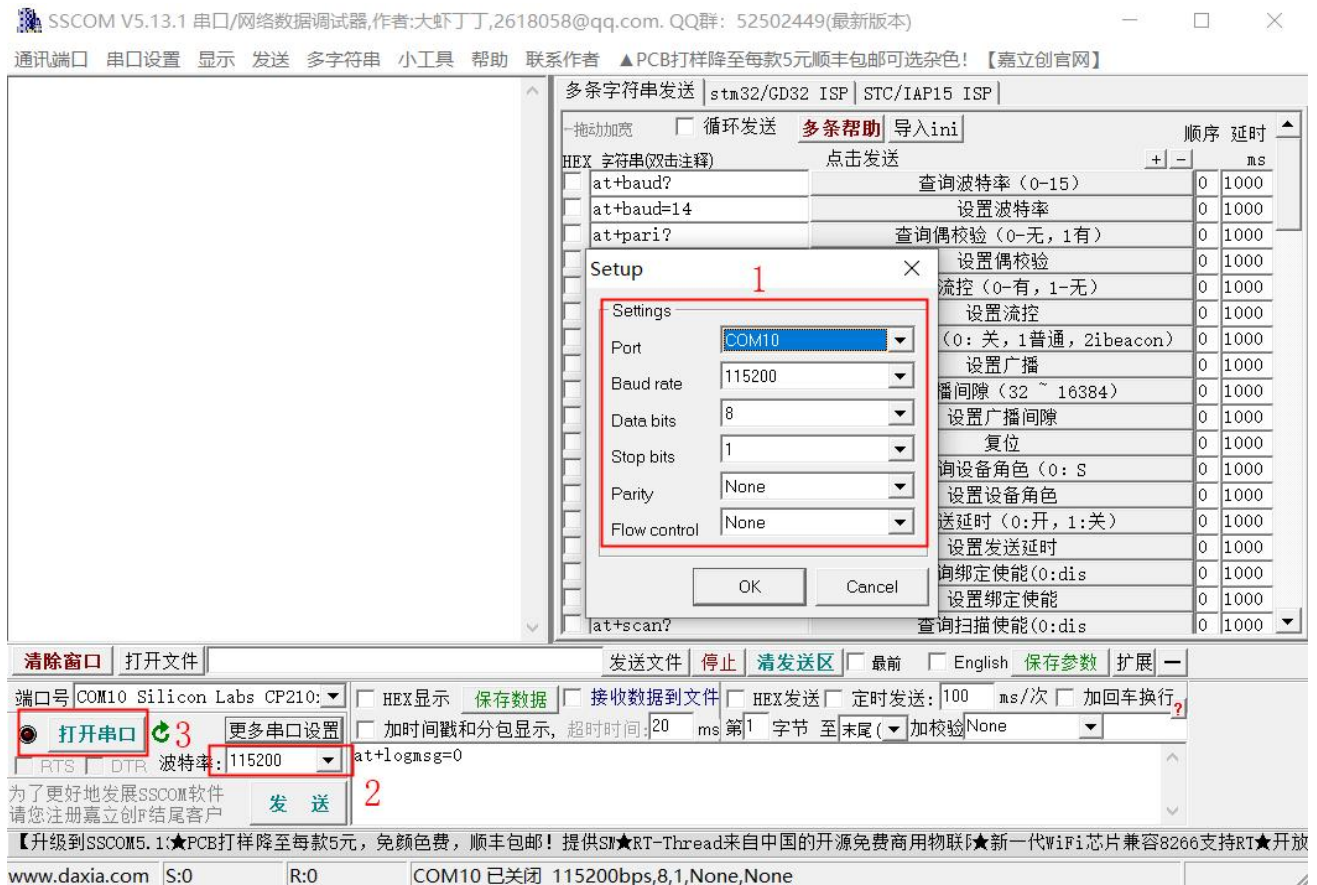

SSCOM parameter setting figure

- Refer to 6.4 command list to configure the module;

8.1.2 Configuration over air

- When module works as the slave, configuration over air is available.
- Open app “nRF connect”, start scanning device, find “E104-BT5032A” to connect;

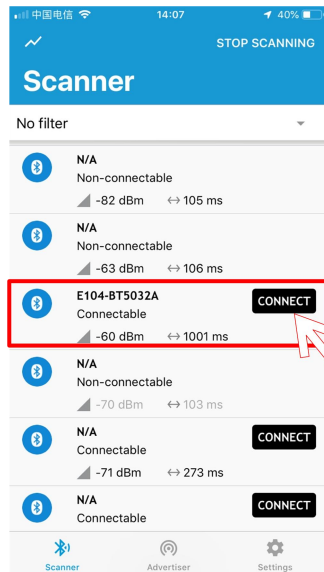

nRF connect scanning figure

- Open service fff0 of uuid, enable configuration channel notify;

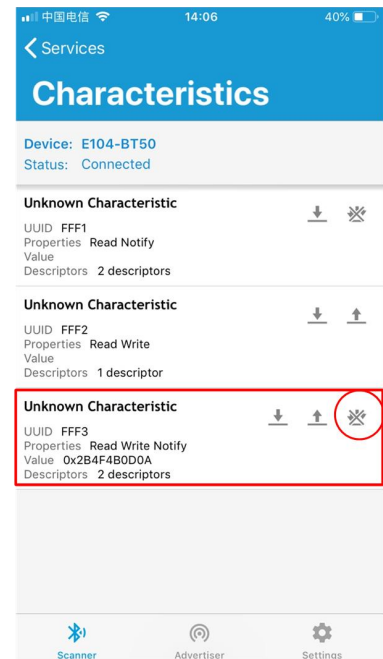
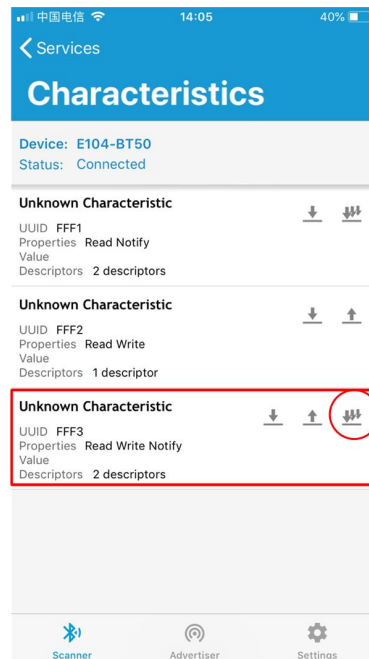
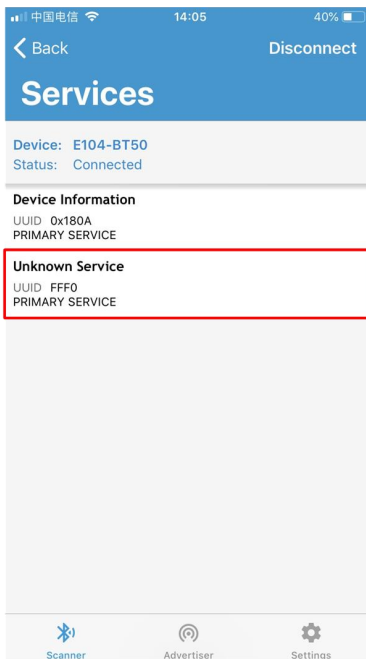

nRF connect-connect and enable notify

- Send authentication command (at+auth=12345), when it returns “0x2befeb0d0a (+OK\r\n)”, means successful authentication;

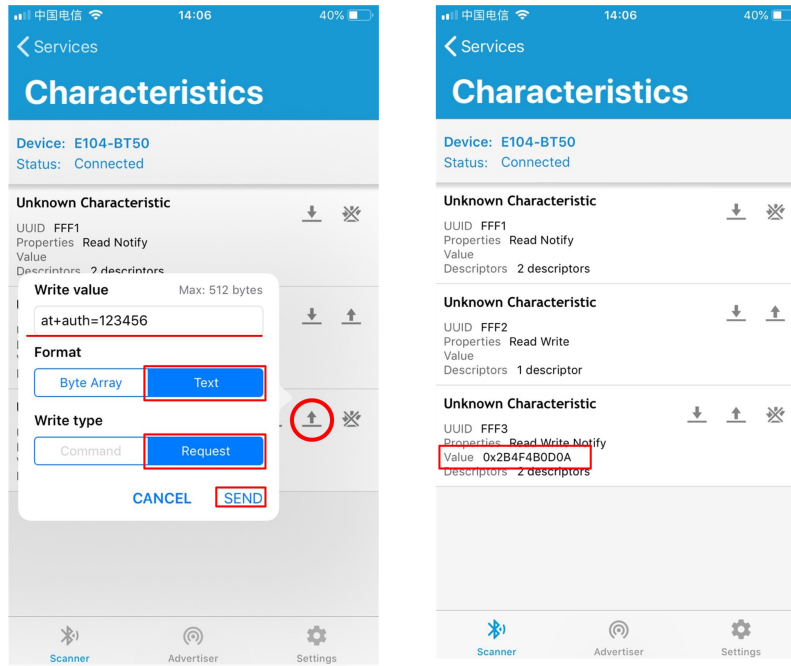

Authentication of configuration over air

- Refer to 6.4 command list to configure the module;

8.2 Data transmission

Please refer to 5.3 data transmission mode for details.

Test condition:

- Refer to 7.1, set one module as the master and the other one as the slave;
- Test software: SSCOM;
- Other parameters are as default.

8.2.1 Data transparent transmission

1. Once powered on, the master and the slave enable logmsg to print (at+logmsg=1) ;
2. Set module as transparent transmission mode (AT+TRANMD=1) ;
3. Once connected , the master prints “STA:connect,0,619AA43CBAF3”; the slave prints “STA:connected”. LINK pin is low.

Please refer to figure below. From master’s printing info, the value before the MAC address is sentences from the slave, where the first byte of format transmission comes.

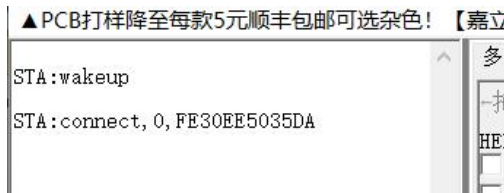

Automatically connect and print once the master is powered on

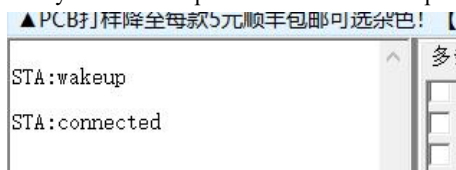

Automatically connect and print once the slave is powered on

4. Data “0123456789” is sent from the master to the slave (refer to master’s transparent transmission below) ;
5. Data “abcdefghijk” is sent from the slave to the master (refer to master’s transparent transmission below);

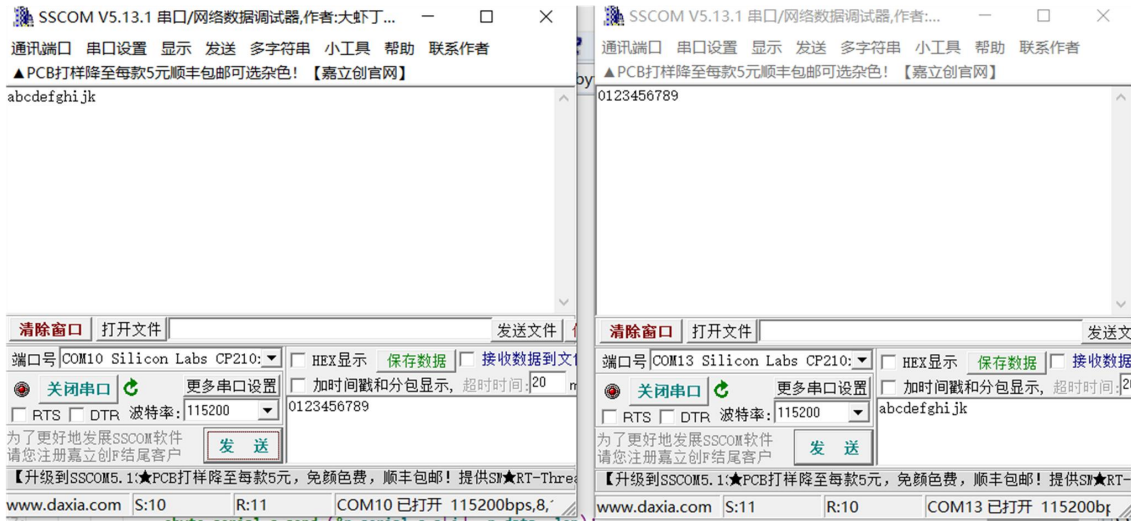

Master’s transparent transmission

8.2.2 Format transmission

1. Refer to 6.2.1 Data transparent transmission, Step 1;
2. Set the master as format transmission (default, set command “AT+TRANMD=0”)
3. Refer to 6.2.1 Data transparent transmission, Step 3;
6. Valid data “123456789” (ASCII) sent from the master to the slave. Format transmission pack “00 30 31 32 33 34 35 36 37 38 39” (HEX) and the slave receives data “123456789” (“30 31 32 33 34 35 36 37 38 39”), for example:

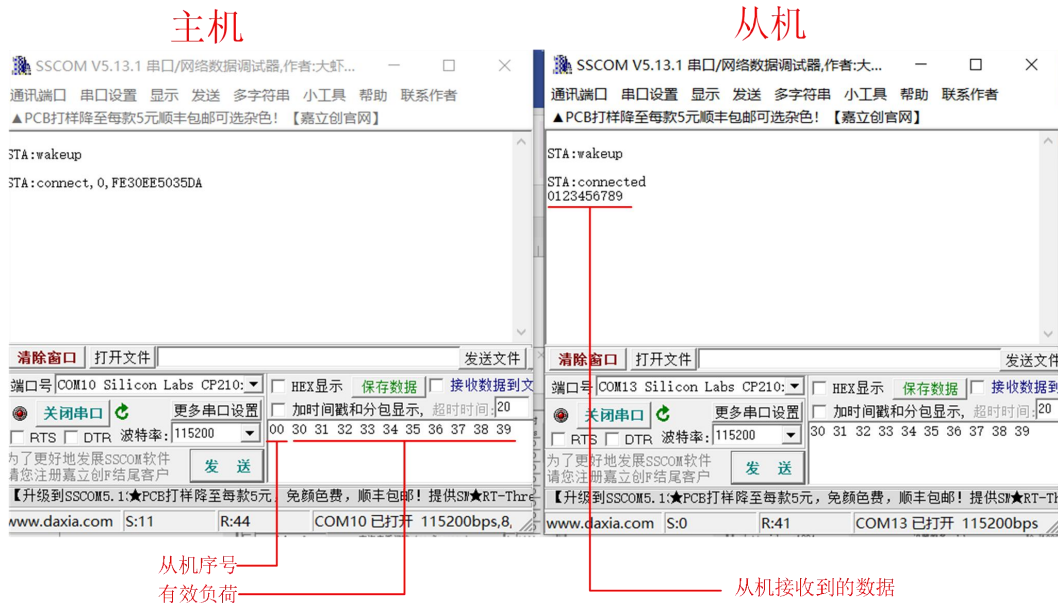

Format transmission-data from master to slave

7. Data "0123456789"(ASCII) is sent from the master to the slave, the master receives "00 30 31 32 33 34 35 36 37 38 39" (HEX), the first byte received by the master indicates where the data is sent from. Please refer to the figure below.



Format transmission-data from slave to master

9. Hardware design

- It is recommended to use a DC stabilized power supply. The power supply ripple factor is as small as possible and the module needs to be reliably grounded.
- Please pay attention to the correct connection of the positive and negative poles of the power supply.
- Reverse connection may cause permanent damage to the module;
- Please check the power supply to ensure it is within the recommended voltage otherwise when it exceeds the maximum value the module will be permanently damaged;
- Please check the stability of the power supply, the voltage cannot be fluctuated frequently;
- When designing the power supply circuit for the module, it is often recommended to reserve more than 30% of the margin, so the whole machine is beneficial for long-term stable operation.
- The module should be as far away as possible from the power supply, transformers, high-frequency wiring and other parts with large electromagnetic interference
- High-frequency digital routing, high-frequency analog routing, and power routing must be avoided under the module. If it is necessary to pass through the module, assume that the module is soldered to the Top Layer, and the copper is spread on the Top Layer of the module contact part(well grounded), it must be close to the digital part of the module and routed in the Bottom Layer;
- Assuming the module is soldered or placed over the Top Layer, it is wrong to randomly route over the Bottom Layer or other layers, which will affect the module's spurs and receiving sensitivity to varying degrees.
- It is assumed that there are devices with large electromagnetic interference around the module that will greatly affect the performance. It is recommended to keep them away from the module according to the strength of the interference. If necessary, appropriate isolation and shielding can be done;
- Assume that there are traces with large electromagnetic interference (high-frequency digital, high-frequency analog, power traces) around the module that will greatly affect the performance of the module. It is recommended to stay away from the module according to the strength of the interference. If necessary, appropriate isolation and shielding can be done.
- Try to stay away from some physical layers such as TTL protocol at 2.4GHz , for example: USB3.0;
- The mounting structure of antenna has a great influence on the performance of the module. It is necessary to ensure that the antenna is exposed, preferably vertically upward. When the module is mounted inside the case, use a good antenna extension cable to extend the antenna to the outside;
- The antenna must not be installed inside the metal case, which will cause the transmission distance to be greatly weakened.

10. FAQ

10.1 Communication range is too short

- The communication distance will be affected when obstacle exists.
- Data lose rate will be affected by temperature, humidity and co-channel interference.
- The ground will absorb and reflect wireless radio wave, so the performance will be poor when testing near ground.
- Sea water has great ability in absorbing wireless radio wave, so performance will be poor when testing near the sea.
- The signal will be affected when the antenna is near metal object or put in a metal case.
- Power register was set incorrectly, air data rate is set as too high (the higher the air data rate, the shorter the distance).
- The power supply low voltage under room temperature is lower than 2.5V, the lower the voltage, the lower the transmitting power.
- Due to antenna quality or poor matching between antenna and module.

10.2 Module is easy to damage

- Please check the power supply source, ensure it is 2.0V~3.6V, voltage higher than 3.6V will damage the module.
- Please check the stability of power source, the voltage cannot fluctuate too much.
- Please make sure antistatic measure are taken when installing and using, high frequency devices have electrostatic susceptibility.
- Please ensure the humidity is within limited range, some parts are sensitive to humidity.
- Please avoid using modules under too high or too low temperature.

10.3 Bit error rate is too high

- There are co-channel signal interference nearby, please be away from interference sources or modify frequency and channel to avoid interference.
- Poor power supply may cause messy code. Make sure that the power supply is reliable
- The extension line and feeder quality are poor or too long, so the bit error rate is high.

11. Production Guidance

11.1 Reflow soldering temperature

Profile Feature	Sn-Pb Assembly	Pb-Free Assembly
Solder Paste	Sn63/Pb37	Sn96.5/Ag3/Cu0.5
Preheat Temperature min (T _{smin})	100°C	150°C
Preheat temperature max (T _{smax})	150°C	200°C
Preheat Time (T _{smin} to T _{smax})(t _s)	60-120 sec	60-120 sec
Average ramp-up rate(T _{smax} to T _p)	3°C/second max	3°C/second max
Liquidous Temperature (T _L)	183°C	217°C
Time (t _L) Maintained Above (T _L)	60-90 sec	30-90 sec
Peak temperature (T _p)	220-235°C	230-250°C
Average ramp-down rate (T _p to T _{smax})	6°C/second max	6°C/second max
Time 25°C to peak temperature	6 minutes max	8 minutes max

11.2 Reflow soldering curve

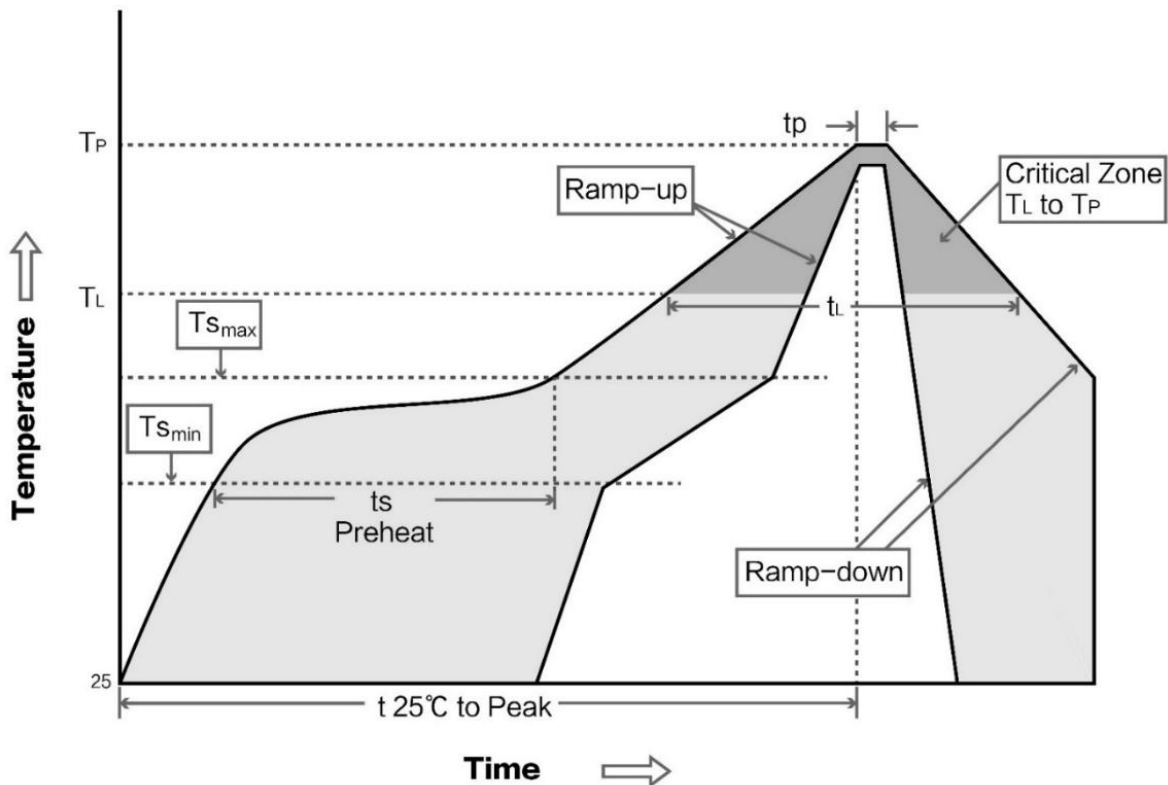

12. Related product

Model NO.	RF IC	Frequency Hz	TX POWER dBm	Interface	Protocol BLE	Size mm	Antenna	Function
E72-2G4M05S1B	CC2640	2.4G	5	I/O	4.2	17.5*28.7	PCB/IPX	Hardware module, requires secondary development
E73-2G4M04S1A	nRF52810	2.4G	4	I/O	4.2/5.0	17.5*28.7	PCB/IPX	Hardware module, requires secondary development
E73-2G4M04S1B	nRF52832	2.4G	4	I/O	4.2/5.0	17.5*28.7	PCB/IPX	Hardware module, requires secondary development
E73-2G4M08S1C	nRF52840	2.4G	8	I/O	4.2/5.0	13*18	PCB/IPX	Hardware module, requires secondary development
E73-2G4M04S1D	nRF51822	2.4G	4	I/O	4.2	17.5*28.7	PCB/IPX	Hardware module, requires secondary development
E104-BT01	CC2541	2.4G	0	I/O	4.0	14*22	PCB	Hardware module, requires secondary development
E104-BT02	DA14580	2.4G	0	TTL	4.2	14*22	PCB	Ultra-low power High speed, sniff
E72-2G4M04S2B	CC2640	2.4G	2	TTL	4.2	14*23	PCB/IPX	Built-in ARM dual core Multiple role
E104-2G4U04A	CC2540	2.4G	0	USB	4.0	18*59	PCB	Dongle Protocol Analyzer
E104-BT5010A	nRF52810	2.4G	0	UART	5.0	11.5 * 16	ceramic antenna	Low power, transparent transmission

13. Package for bulk order

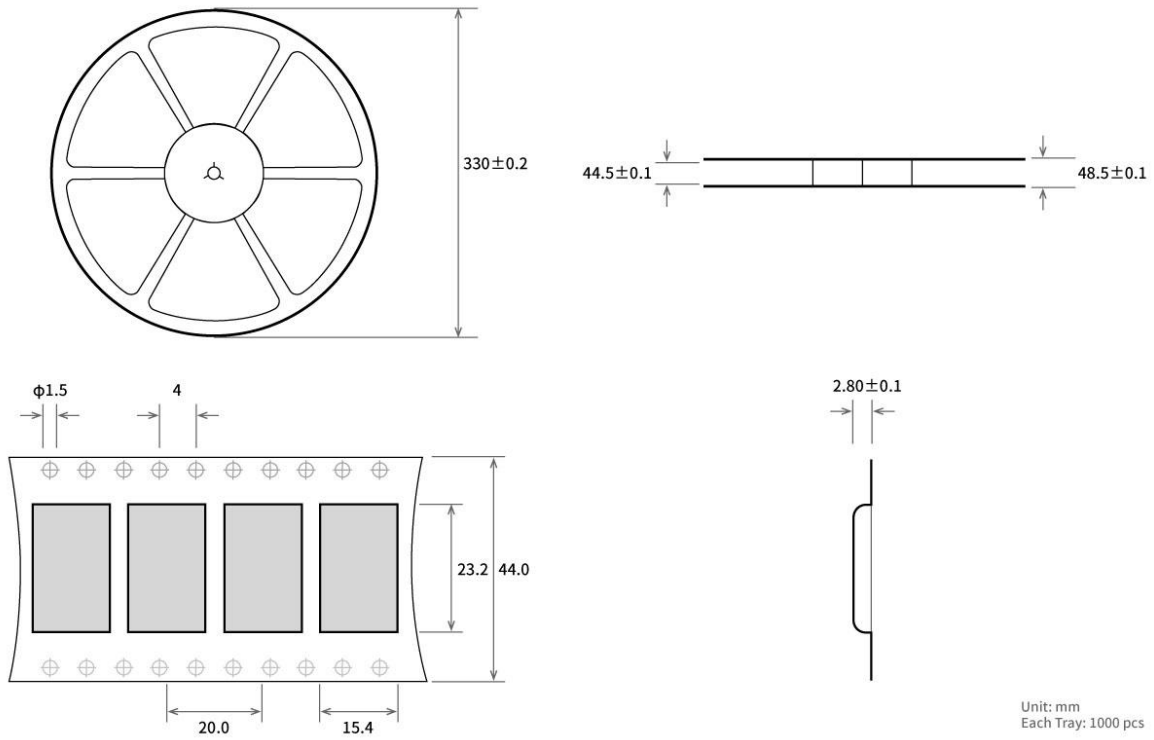

Reversion History

Version	Edit date	Description	Issued by
1.0	2019-5-9	Initial version	huaa
1.1	2019-7-30	Format modification	Lyl
1.3	2019-11-20	Product upgrade	Ren
1.4	2020-1-4	Content modification (recommended wiring diagram)	Linson
1.5	2020-04-09		Ren
1.9	2022-08-31	Error correction	Bin

About Us



Technical support: support@cdebyte.com;

Documents and RF Setting download link: www.cdebyte.com

Tel: +86-28-61399028 Ext. 812

Fax: 028-64146160

Web: www.cdebyte.com

Address: B5 Mould Park, 199# Xiqu Ave, High-tech District, Sichuan, China

 **Chengdu Ebyte Electronic Technology Co.,Ltd.**