

# G539B-2\$;G539G-2\$

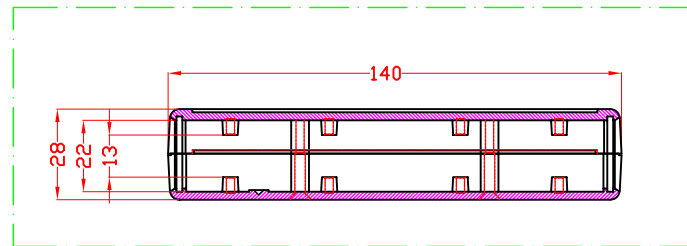
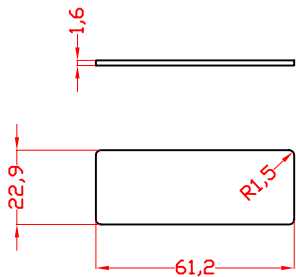
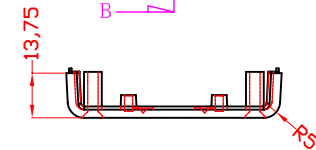
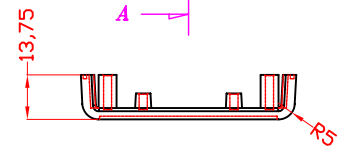
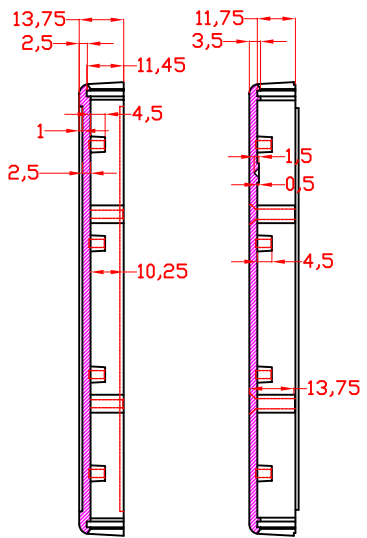
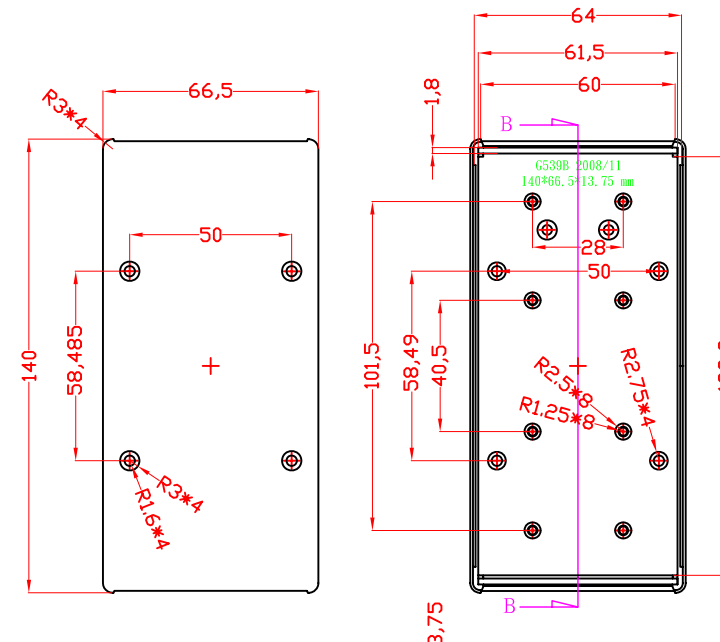
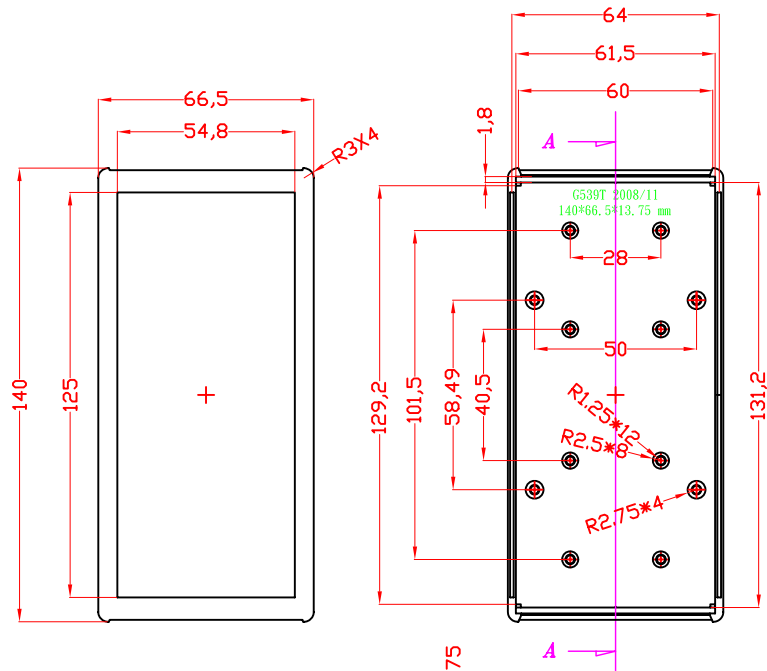

According to ISO 2768-m	
Measuring DIM.=L	Tolerance
0.5 < L ≤ 3.0 mm	±0.1 mm
3.0 < L ≤ 6.0 mm	±0.1 mm
6.0 < L ≤ 30.0 mm	±0.2 mm
30.0 < L ≤ 120.0 mm	±0.3 mm
120.0 < L ≤ 400.0 mm	±0.5 mm
400.0 < L ≤ 1000.0 mm	±0.8 mm

ITEM NO	DESCRIPTION
G539B-2\$	BLACK(G539T+G539B)*1+BLACK(PANEL-"\$")*2+M3*21 mm BLACK SCREWS *4
G539G-2\$	GRAY(G539T+G539B)*1+GRAY(PANEL-"\$")*2+M3*21 mm BLACK SCREWS *4

宜又實業有限公司  
GAINTA INDUSTRIES LTD.

設計 DES'D BY  
繪圖 DRA'D BY  
核圖 CHK'D BY

JACKY

比例 SCALE

日期 DATE

2009/1/7

材質 MATE.

ABS

圖名 TITLE:

G539B-2\$;G539G-2\$

圖號 DWG NO.:

圖號 REVISID

說明 DESCRIPTION

A