

## Bipolar, Latching, or Unipolar Digital Hall-effect Sensor ICs: SS400 Series, SS500 Series

**32320997**  
Issue A

Datasheet

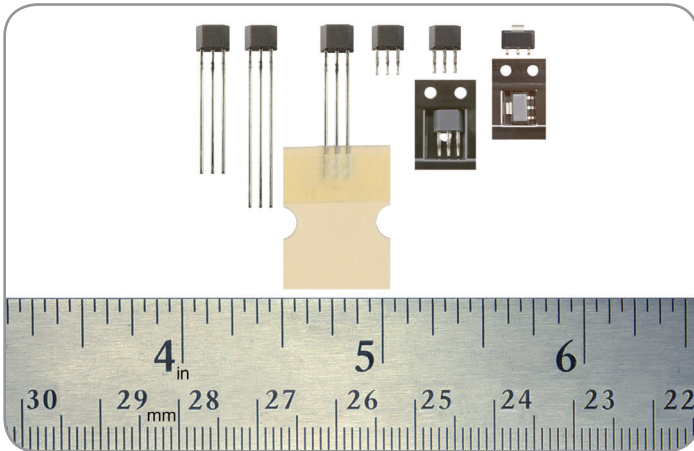

### DESCRIPTION

The SS400 Series and SS500 Series are small, versatile, digital Hall-effect devices that are operated by the magnetic field from a permanent magnet or an electromagnet. They are designed to respond to alternating North and South poles, or to a South pole only. They are available in bipolar, latching or unipolar magnetics. On-board regulation provides stable operation over a 3.8 Vdc to 30 Vdc supply voltage range. These sensors are capable of continuous 20 mA sinking output and may be cycled as high as 50 mA max. The 3.8 V capability allows for use in many potential low voltage applications. The digital, open collector sinking-type output is easily interfaced with a wide variety of electronic circuits. To provide reliable products and consistent quality, the SS400 Series products are tested at both 25 °C [75 °F] and 125 °C [257 °F]. All catalog listings in the SS400 Series are qualified for operation up to 150 °C [302 °F].

For design flexibility, these product are available in the following package styles:

- **SS400 Series:**
  - **SS4XX:** 14,5 mm [0.57 in] straight standard leads, bulk pack, 1000 units/bag
  - **SS4XX-L:** 18,7 mm [0.74 in] straight long leads, bulk pack, 1000 units/bag
  - **SS4XX-T3:** 14,5 mm [0.57 in] straight standard leads, ammpack tape-in-box, 5000 units/box
  - **SS4XX-R:** 3,30 [0.130 in] straight reduced leads, bulk pack, 1000 units/bag
  - **SS4XX-SP:** 3,18 [0.125 in] surface mount, pocket tape and reel, 1000 units/reel
- **SS500 Series:** SOT-89B, pocket tape and reel, 1000 units/reel

### FEATURES

- Quad Hall IC design minimizes mechanical stress effects
- Temperature-compensated magnetics help provide stable operation over a wide temperature range of -40 °C to 150 °C [-40 °F to 302 °F] (SS400 Series) and -50 °C to 150 °C [-58 °F to 320 °F] (SS500 Series)
- Broad inclusive supply voltage capability from 3.8 Vdc to 30 Vdc for application flexibility
- Digital, open collector sinking output for easy interfacing with a variety of common electronic circuits
- High sensitivity versions available for potential applications requiring high accuracy or wide gaps
- Bipolar, latching or unipolar magnetics

### POTENTIAL APPLICATIONS

- Industrial: Speed and RPM (revolutions per minute) sensing, tachometer, counter pickup, flow-rate sensing, brushless dc (direct current) motor commutation, motor and fan control, robotics control
- Transportation: Speed and RPM (revolutions per minute) sensing, tachometer, counter pickup, motor and fan control, electric window lift, convertible roof position
- Medical: Motor assemblies, medication dispensing control

### PORTFOLIO

Other bipolar, latching and unipolar digital Hall-effect sensor ICs include:

- SS360NT, SS360ST, SS360ST-10K, SS460S, SS460S-T2
- VF360NT, VF360ST, VF460S
- SS361RT, SS461R
- SS361CT, SS461C
- SS340RT, SS440R Series
- SS360PT, SS460P, SS460P-T2
- SS311PT, SS411P

# Bipolar, Latching, or Unipolar Digital Hall-effect Sensor ICs:

## SS400 Series, SS500 Series

**Table 1. Electrical and Environmental Specifications (Applies to both SS400 series and 500 Series, unless otherwise noted.)**

Characteristic	Symbol	Condition	Min.	Typ.	Max.	Unit
Supply voltage <sup>1</sup>	$V_s$	—	3.8	—	30	Vdc
Rated sinking current ( $I_{sink}$ )	$I_{sink}$	—	—	20	—	mA
Current consumption:						
On:						
SS400 Series		$V_s = 30 \text{ Vdc}$ , $I_{sink} = 20 \text{ mA}$ , $-40 \text{ }^\circ\text{C} < T < 150 \text{ }^\circ\text{C}$ , B > operate max.	—	—	10.0	mA
SS500 Series	—	$V_s = 30 \text{ Vdc}$ , $-40 \text{ }^\circ\text{C} < T < 150 \text{ }^\circ\text{C}$ , B > operate max.	—	—	10.0	
Off:						
SS400 Series		$V_s = 30 \text{ Vdc}$ , $I_{sink} = 20 \text{ mA}$ , $-40 \text{ }^\circ\text{C} < T < 150 \text{ }^\circ\text{C}$ , B > operate max.	—	—	9.0	
SS500 Series		$V_s = 30 \text{ Vdc}$ , $I_{sink} = 20 \text{ mA}$ , $-40 \text{ }^\circ\text{C} < T < 150 \text{ }^\circ\text{C}$ , B > release min.	—	—	10.0	
Vsat:						
SS400 Series	—	$V_s = 3.8 \text{ Vdc}$ , $I_{sink} = 20 \text{ mA}$ , B > operate max.	—	—	0.4	V
SS500 Series		$V_s = 3.8 \text{ Vdc}$ , B > operate max.	—	—	0.4	
Output leakage current:						
SS400 Series	—	$V_s = 24 \text{ V}$ , $V_{out} = 30 \text{ V}$ , B < release min.	—	—	0.4	uA
SS500 Series		—	—	—	10.0	
Output switching time:						
rise	—	$V_s = 12 \text{ V}$ , $R_L = 1.6 \text{ k}\Omega$ , $C_L = 20 \text{ pF}$ , $T = 25 \text{ }^\circ\text{C}$ [77 °F]	—	—	1.5	μs
fall		$V_s = 12 \text{ V}$ , $R_L = 1.6 \text{ k}\Omega$ , $C_L = 20 \text{ pF}$ , $T = 25 \text{ }^\circ\text{C}$ [77 °F]	—	—	1.5	
Operating temperature:						
SS400 Series	T	—	-40 [-40]	—	150 [302]	°C [°F]
SS500 Series		—	-50 [-58]	—	150 [302]	
Storage temperature:						
SS400 Series	Ts	—	-50 [-58]	—	150 [302]	°C [°F]
SS500 Series		—	-65 [-85]	—	150 [302]	
Soldering temp. and time:						
SS400 Series	—	wave soldering process: 250 °C to 260 °C [482 °F to 500 °F] for 3 s max.				
SS500 Series		infrared reflow process: peak temperature 245 °C [473 °F] for 10 s max.				

<sup>1</sup>For supply voltages above 24 Vdc, a capacitor may be needed between the output and supply pins to ensure proper operation.

### NOTICE

These Hall-effect sensor ICs may have an initial output in either the ON or OFF state if powered up with an applied magnetic field in the differential zone (applied magnetic field >Brp and <Bop). Honeywell recommends allowing 10 μs after supply voltage has reached 5 V for the output voltage to stabilize.

### NOTICE

The magnetic field strength (Gauss) required to cause the switch to change state (operate and release) will be as specified in the magnetic characteristics. To test the switch against the specified limits, the switch must be placed in a uniform magnetic field.



# Bipolar, Latching, or Unipolar Digital Hall-effect Sensor ICs:

## SS400 Series, SS500 Series

**Table 2. Absolute Maximum Specifications**

Characteristic	Symbol	Min.	Typ.	Max.	Unit
Supply voltage	$V_s$	-1	—	30	V
Applied output voltage:					
SS400 Series	$V_{out}$	-0.5	—	30	V
SS500 Series (off)		—	—	30	
Output current:					
$V_s = -1$ Vdc to 24 Vdc		—	—	50	
$V_s = 24$ Vdc to 25 Vdc		—	—	37	
$V_s = 25$ Vdc to 26 Vdc		—	—	33	
$V_s = 26$ Vdc to 27 Vdc	$I_{sink}$	—	—	28	mA
$V_s = 27$ Vdc to 28 Vdc		—	—	24	
$V_s = 28$ Vdc to 29 Vdc		—	—	19	
$V_s = 29$ Vdc to 30 Vdc		—	—	15	
Magnetic flux	—	—	—	no limit	Gauss

### NOTICE

Absolute maximum ratings are the extreme limits the device will momentarily withstand without damage to the device. Electrical and mechanical characteristics are not guaranteed if the rated voltage and/or currents are exceeded, nor will the device necessarily operate at absolute maximum ratings.

**Figure 1. Circuit Diagram**

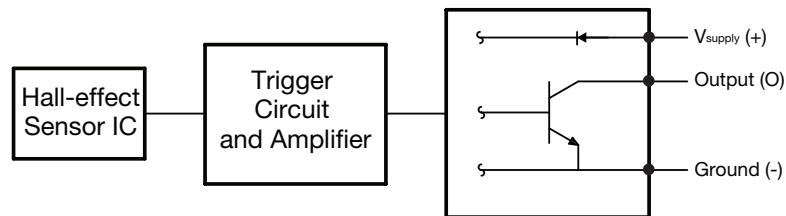

**Figure 2. Magnetic Activation**

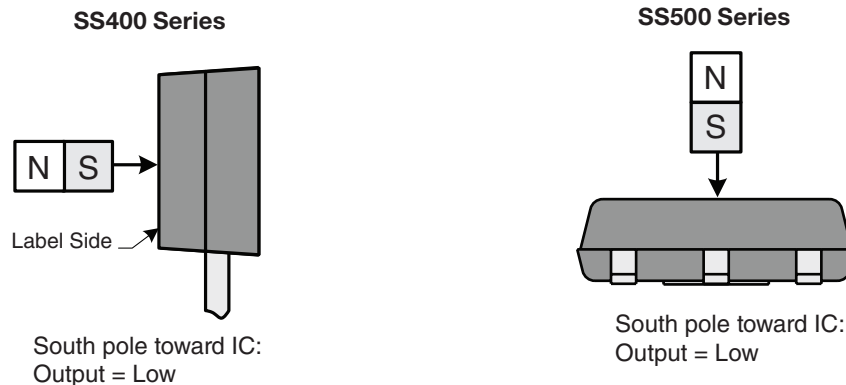

# Bipolar, Latching, or Unipolar Digital Hall-effect Sensor ICs:

SS400 Series, SS500 Series

Table 3. Magnetic Specifications

Temperature	Operating Characteristic	Magnetic Characteristic (Gauss)												
		Bipolar				Unipolar				Latching				
		SS411	SS511AT	SS413	SS513AT	SS441	SS541AT	SS443	SS543AT	SS449	SS549AT	SS461	SS561AT	SS466
-40 °C [-40 °F]	<b>operate:</b> minimum	NS		NS	50	110	285		5	—	100			
	maximum	70		140	135	215	435		110	100	200			
	<b>release:</b> minimum	-70		-140	20	80	210		-110	-100	-200			
	maximum	NS		NS	120	190	360		-5	-5	-100			
	<b>differential (min.)</b>	15		20	15	25	30		50	50	200			
0 °C [0 °F]	<b>operate:</b> minimum	NS		NS	53	110	305		5		100			
	maximum	65		140	117	190	400		90		185			
	<b>release:</b> minimum	-65		-140	20	80	230		-90		-185			
	maximum	NS		NS	99	165	325		-5		-100			
	<b>differential (min.)</b>	15		20	15	25	30		50		200			
25 °C [77 °F]	<b>operate:</b> minimum	NS		NS	55	110	310		10		100			
	maximum	60		140	115	180	390		85		180			
	<b>release:</b> minimum	-60		-140	20	75	235		-85		-180			
	maximum	NS		NS	95	155	315		-10		-100			
	<b>differential (min.)</b>	15		20	20	25	30		50		200			
85 °C [185 °F]	<b>operate:</b> minimum	NS		NS	45	90	290	—	10		95			
	maximum	60		140	120	180	400	400	85		180			
	<b>release:</b> minimum	-60		-140	15	70	215	315	-85		-180			
	maximum	NS		NS	105	165	325	—	-10		-95			
	<b>differential (min.)</b>	12		20	15	15	30	30	50		190			
125 °C [257 °F]	<b>operate:</b> minimum	NS		NS	40	80	270	290	5		80			
	maximum	65		140	123	190	410	400	100		180			
	<b>release:</b> minimum	-65		-140	15	60	200	215	-100		-180			
	maximum	NS		NS	115	180	340	325	-5		-80			
	<b>differential (min.)</b>	12		20	8	10	30	30	50		160			
150 °C [302 °F]	<b>operate:</b> minimum	NS		NS	35	65	260		5		70			
	maximum	70		140	125	200	420		110		185			
	<b>release:</b> minimum	-70		-140	10	55	185		-110		-185			
	maximum	NS		NS	120	195	345		-5		-70			
	<b>differential (min.)</b>	10		20	5	5	30		50		140			

# Bipolar, Latching, or Unipolar Digital Hall-effect Sensor ICs:

## SS400 Series, SS500 Series

Figure 3. Operate and Release Point Performance Graphics

SS411/SS511AT

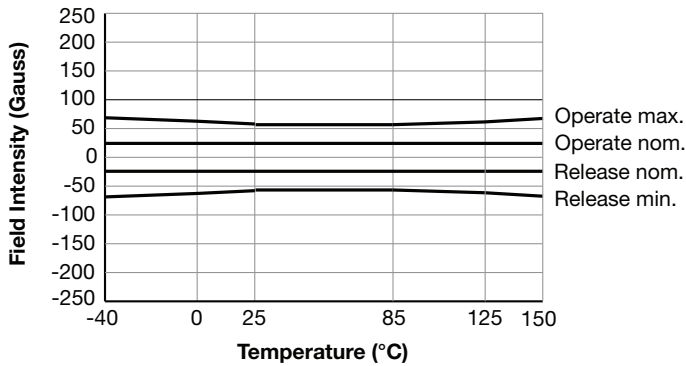

SS413/SS513AT

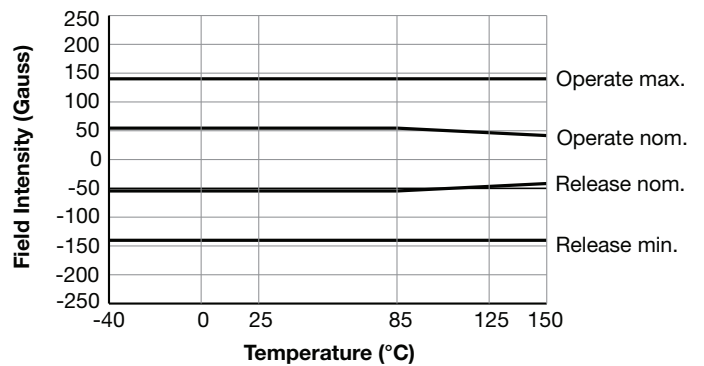

SS441/SS541AT

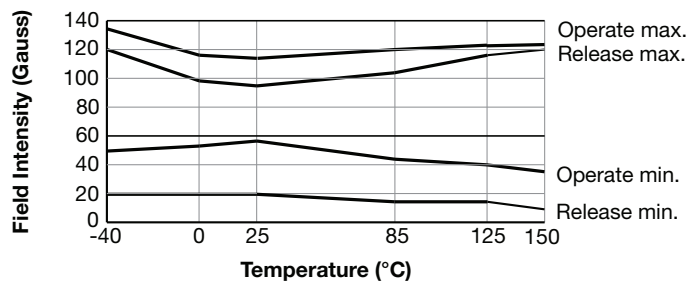

SS443/SS443AT

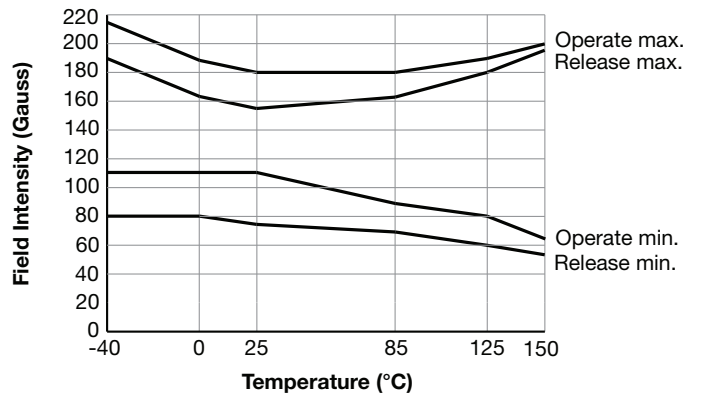

SS4449/SS549AT

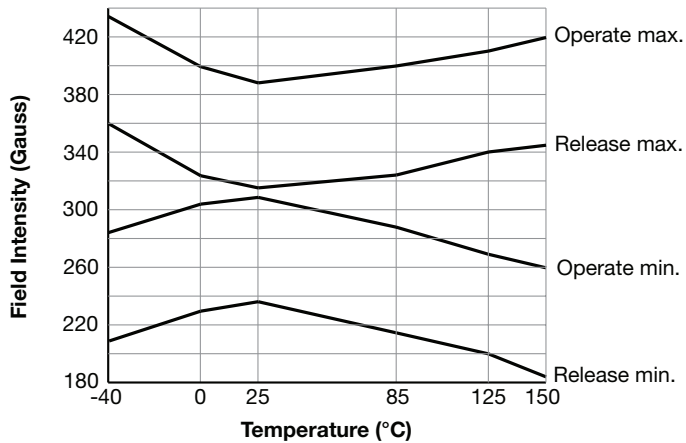

SS461/SS561AT

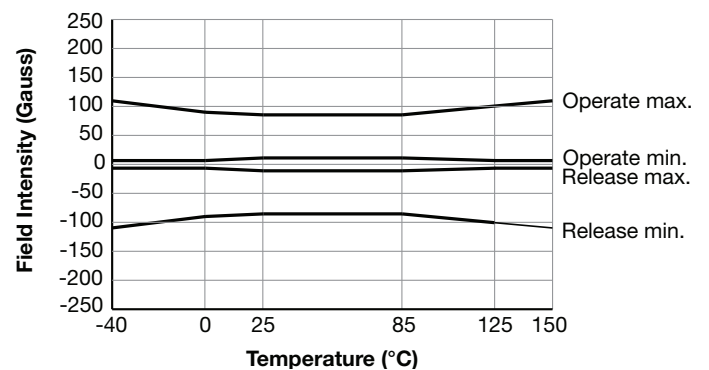

SS466/SS566AT

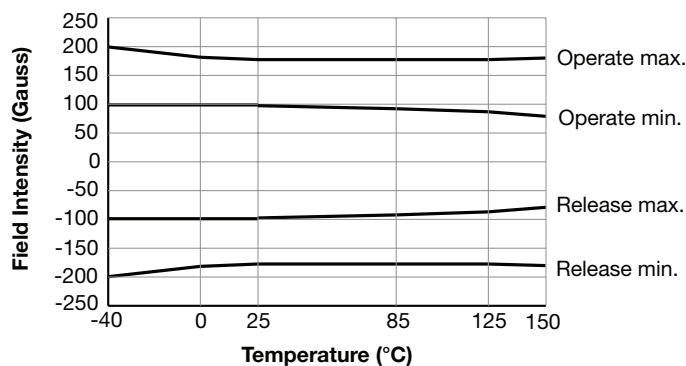





# Bipolar, Latching, or Unipolar Digital Hall-effect Sensor ICs:

## SS400 Series, SS500 Series

Figure 6. SS500 Series Mounting and Dimensional Drawings (For reference only: mm/[in].)

### SOT-89B Sensor IC, Pocket Tape and Reel

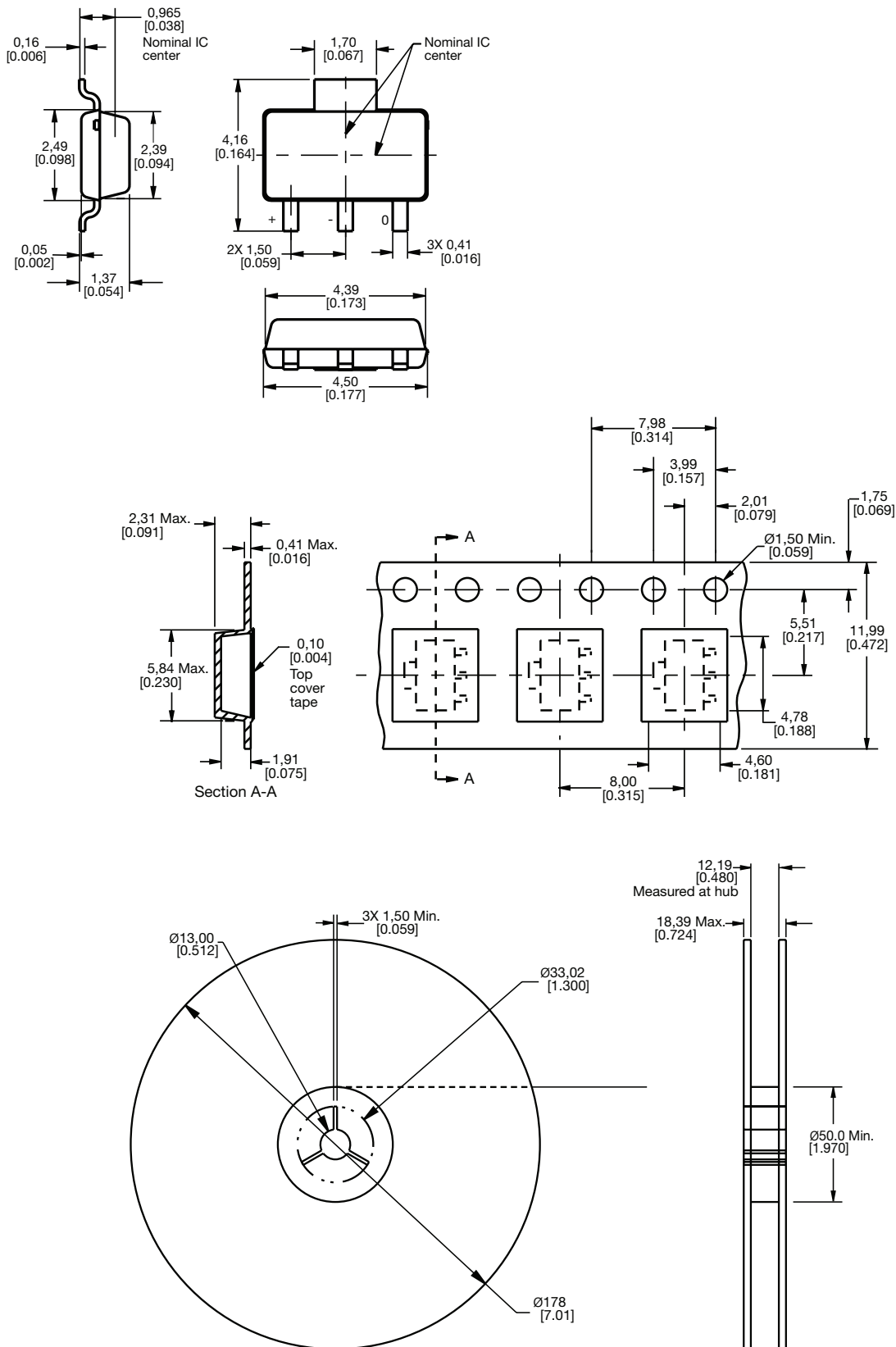







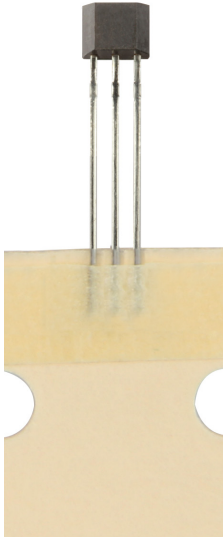

# Bipolar, Latching, or Unipolar Digital Hall-effect Sensor ICs:

## SS400 Series, SS500 Series

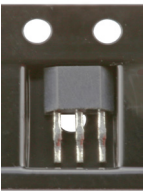
**Table 4. Order Guide for the SS400 Series (Flat TO-92-Style)**

Catalog Listing	Description	SS4XX	SS4XX-L	SS4XX-T3
<b>SS4XX: 14,5 mm [0.57 in] straight standard leads, bulk pack, 1000 units/bag</b>				
SS411A	Bipolar			
SS413A	Bipolar			
SS441A	Unipolar			
SS443A	Unipolar			
SS449A	Unipolar			
SS461A	Latching			
SS466A	Latching			
<b>SS4XX-L: 18,7 mm [0.74 in] straight long leads, bulk pack, 1000 units/bag</b>				
SS461A-L	Latching			
<b>SS4XX-T3: 14,5 mm [0.57 in] straight standard leads, ammpack tape-in-box, 5000 units/box</b>				
SS443A-T3	Unipolar			
SS449A-T3	Unipolar			
<b>SS4XX-R: 3,30 [0.130 in] straight reduced leads, bulk pack, 1000 units/bag</b>				
SS411A-R	Bipolar			
<b>SS4XX-S: 3,18 [0.125 in] surface mount, bulk pack</b>				
SS411A-S	Bipolar			
SS443A-S	Unipolar			
SS449A-S	Unipolar			
<b>SS4XX-SP: 3,18 [0.125 in] surface mount, pocket tape and reel, 1000 units/reel</b>				
SS443A-SP	Unipolar			
SS449A-SP	Unipolar			

**Table 5. Order Guide for the SS500 Series (SOT-89B, Pocket Tape and Reel, 1000 Units/Reel)**

Catalog Listing	Description	
SS511AT	Bipolar	
SS513AT	Bipolar	
SS541AT	Unipolar	
SS543AT	Unipolar	
SS549AT	Unipolar	
SS561AT	Latching	
SS566AT	Latching	

## ADDITIONAL INFORMATION

The following associated literature is available on the Honeywell web site at [sensing.honeywell.com](http://sensing.honeywell.com):

- Product Line Guide
- Product Range Guide
- Selection Guides
- Application-specific Information

### **⚠ WARNING** **PERSONAL INJURY**

DO NOT USE these products as safety or emergency stop devices or in any other application where failure of the product could result in personal injury.

**Failure to comply with these instructions could result in death or serious injury.**

### **⚠ WARNING** **MISUSE OF DOCUMENTATION**

- The information presented in this datasheet is for reference only. Do not use this document as a product installation guide.
- Complete installation, operation, and maintenance information is provided in the instructions supplied with each product.

**Failure to comply with these instructions could result in death or serious injury.**

## Find out more

Honeywell serves its customers through a worldwide network of sales offices, representatives and distributors.

For application assistance, current specifications, pricing or name of the nearest Authorized Distributor, contact your local sales office.

To learn more about Honeywell Sensing and Productivity Solutions' products, call **+1-815-235-6847** or **1-800-537-6945**, visit **[sensing.honeywell.com](http://sensing.honeywell.com)**, or e-mail inquiries to **[info.sc@honeywell.com](mailto:info.sc@honeywell.com)**

## Honeywell Sensing and Productivity Solutions

9680 Old Bailes Road  
Fort Mill, SC 29707  
[honeywell.com](http://honeywell.com)

32320997-A-EN IL50 GLO  
June 2016  
© 2016 Honeywell International Inc. All rights reserved.

## Warranty/Remedy

Honeywell warrants goods of its manufacture as being free of defective materials and faulty workmanship. Honeywell's standard product warranty applies unless agreed to otherwise by Honeywell in writing; please refer to your order acknowledgement or consult your local sales office for specific warranty details. If warranted goods are returned to Honeywell during the period of coverage, Honeywell will repair or replace, at its option, without charge those items it finds defective.

**The foregoing is buyer's sole remedy and is in lieu of all other warranties, expressed or implied, including those of merchantability and fitness for a particular purpose. In no event shall Honeywell be liable for consequential, special, or indirect damages.**

While Honeywell may provide application assistance personally, through our literature and the Honeywell web site, it is up to the customer to determine the suitability of the product in the application.

Specifications may change without notice. The information we supply is believed to be accurate and reliable as of this printing. However, we assume no responsibility for its use.

# Honeywell