

# HF157F

# MINIATURE INTERMEDIATE POWER RELAY



File No.:E133481



File No.:R50403813



File No.:CQC18002189443

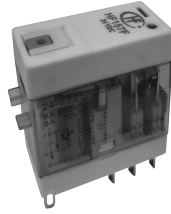

## Features

- High capacity ( 2 pole: 10 A)
- Various types available
- 2 pole configurations
- 5kV dielectric strength  
(between coil and contacts)
- Sockets available
- Environmental friendly product (RoHS compliant)
- Outline Dimensions: without button:29.0mm x13.0mm x29.0mm  
with button: 29.0mm x13.0mm x34.5mm

## CONTACT DATA

|                                  |  |
|----------------------------------|--|
| Contact arrangement              | 2C   |
| Contact resistance <sup>1)</sup> | 100mΩ (at 1A 24VDC)  |
| Contact material                 | AgSnO <sub>2</sub> In <sub>2</sub> O <sub>3</sub>  |
| Contact rating(Res. load)        | 2Z:8A 250VAC/30VDC   |
| Max. switching voltage           | 250VAC / 30VDC   |
| Max. switching current           | 2Z:10A   |
| Max. switching power             | 2Z:2500VA / 300W   |
| Mechanical endurance             | AC:3 x 10 <sup>7</sup> OPS DC:5 x 10 <sup>7</sup> OPS  |
| Electrical endurance             | 1 x 10 <sup>5</sup> OPS<br>(2Z:8A 250VAC/30VDC,Resistive load,<br>Room temp., 1s on 9s off,NO or NC) |

Notes: 1) The data shown above are initial values.

## CHARACTERISTICS

|                               |   |                     |
|-------------------------------|---|---------------------|
| Insulation resistance         | 1000MΩ (at 500VDC)  |                     |
| Dielectric strength           | Between coil & contacts   | 5000VAC 1min        |
|                               | Between open contacts   | 1000VAC 1min        |
|                               | Between contact sets  | 3000VAC 1min        |
| Operate time (at nomi. volt.) | 15ms max.   |                     |
| Release time (at nomi. volt.) | 20ms max.<br>(AC、With diode or<br>CR circuit)                     |                     |
|                               | DC: 10ms max.   |                     |
| Shock resistance              | Functional  | 98m/s <sup>2</sup>  |
|                               | Destructive   | 980m/s <sup>2</sup> |
| Vibration resistance          | 10Hz to 55Hz 1.5mm DA   |                     |
| Humidity                      | 5% to 85% RH  |                     |
| Ambient temperature           | -40°C to 70°C   |                     |
| Termination                   | Plug-in   |                     |
| Unit weight                   | Approx. 23.5g(button type)<br>Approx.22g<br>(without button type) |                     |
| Construction                  | Dust protected  |                     |

Notes: 1) The data shown above are initial values.

## COIL

|            |                      |
|------------|----------------------|
| Coil power | AC: 0.53W; DC: 0.9VA |
|------------|----------------------|

## COIL DATA

at 23°C

| Nominal Voltage VDC | Pick-up Voltage VDC <sup>1)</sup> | Drop-out Voltage VDC <sup>1)</sup> | Max. Allowable Voltage VDC <sup>2)</sup> | Coil Resistance Ω |
|---------------------|-----------------------------------|------------------------------------|--|-------------------|
| 5                   | 3.5                               | 0.5                                | 5.5                                      | 47.2 x (1±10%)    |
| 6                   | 4.2                               | 0.6                                | 6.6                                      | 67.9 x (1±10%)    |
| 12                  | 8.4                               | 1.2                                | 13.2                                     | 271 x (1±10%)     |
| 24                  | 16.8                              | 2.4                                | 26.4                                     | 1080 x (1±10%)    |
| 36                  | 25.2                              | 3.6                                | 39.6                                     | 2445 x (1±10%)    |
| 48                  | 33.6                              | 4.8                                | 52.8                                     | 4340 x (1±10%)    |
| 60                  | 42                                | 6                                  | 66                                       | 6792 x (1±10%)    |
| 100~110             | 77                                | 11                                 | 110~121                                  | 18870 x (1±10%)   |

| Nominal Voltage VAC | Pick-up Voltage VAC <sup>1)</sup> | Drop-out Voltage VAC <sup>1)</sup> | Max. Allowable Voltage VAC <sup>2)</sup> | Coil Resistance Ω |
|---------------------|-----------------------------------|------------------------------------|--|-------------------|
| 6                   | 4.8                               | 1.8                                | 6.6                                      | 16 x (1±10%)      |
| 12                  | 9.6                               | 3.6                                | 13.2                                     | 62.5 x (1±10%)    |
| 24                  | 19.2                              | 7.2                                | 26.4                                     | 243x (1±10%)      |
| 48                  | 38.4                              | 14.4                               | 52.8                                     | 1085 x (1±10%)    |
| 60                  | 48                                | 18                                 | 66                                       | 1750 x (1±10%)    |
| 110                 | 88                                | 33                                 | 121                                      | 5270x (1±10%)     |
| 115                 | 92                                | 34.5                               | 126.5                                    | 6030 x (1±10%)    |
| 120                 | 96                                | 36                                 | 132                                      | 6400 x (1±10%)    |
| 220                 | 176                               | 66                                 | 242                                      | 21530 x (1±10%)   |
| 230                 | 184                               | 69                                 | 253                                      | 24100 x (1±10%)   |
| 240                 | 192                               | 72                                 | 264                                      | 25570 x (1±10%)   |

Notes: 1) The data shown above are initial values.

2) Maximum voltage refers to the maximum voltage which relay coil could endure in a short period of time.



HONGFA RELAY

ISO9001, ISO/TS16949, ISO14001, OHSAS18001, IECQ QC 080000 CERTIFIED

2018 Rev. 1.00

## SAFETY APPROVAL RATINGS

|        |    |                                      |
|--------|----|--------------------------------------|
| UL&CUL | 2C | 8A 250VAC/30VDC Resistive load 70°C  |
|        |    | 10A 250VAC/30VDC Resistive load 70°C |
| TÜV    | 2C | 8A 250VAC/30VDC Resistive load 70°C  |
|        |    | 10A 250VAC/30VDC Resistive load 70°C |

**Notes:** Only some typical ratings are listed above. If more details are required, please contact us.

## ORDERING INFORMATION

|                                     |   |         |  |                        |  |                       |  |  |  |  |  |
|-------------------------------------|---|---------|--|------------------------|--|-----------------------|--|--|--|--|--|
| Type                                | HF157F / A 24 -2Z 2 5 F D 2 (XXX)                   |         |  |                        |  |                       |  |  |  |  |  |
| Coil voltage form                   | A: AC   | Nil: DC |  |                        |  |                       |  |  |  |  |  |
| Coil voltage                        | AC: 5 to 110VDC<br>DC: 6 to 240VAC                  |         |  |                        |  |                       |  |  |  |  |  |
| Contact arrangement                 | 2Z: 2 Form C  |         |  |                        |  |                       |  |  |  |  |  |
| Termination                         | 2: QC   |         |  |                        |  |                       |  |  |  |  |  |
| Contact material                    | 5:AgSnO <sub>2</sub> In <sub>2</sub> O <sub>3</sub> |         |  |                        |  |                       |  |  |  |  |  |
| Insulation standard                 | F: Class F  |         |  |                        |  |                       |  |  |  |  |  |
| Component code <sup>1)</sup>        | D: With LED   |         |  | DJ1: With diode(1:"+") |  |                       |  |  |  |  |  |
|                                     | DJ: With LED and diode(1:"-")                       |         |  | DE: LED、CR circuit     |  |                       |  |  |  |  |  |
| Mounting termination                | 1:button type                                       |         |  |                        |  | 2:Without button type |  |  |  |  |  |
| Customer special code <sup>2)</sup> | XXX: Customer special requirement                   |         |  |                        |  | Nil: Standard         |  |  |  |  |  |

**Notes:**1) Assembled component with "J"freewheel diode, applied in DC coil type, with "E" RC circuit board, applied in AC coil type.

2) The customer special requirement express as special code after evaluating by Hongfa.

Outline Dimensions

HF157F/□□□□-2Z2□F□2(□□□)

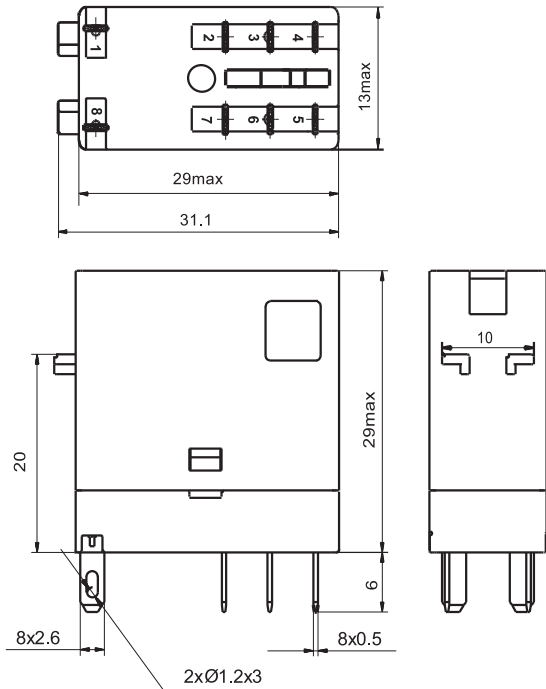

HF157F/□□□□-2Z2□F□1(□□□)

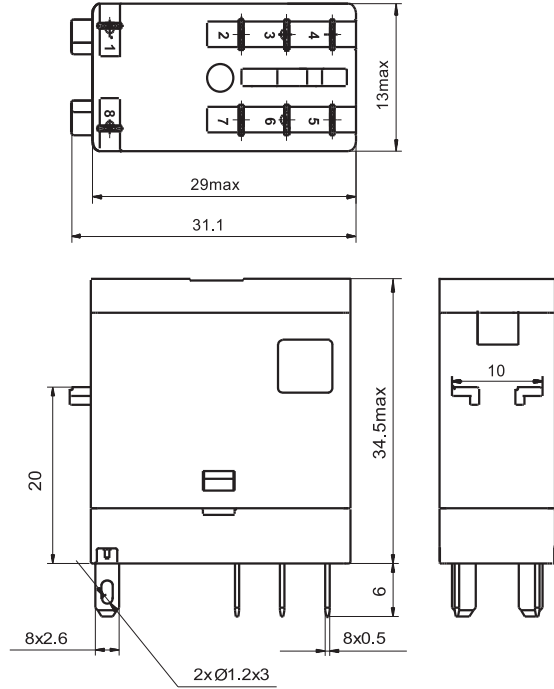

Remark: 1) In case of no tolerance shown in outline dimension: outline dimension  $\leq 1$ mm, tolerance should be  $\pm 0.2$ mm; outline dimension  $> 1$ mm and  $\leq 5$ mm, tolerance should be  $\pm 0.3$ mm; outline dimension  $> 5$ mm, tolerance should be  $\pm 0.4$ mm.  
 2) The tolerance without indicating for PCB layout is always  $\pm 0.1$ mm.

Wiring Diagram

(Bottom view)

HF157F/□□□□-2Z2□FD□(□□□)  
(With LED)

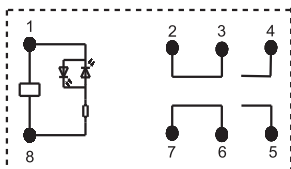

HF157F/□□□□-2Z2□FDE□(□□□)  
(With LED,CR circuit)

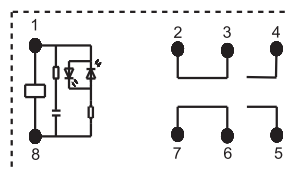

Wiring Diagram  
(Bottom view)

HF157F/□□□□-2Z2□ FDJ□ (□□□)  
(With LED, fly-wheel diode1:"-")

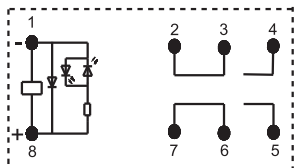

HF157F/□□□□-1Z2□ FDJ1□ (□□□)  
(With LED, fly-wheel diode1:"+")

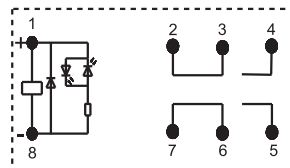

Relay Socket

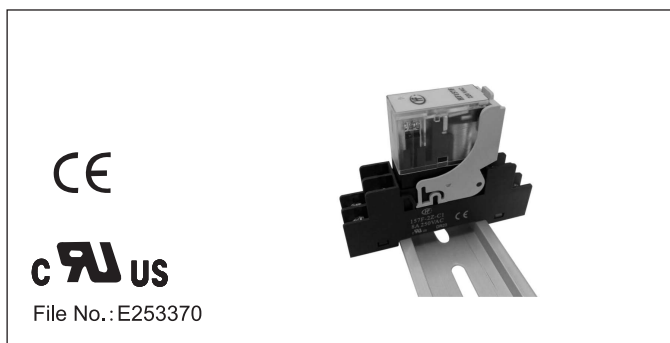

Features

- The dielectric strength can reach 4000VAC(I/O), and the insulation resistance is 1000MΩ
- Two mounting types are available: screw mounting and DIN rail mounting.
- Components available: plastic retainer(Collocation marker), metallic reainer.
- Applicable for:HF157F
- Environmental friendly product (RoHS compliant)

CHARACTERISTICS

| Type       | Nominal Voltage | Nominal Current | Ambient Temperature | Dielectric Strength min.          | Screw Torque | Wire Strip Length | Unit weight |
|------------|-----------------|-----------------|---------------------|-----------------------------------|--------------|-------------------|-------------|
| 157F-2Z-C1 | 250VAC/VDC      | 8A/10A          | -40 °C ~ 70°C       | 4000VAC (Between coil & contacts) | 1.0N·m       | 7mm               | Approx.28g  |
|            |                 |                 |                     | 1000VAC (Homopolar contacts)      |              |                   |             |
|            |                 |                 |                     | 3000VAC (Heterospolar contacts)   |              |                   |             |

## OUTLINE DIMENSIONS, WIRING DIAGRAM AND PC BOARD LAYOUT

Unit: mm

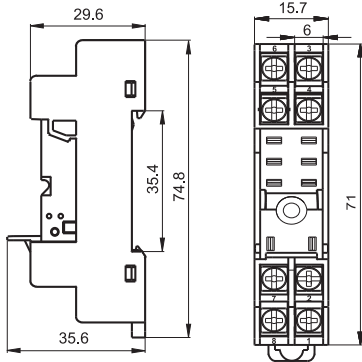
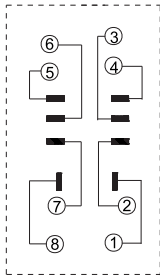
| Socket  | Outline Dimensions  | Wiring Diagram / PCB Layout  | Components Available                                  |
|---|---|--|---|
| 157F-2Z-C1<br><br>DIN rail or Screw mounting |  | <br>(Top View) | plastic retainer 157F-H1<br>metallic retainer 157F-H2 |

## DIMENSION OF RELATED COMPONENT (AVAILABLE)

Unit: mm

### Retainer

157F-H1(Plastic retainer)

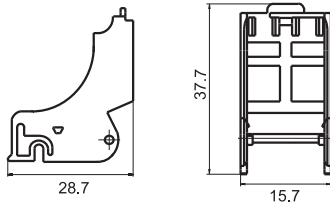

157F-H2(Plastic retainer)

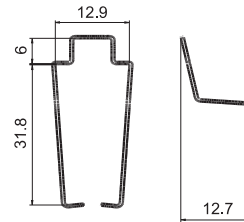

## SELECTION OF PARTS

| Type of Relay      | Mounting termination | Socket     | Retainer | Marker  | Modules |
|--------------------|----------------------|------------|----------|---------|---------|
| HF157F/□□□-2Z2□□□1 | With button          | 157F-2Z-C1 | 157F-H1  | 14FF-M1 | -       |
| HF157F/□□□-2Z2□□□2 | Without button       | 157F-2Z-C1 | 157F-H1  | 14FF-M1 | -       |
|                    |                      |            | 157F-H2  | -       |         |

### Things to be noticed when selecting sockets:

- Please choose suitable relay socket according to the actual mounting environment, relay contact poles and terminal layout. If there is any query on selection, please contact Hongfa for the technical service.
- Socket which can be mounted with markers is furnished with a marker; as for other related components, they should be selected separately. Please do give clear indication of the types of relay sockets and related components you choose while placing order.
- The above is only an example of typical socket and related component type which is suitable to HF157F relay. If you have any special requirements, please contact us.
- Main outline dimension(L, W, H)  $\geq 50$ mm, tolerance should be  $\pm 1$ mm; outline dimension  $> 20$ mm and  $< 50$ mm, tolerance should be  $\pm 0.5$ mm; outline dimension  $\leq 20$ mm, tolerance should be  $\pm 0.3$ mm.
- DIN rail mounting: recommend to use standard rail  $35 \times 7.5 \times 1$ ,  $35 \times 15 \times 1$ .

### Disclaimer

The specification is for reference only. See to "Terminology and Guidelines" for more information. Specifications subject to change without notice. We could not evaluate all the performance and all the parameters for every possible application. Thus the user should be in a right position to choose the suitable product for their own application. If there is any query, please contact Hongfa for the technical service. However, it is the user's responsibility to determine which product should be used only.

© Xiamen Hongfa Electroacoustic Co., Ltd. All rights of Hongfa are reserved.