



# HTM0802B-25W-T5P-V03

产品名称 (Product name) : Character Display Module  
型 号 (Model) : HTM0802B-25W-T5P-V03  
编 号 (Part number) : \_\_\_\_\_  
日 期 (Date) : 2025-07-01

<b>深圳市鑫洪泰电子科技有限公司</b> Shenzhen Hot Display Technology Co.,Ltd		
编制 Prepared by	审核 Checked by	核准 Approved by

编码: QR-R-011 A/0

序号:

Rev.	Descriptions	Date
00	Prelimiay Release	2007-08-29
01	Revise parameters	2025-07-01

# Table of Content

<b>1. Basic Specifications</b>	-----	<b>3</b>
1.1 Display Specifications	-----	3
1.2 Mechanical Specifications	-----	3
1.3 Circuit Diagram	-----	3
1.4 Terminal Function	-----	4
1.5 Product Outline	-----	5
1.6 Schematic Diagram	-----	6
<b>2. Absolute Maximum Ratings</b>	-----	<b>7</b>
<b>3. Electrical Characteristics</b>	-----	<b>7</b>
3.1 DC Characteristics	-----	7
3.2 LED Backlight Circuit	-----	7
3.3 AC Characteristics	-----	8
<b>4. Function specifications</b>	-----	<b>9</b>
4.1 The Parallel Interface	-----	9
4.2 Display Memory Map	-----	10
4.3 Display Commands	-----	11
4.4 Basic Operating Sequence	-----	16
<b>5. Inspection Standards</b>	-----	<b>17</b>
<b>6. Handling Precautions</b>	-----	<b>18</b>
6.1 Mounting method	-----	18
6.2 Cautions of LCD handling and cleaning	-----	18
6.3 Caution against static charge	-----	18
6.4 Packaging	-----	18
6.5 Caution for operation	-----	18
6.6 Storage	-----	18
6.7 Safety	-----	18

# 1. Basic Specifications

## 1.1 Display Specifications

- 1>LCD Display Mode : STN-Blue, Negative, Transmissive
- 2>Viewing Angle : 6H
- 3>Driving Method : 1/16 Duty, 1/5 Bias
- 4 >Backlight : White

## 1.2 Mechanical Specifications

- 1>Outline Dimension : 58.0X32.0 X 10.2mm (See attached Outline Drawing for Data)

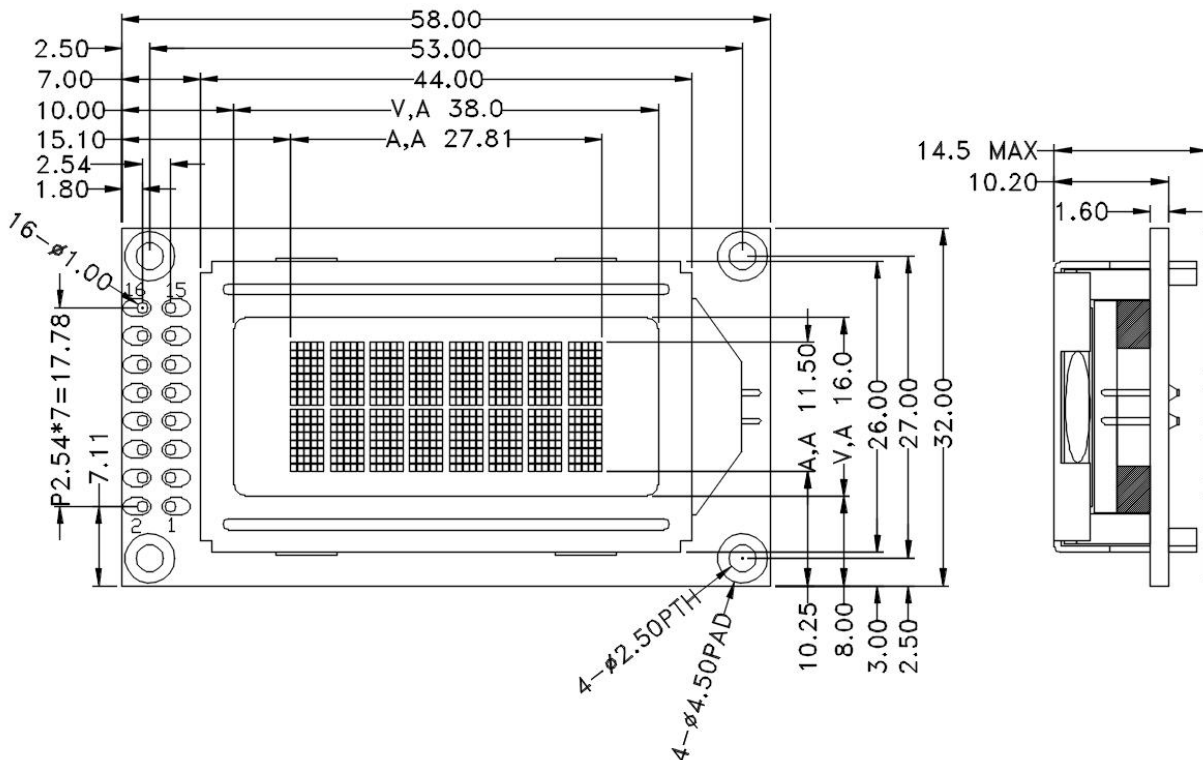

## 1.3 Circuit Diagram

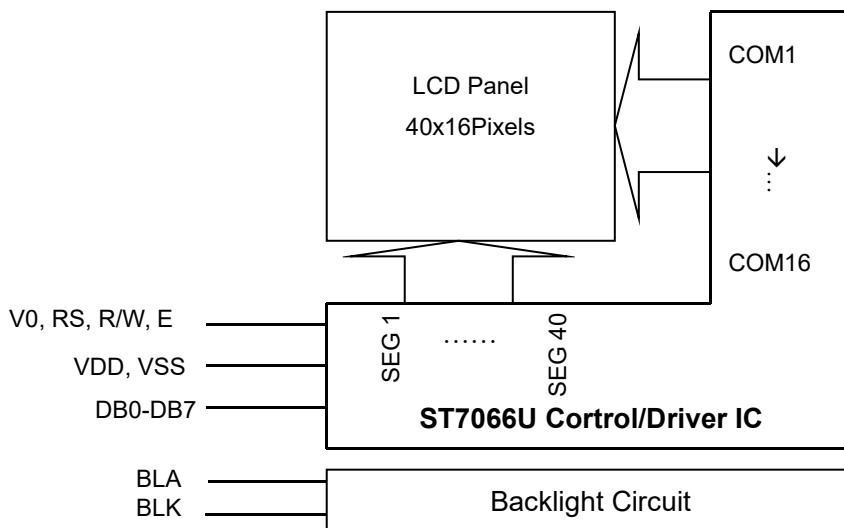

**1.4 Terminal Function**

Pin No.	Pin Name	Function
1	VSS	Power Supply, (0V)
2	VDD	Positive Power Supply (5.0V)
3	V0	LCD Contrast Reference Supply
4	RS	Select Register 0: Instruction register (for write) busy flag address Counter(for read) 1: Data register (for write and read)
5	R/W	Select read or write 0: Write 1: Read
6	E	Starts data read/write
7	DB0	Data Bus Lines
8	DB1	
9	DB2	
10	DB3	
11	DB4	
12	DB5	
13	DB6	
14	DB7	
15	BLA	Backlight Positive(5.0V)
16	BLK	Backlight Negative(VSS)

**1.4.1 Display Address**

	1	2	3	4	5	6	7	8
Line 1	80	81	82	83	84	85	86	87
Line 2	C0	C1	C2	C3	C4	C5	C6	C7

1.5 Product Outline

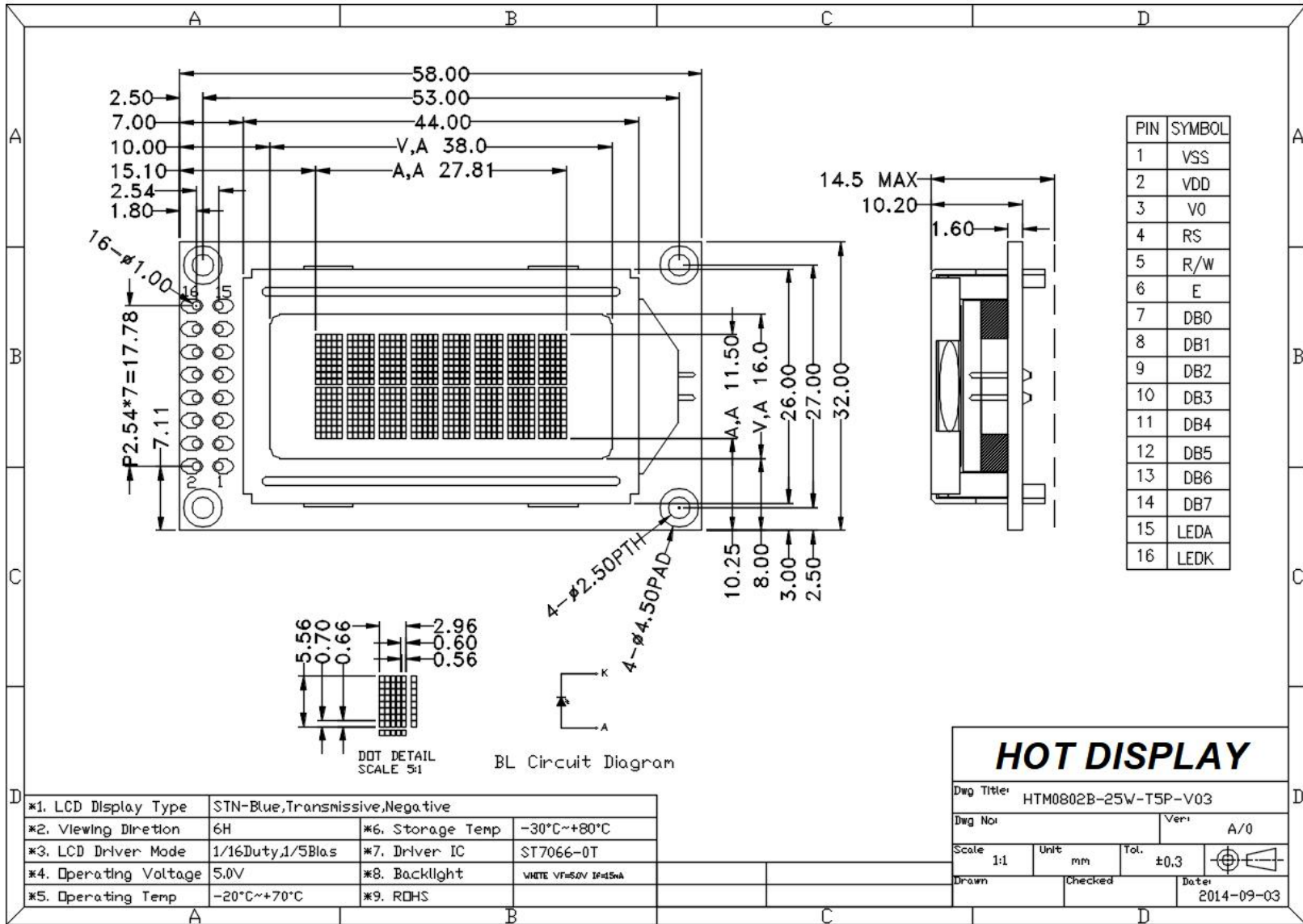

1.6 Schematic Diagram

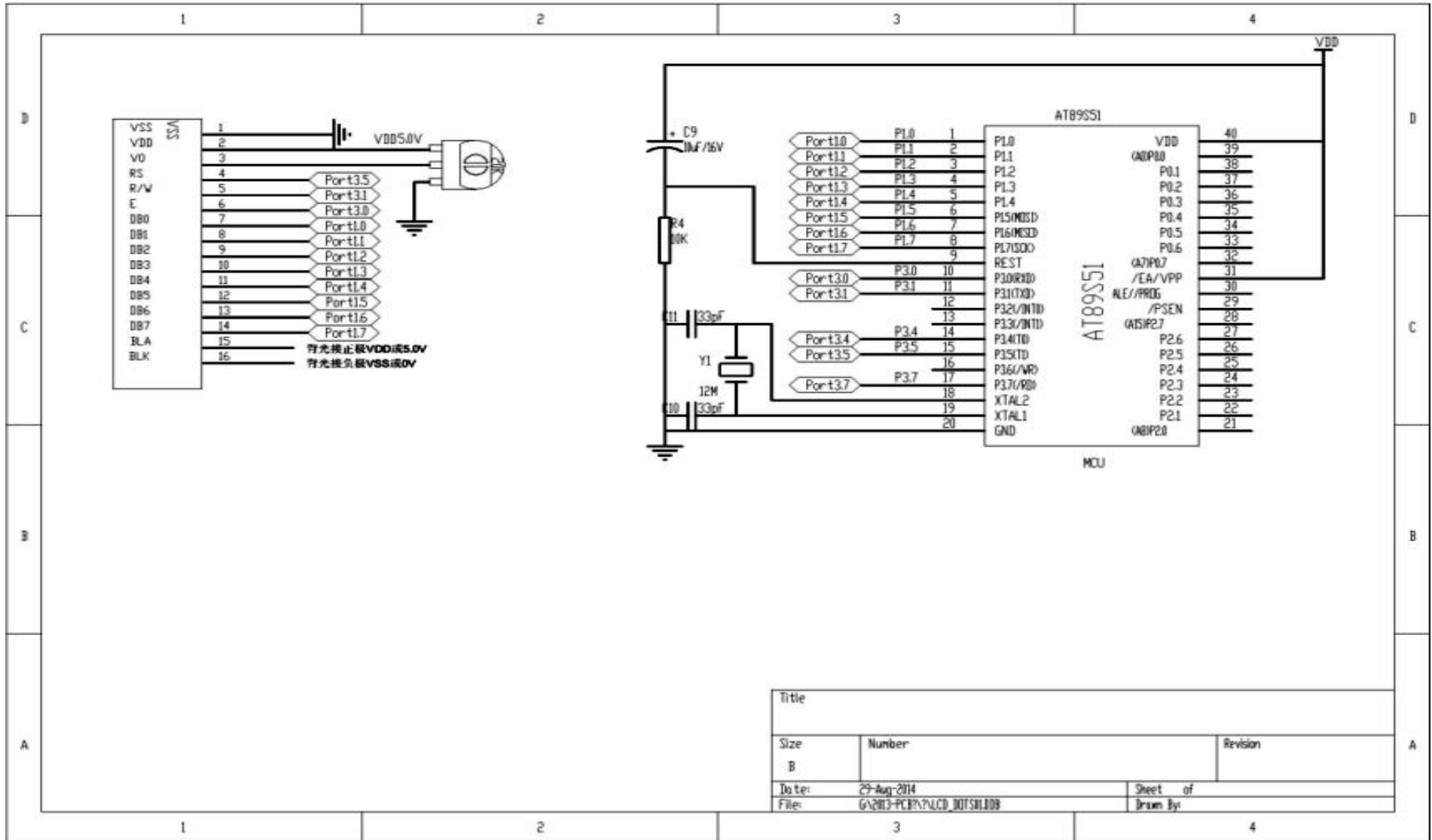

## 2. Absolute Maximum Ratings

Items	Symbol	MIN.	MAX.	Unit	Condition
Supply Voltage For Logic	V <sub>DD</sub>	-	6.5	V	V <sub>SS</sub> = 0V
Input Voltage	V <sub>IN</sub>	V <sub>SS</sub>	V <sub>DD</sub>	V	V <sub>SS</sub> = 0V
Supply Voltage For LCD	V <sub>DD-V0</sub>	-	6.5	V	-
Operating Temperature	T <sub>OP</sub>	-20	+70	°C	No Condensation
Storage Temperature	T <sub>st</sub>	-30	+80	°C	No Condensation

## 3. Electrical Characteristics

### 3.1 DC Characteristics

Items	Symbol	MIN.	TYP.	MAX.	Unit	Condition
Supply Voltage For Logic	V <sub>DD-VS</sub>	4.5	5.0	5.5	V	--
Supply Voltage Fro LCD	V <sub>DD-V</sub>	--	4.8/5.0	--	V	Ta= 0/-20 °C
		--	4.4	--	V	Ta= 25°C
		--	4.1/3.9	--	V	Ta= +50/+70 °C
Input High Voltage	V <sub>IH</sub>	2.2	--	V <sub>DD</sub>	V	--
Input Low Voltage	V <sub>IL</sub>	0	--	0.6	V	--
Output High Voltage	V <sub>OH</sub>	2.4	--	--	V	--
Output Low Voltage	V <sub>OL</sub>	--	--	0.4	V	--
Supply Current	I <sub>DD</sub>	--	0.2	0.5	mA	V <sub>DD</sub> =+5V
View Angle (V)	θ	-10	--	40	deg.	CR ≥ 2
View Angle (H)	φ	-30	--	30	deg.	CR ≥ 2
Contrast Ratio	CR	--	5	--	--	--
Response Time	T <sub>ON</sub>	--	180	230	mS	--
Response Time	T <sub>OFF</sub>	--	100	150	mS	--

### 3.2 LED Backlight Circuit

Items	Symbol	MIN.	TYP.	MAX.	Unit	Condition
Forword Voltage	V <sub>f</sub> BLA	-	5.0	-	V	-
Forword Current	I <sub>f</sub> BLA	-	15	20	mA	-



### 3.3 AC Characteristics

#### 3.3.1 Write and Read Operation

#### Write

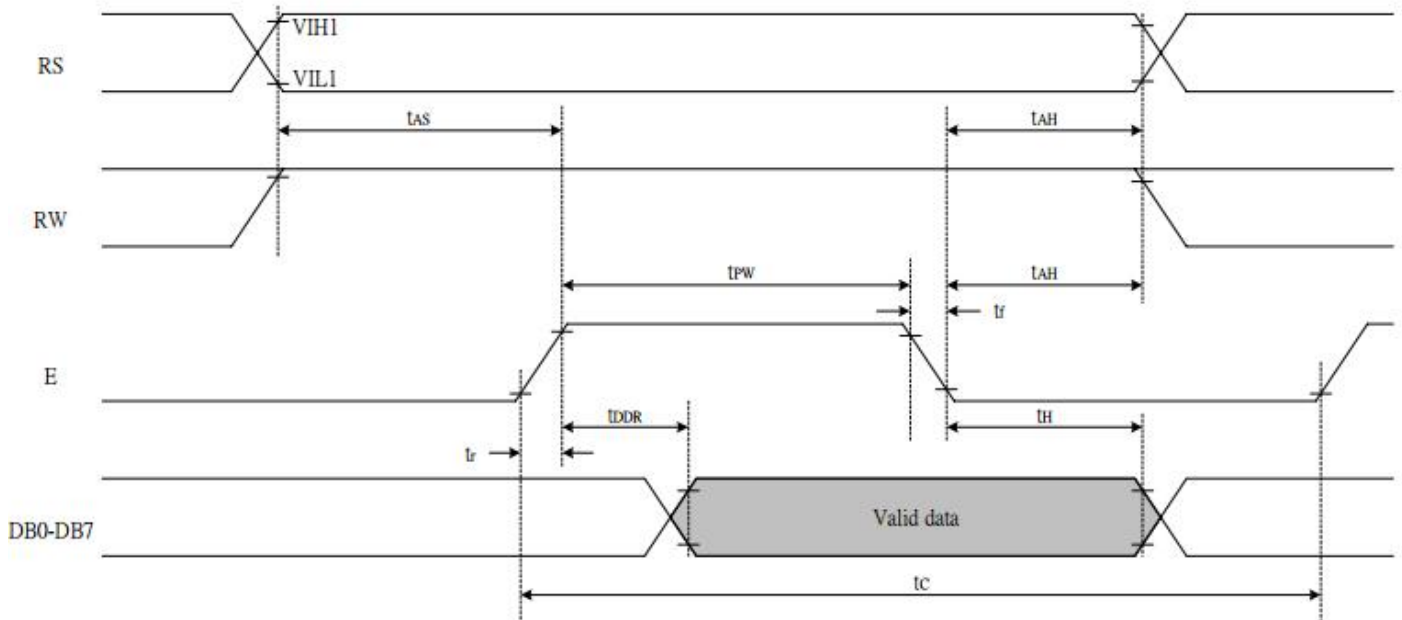

#### Read

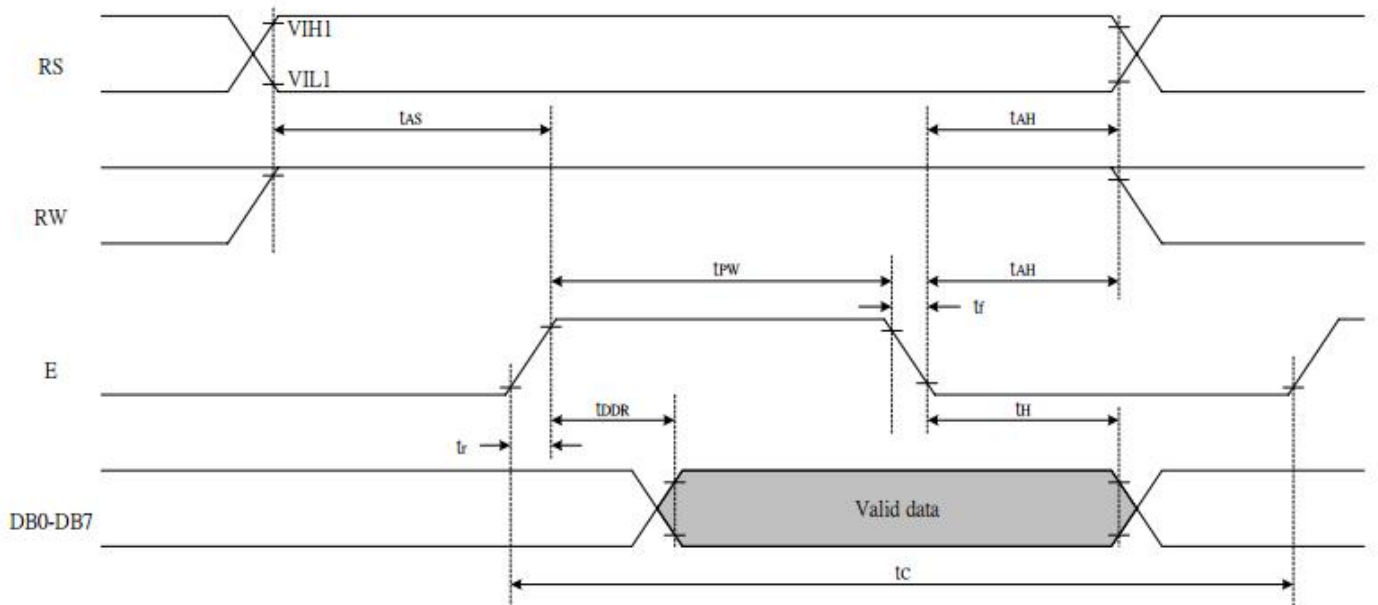



Item	Symbol	Limit (Min.)	Limit (Max.)	Unit
Enable Cycle Time	tCYCE	1000	--	ns
Enable Pules Width ( High level )	PWEH	450	--	ns
Enable Rise/Fall Time	tER,tEF	--	25	ns
Address Set-Up Time ( RS,R/W,E )	tAS	100	--	ns
Address Hole Time	tAH	10	--	ns
Data Set-Up Time	tDSW	100	--	ns
Data Delay Time	tDDR	--	190	ns
Data Hold Time	tDHR	20	--	ns

### 3.3.2 Busy flag check timing

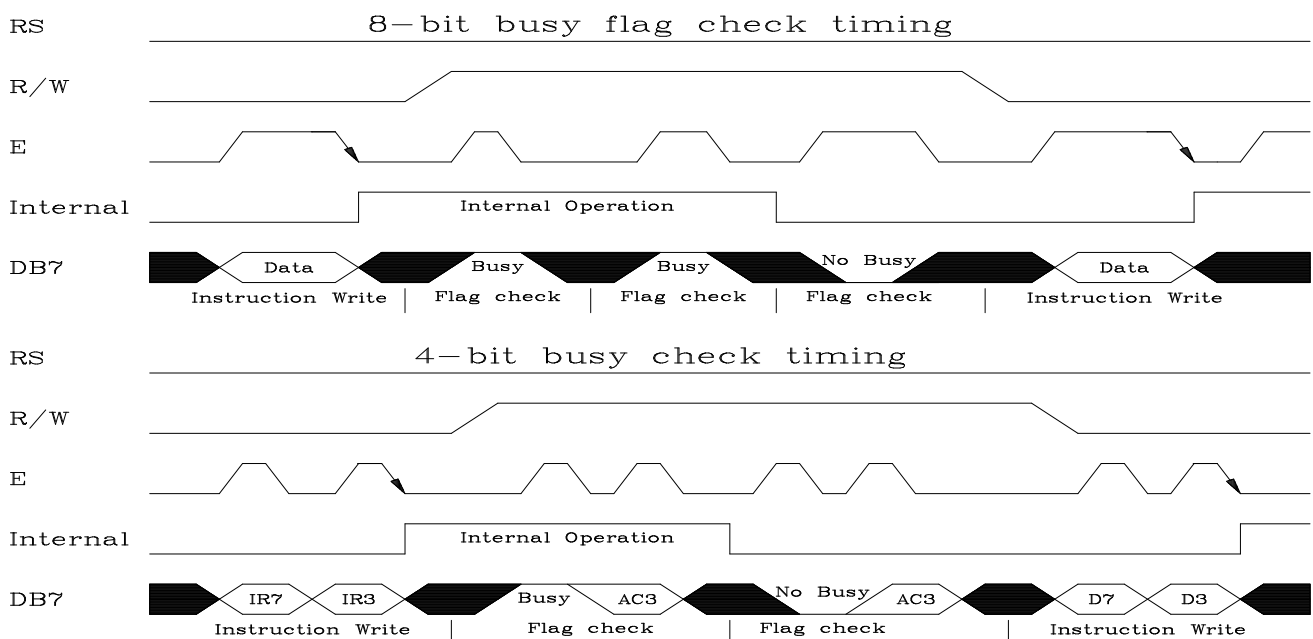

## 4. Function specifications

### 4.1 The Parallel Interface

RS	R/W	Operation
L	L	Instruction Write operation (MPU writes Instruction code into IR)
L	H	Read Busy Flag(DB7) and address counter (DB0 ~ DB6)
H	L	Data Write operation (MPU writes data into DR)
H	H	Data Read operation (MPU reads data from DR)

## 4.2 Display Memory Map

**N0. 7066-0T**

b7-b4 b3-b0	0000	0001	0010	0011	0100	0101	0110	0111	1000	1001	1010	1011	1100	1101	1110	1111
0000	CG RAM (1)			0	1	2	3	4			5	6	7	8	9	A
0001	(2)	!	1	A	Q	a	q				Г	Я	ш	.	Ц	Э
0010	(3)	"	2	B	R	b	r				Е	6	ь	u	Ш	Э
0011	(4)	#	3	C	S	c	s				Ж	В	н	и	а	ы
0100	(5)	\$	4	D	T	d	t				З	Г	ь	у	ф	н
0101	(6)	%	5	E	U	e	u				И	ё	а	ж	ц	г
0110	(7)	&	6	F	V	f	v				К	ж	н	у	ш	э
0111	(8)	'	7	G	W	g	w				Л	Э	я	і	.	Е
1000	(1)	(	8	H	X	h	x				П	и	о	и	.	і
1001	(2)	)	9	I	Y	i	y				У	а	о	т	~	э
1010	(3)	*	:	J	Z	j	z				Ф	к	.	↓	е	і
1011	(4)	+	;	K	C	k	c				Ч	я	"	и	с	*
1100	(5)	,	<	L	Q	l	q				Ш	и	и	и	и	и
1101	(6)	-	=	M	I	m	i				Ь	и	с	и	*	э
1110	(7)	.	>	N	^	n	e				Ы	и	ф	у	о	и
1111	(8)	/	?	O	_	o	e				Э	т	е	.	о	и

### 4.3 Display Commands

**Instruction Table:**

Instruction	Instruction Code										Description	Description Time (270KHz)	
	RS	R/W	DB7	DB6	DB5	DB4	DB3	DB2	DB1	DB0			
Clear Display	0	0	0	0	0	0	0	0	0	0	1	Write "20H" to DDRAM. and set DDRAM address to "00H" from AC	1.52 ms
Return Home	0	0	0	0	0	0	0	0	0	1	x	Set DDRAM address to "00H" from AC and return cursor to its original position if shifted. The contents of DDRAM are not changed.	1.52 ms
Entry Mode Set	0	0	0	0	0	0	0	0	1	I/D	S	Sets cursor move direction and specifies display shift. These operations are performed during data write and read.	37 us
Display ON/OFF	0	0	0	0	0	0	0	1	D	C	B	D=1:entire display on C=1:cursor on B=1:cursor position on	37 us
Cursor or Display Shift	0	0	0	0	0	0	1	S/C	R/L	x	x	Set cursor moving and display shift control bit, and the direction, without changing DDRAM data.	37 us
Function Set	0	0	0	0	0	1	DL	N	F	x	x	DL:interface data is 8/4 bits N:number of line is 2/1 F:font size is 5x11/5x8	37 us
Set CGRAM address	0	0	0	1	AC5	AC4	AC3	AC2	AC1	AC0		Set CGRAM address in address counter	37 us
Set DDRAM address	0	0	1	AC6	AC5	AC4	AC3	AC2	AC1	AC0		Set DDRAM address in address counter	37 us
Read Busy flag and address	0	1	BF	AC6	AC5	AC4	AC3	AC2	AC1	AC0		Whether during internal operation or not can be known by reading BF. The contents of address counter can also be read.	0 us
Write data to RAM	1	0	D7	D6	D5	D4	D3	D2	D1	D0		Write data into internal RAM (DDRAM/CGRAM)	37 us
Read data from RAM	1	1	D7	D6	D5	D4	D3	D2	D1	D0		Read data from internal RAM (DDRAM/CGRAM)	37 us

**Note:**

Be sure the ST7066U is not in the busy state (BF = 0) before sending an instruction from the MPU to the ST7066U. If an instruction is sent without checking the busy flag, the time between the first instruction and next instruction will take much longer than the instruction time itself. Refer to Instruction Table for the list of each instruction execution time.

## ■ Instruction Description

### ● Clear Display

	RS	RW	DB7	DB6	DB5	DB4	DB3	DB2	DB1	DB0
Code	0	0	0	0	0	0	0	0	0	1

Clear all the display data by writing "20H" (space code) to all DDRAM address, and set DDRAM address to "00H" into AC (address counter). Return cursor to the original status, namely, bring the cursor to the left edge on first line of the display. Make entry mode increment (I/D = "1").

### ● Return Home

	RS	RW	DB7	DB6	DB5	DB4	DB3	DB2	DB1	DB0
Code	0	0	0	0	0	0	0	0	1	x

Return Home is cursor return home instruction. Set DDRAM address to "00H" into the address counter. Return cursor to its original site and return display to its original status, if shifted. Contents of DDRAM does not change.

### ● Entry Mode Set

	RS	RW	DB7	DB6	DB5	DB4	DB3	DB2	DB1	DB0
Code	0	0	0	0	0	0	0	1	I/D	S

Set the moving direction of cursor and display.

- **I/D : Increment / decrement of DDRAM address (cursor or blink)**  
 When I/D = "High", cursor/blink moves to right and DDRAM address is increased by 1.  
 When I/D = "Low", cursor/blink moves to left and DDRAM address is decreased by 1.  
 \* CGRAM operates the same as DDRAM, when read from or write to CGRAM.
- **S: Shift of entire display**  
 When DDRAM read (CGRAM read/write) operation or S = "Low", shift of entire display is not performed. If S = "High" and DDRAM write operation, shift of entire display is performed according to I/D value (I/D = "1" : shift left, I/D = "0" : shift right).

S	I/D	Description
H	H	Shift the display to the left
H	L	Shift the display to the right

● **Display ON/OFF**

	RS	RW	DB7	DB6	DB5	DB4	DB3	DB2	DB1	DB0
Code	0	0	0	0	0	0	1	D	C	B

Control display/cursor/blink ON/OFF 1 bit register.

- **D : Display ON/OFF control bit**  
 When D = "High", entire display is turned on.  
 When D = "Low", display is turned off, but display data is remained in DDRAM.
- **C : Cursor ON/OFF control bit**  
 When C = "High", cursor is turned on.  
 When C = "Low", cursor is disappeared in current display, but I/D register remains its data.
- **B : Cursor Blink ON/OFF control bit**  
 When B = "High", cursor blink is on, that performs alternate between all the high data and display character at the cursor position.  
 When B = "Low", blink is off.

● **Cursor or Display Shift**

	RS	RW	DB7	DB6	DB5	DB4	DB3	DB2	DB1	DB0
Code	0	0	0	0	0	1	S/C	R/L	x	x

Without writing or reading of display data, shift right/left cursor position or display. This instruction is used to correct or search display data. During 2-line mode display, cursor moves to the 2nd line after 40th digit of 1st line. Note that display shift is performed simultaneously in all the line. When displayed data is shifted repeatedly, each line shifted individually. When display shift is performed, the contents of address counter are not changed.

S/C	R/L	Description	AC Value
L	L	Shift cursor to the left	AC=AC-1
L	H	Shift cursor to the right	AC=AC+1
H	L	Shift display to the left. Cursor follows the display shift	AC=AC
H	H	Shift display to the right. Cursor follows the display shift	AC=AC

● **Function Set**

	RS	RW	DB7	DB6	DB5	DB4	DB3	DB2	DB1	DB0
Code	0	0	0	0	1	DL	N	F	x	x

- **DL : Interface data length control bit**  
 When DL = "High", it means 8-bit bus mode with MPU.  
 When DL = "Low", it means 4-bit bus mode with MPU. So to speak, DL is a signal to select 8-bit or 4-bit bus mode.  
 When 4-bit bus mode, it needs to transfer 4-bit data by two times.
- **N : Display line number control bit**  
 When N = "Low", it means 1-line display mode.  
 When N = "High", 2-line display mode is set.
- **F : Display font type control bit**  
 When F = "Low", it means 5 x 8 dots format display mode  
 When F = "High", 5 x 11 dots format display mode.

N	F	No. of Display Lines	Character Font	Duty Factor
L	L	1	5x8	1/8
L	H	1	5x11	1/11
H	x	2	5x8	1/16

● **Set CGRAM Address**

RS	RW	DB7	DB6	DB5	DB4	DB3	DB2	DB1	DB0	
Code	0	0	0	1	AC5	AC4	AC3	AC2	AC1	AC0

Set CGRAM address to AC.

This instruction makes CGRAM data available from MPU.

● **Set DDRAM Address**

RS	RW	DB7	DB6	DB5	DB4	DB3	DB2	DB1	DB0	
Code	0	0	1	AC6	AC5	AC4	AC3	AC2	AC1	AC0

Set DDRAM address to AC.

This instruction makes DDRAM data available from MPU.

When 1-line display mode (N = 0), DDRAM address is from "00H" to "4FH".

In 2-line display mode (N = 1), DDRAM address in the 1st line is from "00H" to "27H", and DDRAM address in the 2nd line is from "40H" to "67H".

● **Read Busy Flag and Address**

	RS	RW	DB7	DB6	DB5	DB4	DB3	DB2	DB1	DB0
Code	0	1	BF	AC6	AC5	AC4	AC3	AC2	AC1	AC0

When BF = "High", indicates that the internal operation is being processed. So during this time the next instruction cannot be accepted.

The address Counter (AC) stores DDRAM/CGRAM addresses, transferred from IR.

After writing into (reading from) DDRAM/CGRAM, AC is automatically increased (decreased) by 1.

● **Write Data to CGRAM or DDRAM**

	RS	RW	DB7	DB6	DB5	DB4	DB3	DB2	DB1	DB0
Code	1	0	D7	D6	D5	D4	D3	D2	D1	D0

Write binary 8-bit data to DDRAM/CGRAM.

The selection of RAM from DDRAM, CGRAM, is set by the previous address set instruction : DDRAM address set, CGRAM address set. RAM set instruction can also determine the AC direction to RAM.

After write operation, the address is automatically increased/decreased by 1, according to the entry mode.

● **Read Data from CGRAM or DDRAM**

	RS	RW	DB7	DB6	DB5	DB4	DB3	DB2	DB1	DB0
Code	1	1	D7	D6	D5	D4	D3	D2	D1	D0

Read binary 8-bit data from DDRAM/CGRAM.

The selection of RAM is set by the previous address set instruction. If address set instruction of RAM is not performed before this instruction, the data that read first is invalid, because the direction of AC is not determined. If you read RAM data several times without RAM address set instruction before read operation, you can get correct RAM data from the second, but the first data would be incorrect, because there is no time margin to transfer RAM data.

In case of DDRAM read operation, cursor shift instruction plays the same role as DDRAM address set instruction : it also transfer RAM data to output data register. After read operation address counter is automatically increased/decreased by 1 according to the entry mode. After CGRAM read operation, display shift may not be executed correctly.

\* In case of RAM write operation, after this AC is increased/decreased by 1 like read operation. In this time, AC indicates the next address position, but you can read only the previous data by read instruction.

### 4.4 Basic Operating Sequence

#### 1) 8 Bit Interface

#### 2) 4 Bit Interface

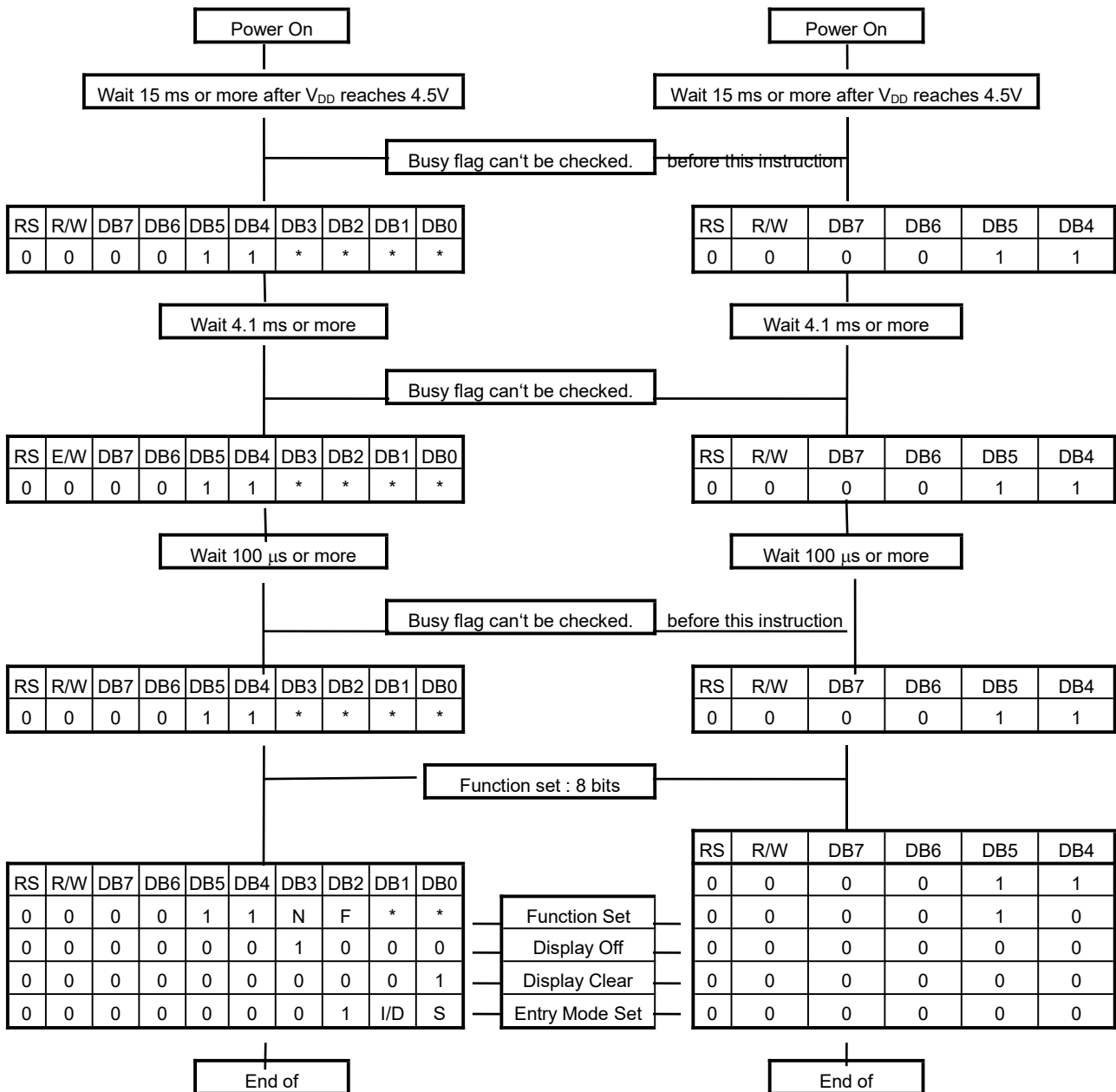

- Busy flag is checked after instructions are completed. If busy flag isn't checked, the waiting time between instructions should be longer than execution time of these instructions.

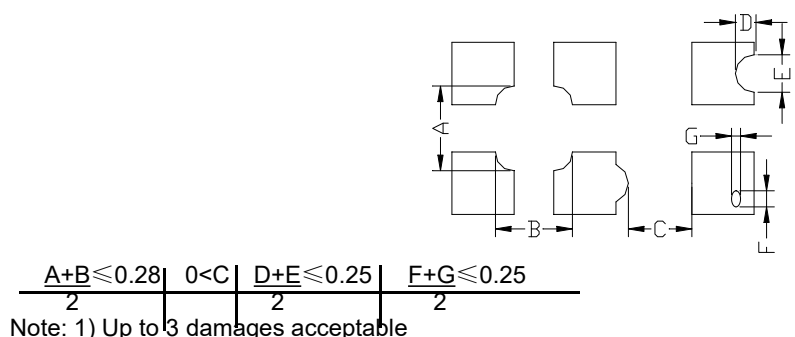

## 5. Inspection Standards

Item	Criterion for defects	Defect type
1) Display on inspection	(1) Non display (2) Vertical line is deficient (3) Horizontal line is deficient (4) Cross line is deficient	Major
2) Black / White spot	Size $\Phi$ (mm) $\Phi \leq 0.3$ Acceptable number $0.3 < \Phi \leq 0.45$ Ignore (note) $0.45 < \Phi \leq 0.6$ 3 $0.6 < \Phi$ 1 0	Minor
3) Black / White line	Length (mm) Width (mm) Acceptable number $L \leq 10$ $W \leq 0.03$ Ignore $5.0 \leq L \leq 10$ $0.03 < W \leq 0.04$ 3 $5.0 \leq L \leq 10$ $0.04 < W \leq 0.05$ 2 $1.0 \leq L \leq 10$ $0.05 < W \leq 0.06$ 2 $1.0 \leq L \leq 10$ $0.06 < W \leq 0.08$ 1 $L \leq 10$ $0.08 < W$ follows 2) point defect Defects separate with each other at an interval of more than 20mm	Minor
4) Display pattern	 <p style="text-align: center;"> <math>\frac{A+B \leq 0.28}{2}</math>   <math>0 &lt; C</math>   <math>\frac{D+E \leq 0.25}{2}</math>   <math>\frac{F+G \leq 0.25}{2}</math> </p> <p>Note: 1) Up to 3 damages acceptable  2) Not allowed if there are two or more pinholes every three-fourth inch.</p>	Minor
5) Spot-like contrast irregularity	Size $\Phi$ (mm) Acceptable Number $\Phi \leq 0.7$ Ignore (note) $0.7 < \Phi \leq 1.0$ 3 $1.0 < \Phi \leq 1.5$ 1 $1.5 < \Phi$ 0 Note: 1) Conformed to limit samples. 2) Intervals of defects are more than 30mm.	Minor
6) Bubbles in polarizer	Size $\Phi$ (mm) Acceptable Number $\Phi \leq 0.4$ Ignore (note) $0.4 < \Phi \leq 0.65$ 2 $0.65 < \Phi \leq 1.2$ 1 $1.2 < \Phi$ 0	Minor
7) Scratches and dent on the polarizer	Scratches and dent on the polarizer shall be in the accordance with "2) Black/white spot", and "3) Black/White line".	Minor
8) Stains on the surface of LCD panel	Stains which cannot be removed even when wiped lightly with a soft cloth or similar cleaning.	Minor
9) Rainbow color	No rainbow color is allowed in the optimum contrast on state within the active area.	Minor
10) Viewing area encroachment	Polarizer edge or line is visible in the opening viewing area due to polarizer shortness or sealing line.	Minor
11) Bezel appearance	Rust and deep damages that are visible in the bezel are rejected.	Minor
12) Defect of land surface contact	Evident crevices that are visible are rejected.	Minor
13) Parts mounting	(1) Failure to mount parts (2) Parts not in the specifications are mounted (3) For example: Polarity is reversed, HSC or TCP falls off.	Minor
14) Part alignment	(1) LSI, IC lead width is more than 50% beyond pad outline. (2) More than 50% of LSI, IC leads is off the pad outline.	Minor
15) Conductive foreign matter (solder ball, solder hips)	(1) $0.45 < \Phi$ , $N \geq 1$ (2) $0.3 < \Phi \leq 0.45$ , $N \geq 1$ , $\Phi$ : Average diameter of solder ball (unit: mm) (3) $0.5 < L$ , $N \geq 1$ , $L$ : Average length of solder chip (unit: mm)	Minor
16) Bezel flaw	Bezel claw missing or not bent	Minor
17) Indication on name plate (sampling indication label)	(1) Failure to stamp or label error, or not legible.(all acceptable if legible) (2) The separation is more than 1/3 for indication discoloration, in which the characters can be checked.	Minor

## 6. Handling Precautions

### 6.1 Mounting method

A panel of LCD module made by our company consists of two thin glass plates with polarizers that easily get damaged. And since the module is so constructed as to be fixed by utilizing fitting holes in the printed circuit board (PCB), extreme care should be used when handling the LCD modules.

### 6.2 Cautions of LCD handling and cleaning

When cleaning the display surface, use soft cloth with solvent (recommended below) and wipe lightly.

- Isopropyl alcohol
- Ethyl alcohol
- Trichlorotrifluoroethane

Do not wipe the display surface with dry or hard materials that will damage the polarizer surface.

Do not use the following solvent:

- Water
- Ketene
- Aromatics

### 6.3 Caution against static charge

The LCD module uses C-MOS LSI drivers. So we recommend you:

Connect any unused input terminal to  $V_{dd}$  or  $V_{ss}$ . Do not input any signals before power is turned on, and ground your body, work/assembly areas, assembly equipment to protect against static electricity.

### 6.4 Packaging

- Module employs LCD elements, and must be treated as such. Avoid intense shock and falls from a height.
- To prevent modules from degradation, do not operate or store them exposed directly to sunshine or high temperature/humidity.

### 6.5 Caution for operation

-It is an indispensable condition to drive LCD module within the limits of the specified voltage since the higher voltage over the limits may cause the shorter life of LCD module.

-An electrochemical reaction due to DC (direct current) causes LCD undesirable deterioration so that the uses of DC (direct current) drive should be avoided.

-Response time will be extremely delayed at lower temperature than the operating temperature range and on the other hand at higher temperature LCD module may show dark color in them. However those phenomena do not mean malfunction or out of order of LCD module, which will come back in the specified operating temperature.

### 6.6 Storage

In the case of storing for a long period of time, the following ways are recommended:

- Storage in polyethylene bag with the opening sealed so as not to enter fresh air outside in it. And with not desiccant.
- Placing in a dark place where neither exposure to direct sunlight nor light is. Keeping the storage temperature range.
- Storing with no touch on polarizer surface by any thing else.

### 6.7 Safety

-It is recommendable to crush damaged or unnecessary LCD into pieces and to wash off liquid crystal by either of solvents such as acetone and ethanol, which should be burned up later.

-When any liquid leaked out of a damaged glass cell comes in contact with your hands, please wash it off well at once with soap and water.