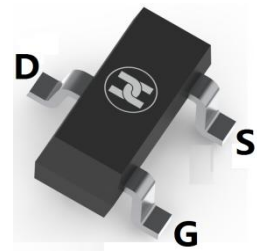
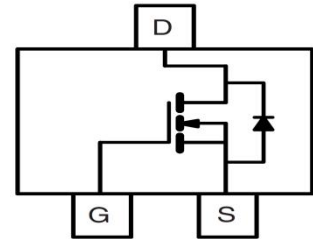

MOSFET (N-CHANNEL)
FEATURES

- Low on-resistance: $V_{DS}=100V, R_{DS(ON)}=320m\Omega @ V_{GS}=10V, I_D=1A$
- Low Input Capacitance
- Fast Switching Speed
- Low Input/Output Leakage
- Surface Mount device

SOT-23

MECHANICAL DATA

- Case: SOT-23
- Case Material: Molded Plastic. UL flammability
- Classification Rating: 94V-0
- Weight: 0.008 grams (approximate)
- Marking: 1002

MAXIMUM RATINGS ($T_A = 25^\circ\text{C}$ unless otherwise noted)

Parameter	Symbol	Value	Unit
Drain-source voltage	V_{DS}	100	V
Gate-source voltage	V_{GS}	± 20	V
Continuous drain current	I_D	2	A
Pulsed drain current (Note 1)	I_{DM}	5	A
Power dissipation	P_D	1	W
Thermal resistance from Junction to ambient	$R_{\theta JA}$	80	$^\circ\text{C/W}$
Junction temperature	T_J	150	$^\circ\text{C}$
Storage temperature	T_{STG}	-55 ~ +150	$^\circ\text{C}$

ELECTRICAL CHARACTERISTICS ($T_A = 25^\circ\text{C}$ unless otherwise specified)

Parameter	Symbol	Min	Typ	Max	Unit	Conditions
STATIC CHARACTERISTICS						
Drain-Source breakdown voltage	$V_{(BR)DSS}$	100			V	$V_{GS}=0V, I_D=250\mu A$
Zero gate voltage drain current	I_{DSS}			1	μA	$V_{DS}=100V, V_{GS}=0V$
Gate-body leakage current	I_{GSS}			± 100	nA	$V_{DS}=0V, V_{GS}=\pm 20V$
Gate-threshold voltage (note 1)	$V_{GS(th)}$	0.8	1.2	1.6	V	$V_{DS}=V_{GS}, I_D=250\mu A$
Drain-source on-resistance (note 1)	$R_{DS(ON)}$		220	320	m Ω	$V_{GS}=10V, I_D=1A$
			300	450	m Ω	$V_{GS}=4.5V, I_D=1A$
Diode forward voltage (note 1)	V_{SD}		0.7	1.2	V	$I_S=1A, V_{GS}=0V$
DYNAMIC CHARACTERISTICS						
Input capacitance	C_{iss}		500		pF	$V_{DS}=15V, V_{GS}=0V, f=1MHz$
Output capacitance	C_{oss}		30		pF	
Reverse transfer capacitance	C_{rss}		15		pF	
Gate Resistance	R_g		3		Ω	$V_{DS}=0V, V_{GS}=0V, f=1MHz$
Total gate charge	Q_g		10		nC	$V_{DD}=80V, V_{GS}=10V, I_D=1A$
Gate-source charge	Q_{gs}		1.6		nC	
Gate-drain charge	Q_{gd}		1.8		nC	
Turn-on delay time	$t_{d(on)}$		1.6		nS	$V_{DS}=50V, V_{GS}=10V, R_{GEN}=3\Omega, I_D=1A$
Turn-on rise time	t_r		18		nS	
Turn-off delay time	$t_{d(off)}$		12		nS	
Turn-off fall time	t_f		20		nS	

Note: 1. Pulse test ; Pulse width $\leq 300\mu s$, Duty cycle $\leq 2\%$.

MOSFET (N-CHANNEL)

Typical Characteristics

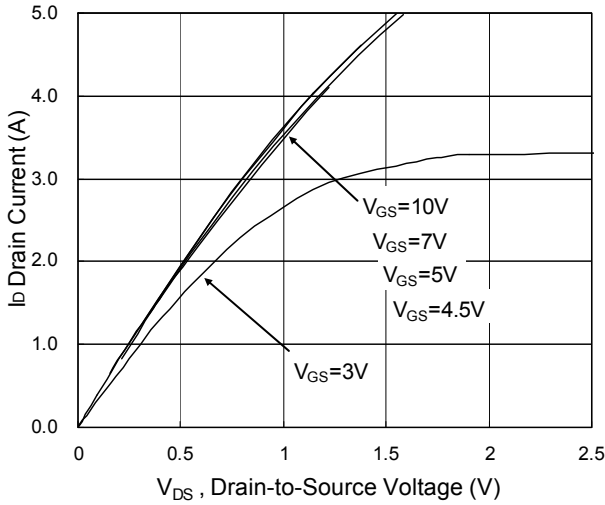

Fig.1 Typical Output Characteristics

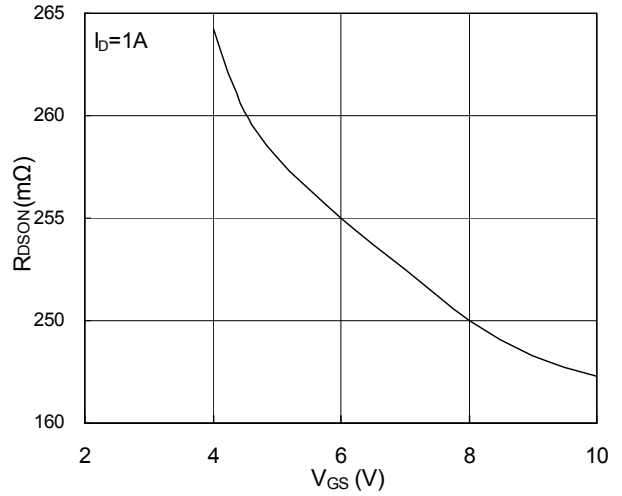
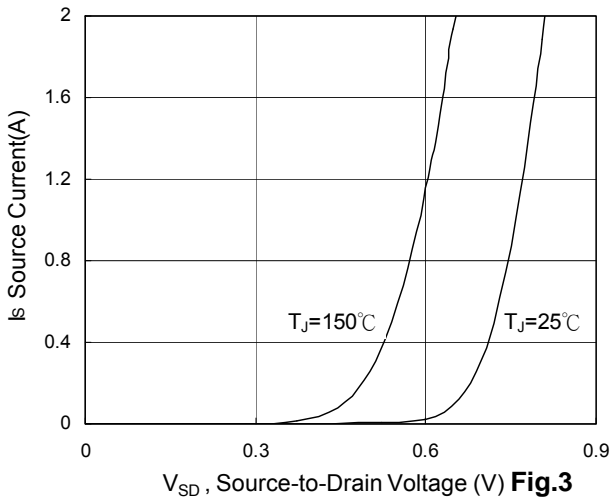

Fig.2 On-Resistance vs. Gate-Source



Forward Characteristics of Reverse

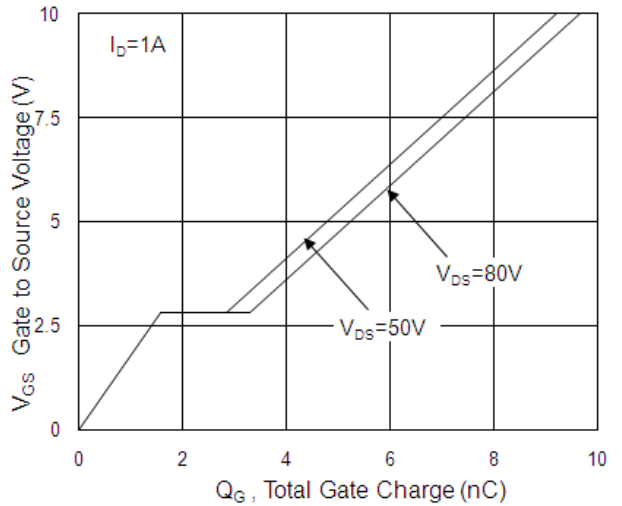

Fig.4 Gate-Charge Characteristics

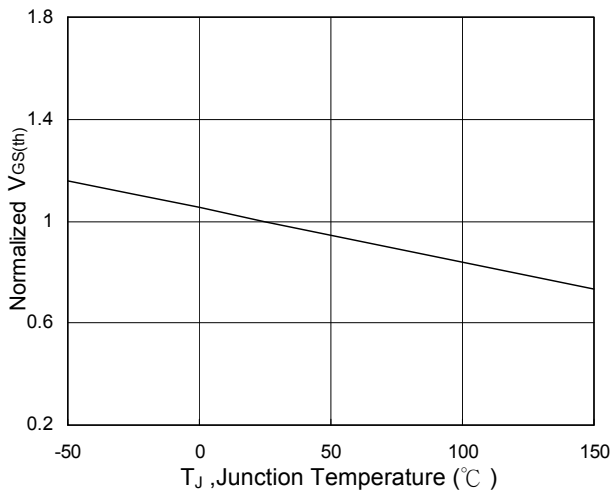

Fig.5 Normalized $V_{GS(th)}$ vs. T_J

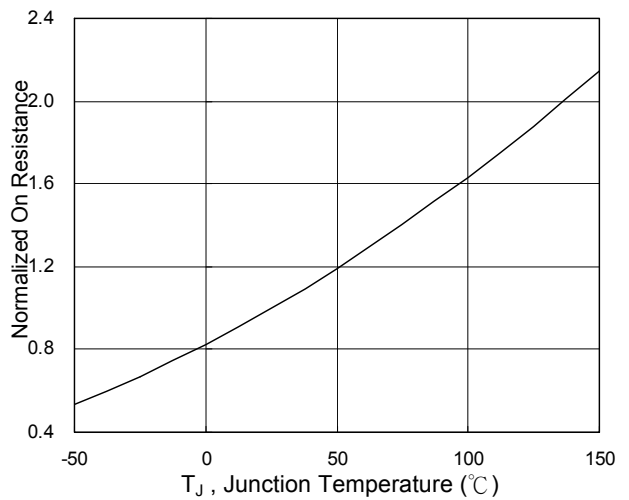

Fig.6 Normalized $R_{DS(ON)}$ vs. T_J

MOSFET (N-CHANNEL)

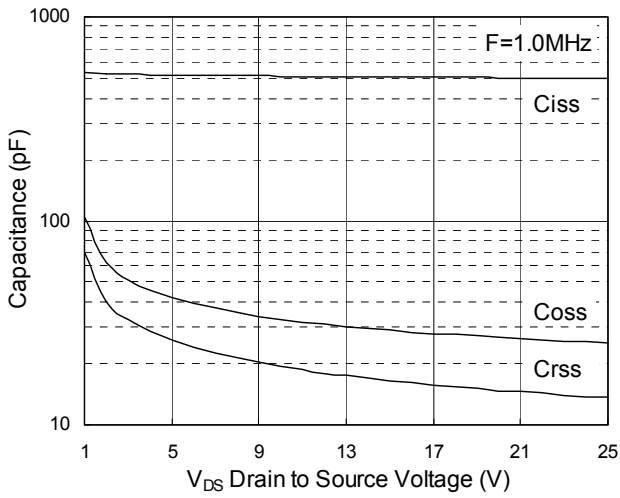

Fig.7 Capacitance

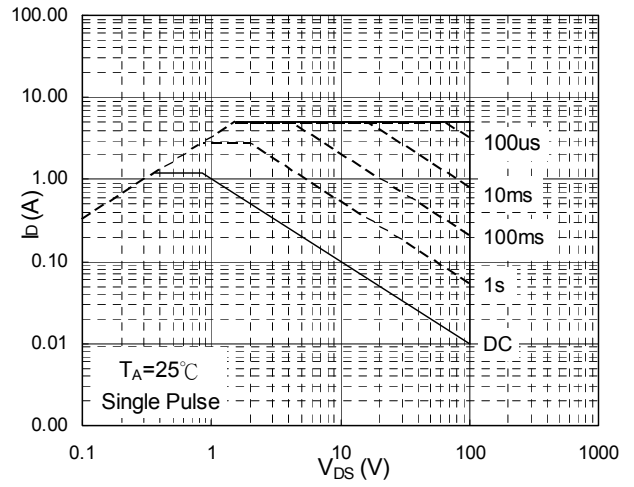

Fig.8 Safe Operating Area

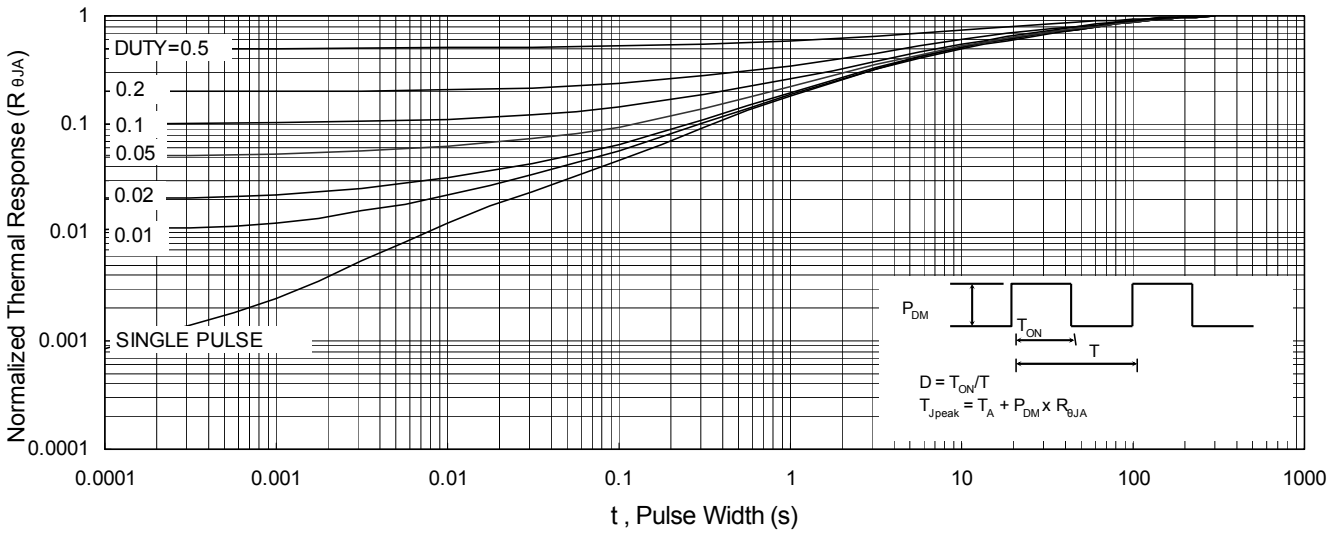

Fig.9 Normalized Maximum Transient Thermal Impedance

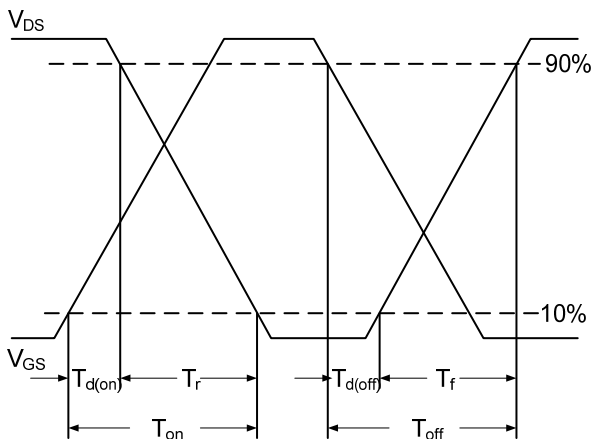

Fig.10 Switching Time Waveform

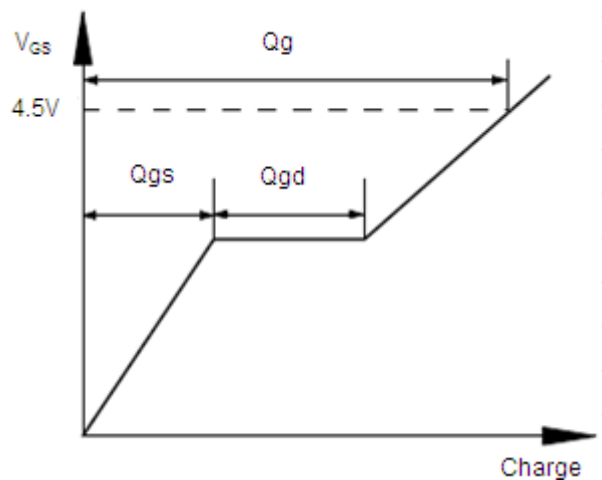
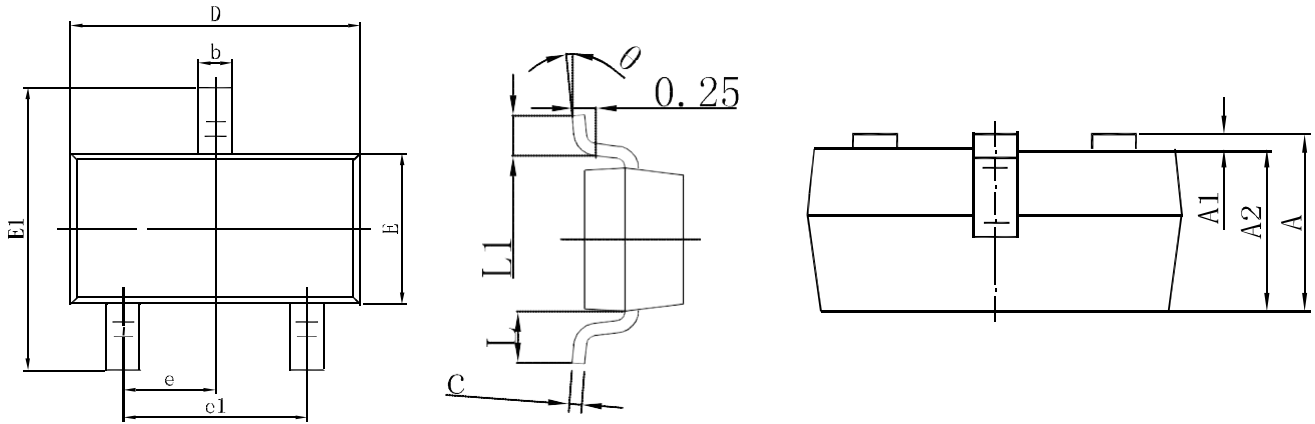
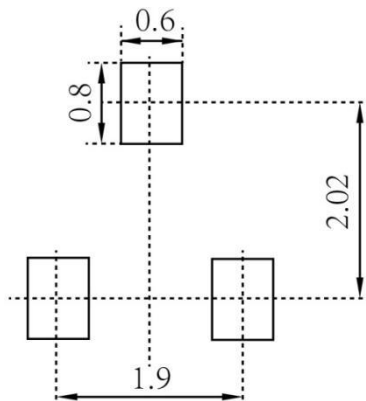

Fig.11 Gate Charge Waveform

MOSFET (N-CHANNEL)
SOT-23 Package Outline Dimensions

Symbol	Dimensions In Millimeters		Dimensions In Inches	
	Min.	Max.	Min.	Max.
A	0.900	1.150	0.035	0.045
A1	0.000	0.100	0.000	0.004
A2	0.900	1.050	0.035	0.041
b	0.300	0.500	0.012	0.020
c	0.080	0.150	0.003	0.006
D	2.800	3.000	0.110	0.118
E	1.200	1.400	0.047	0.055
E1	2.250	2.550	0.089	0.100
e	0.950 TYP		0.037 TYP	
e1	1.800	2.000	0.071	0.079
L	0.550 REF		0.022 REF	
L1	0.300	0.500	0.012	0.020
θ	0°	8°	0°	8°

SOT-23 Suggested Pad Layout

Note:

1. Controlling dimension: in millimeters
2. General tolerance: $\pm 0.05\text{mm}$
3. The pad layout is for reference purposes only

MOSFET (N-CHANNEL)

SOT-23 Tape and Reel

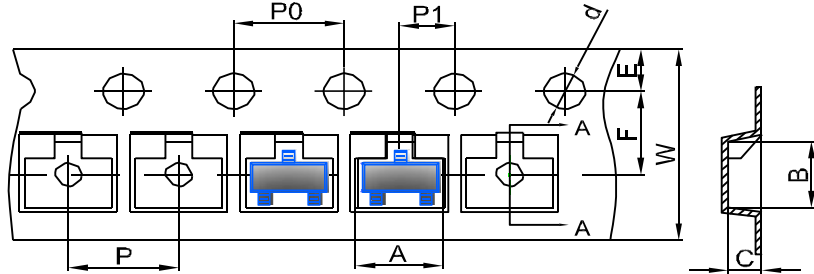
SOT-23 Embossed Carrier Tape



DIMENSIONS ARE IN MILLIMETER										
TYPE	A	B	C	d	E	F	P0	P	P1	W
SOT-23	3.15	2.77	1.22	Ø1.50	1.75	3.50	4.00	4.00	2.00	8.00
TOLERANCE	±0.1	±0.1	±0.1	±0.1	±0.1	±0.1	±0.1	±0.1	±0.1	±0.1

SOT-23 Tape Leader and Trailer

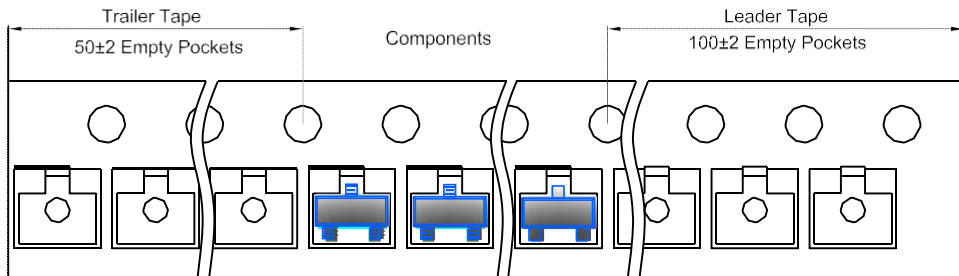

SOT-23 Reel

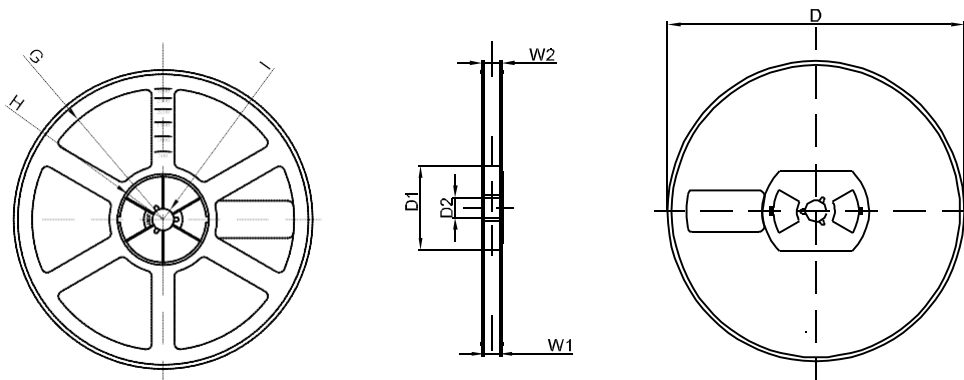

DIMENSIONS ARE IN MILLIMETER								
REEL OPTION	D	D1	D2	G	H	I	W1	W2
7" DIA	Ø178	54.40	13.00	R78	R25.60	R6.50	9.50	12.30
TOLERANCE	±2	±1	±1	±1	±1	±1	±1	±1