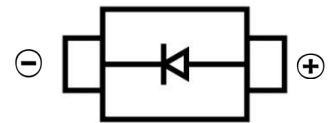

**SWITCHING DIODE**
**FEATURES**

- High Conductance
- Fast Switching
- Small Surface Mount device
- For General Purpose Switching Applications

**SOD-123**
**MECHANICAL DATA**

- Case: SOD-123
- Case Material: Molded Plastic. UL flammability
- Classification Rating: 94V-0
- Weight: 0.005 grams (approximate)

**MAXIMUM RATINGS (T<sub>A</sub> = 25°C unless otherwise noted)**

Parameter	Symbol	Value	Unit
Non-Repetitive Peak Reverse Voltage	V <sub>RM</sub>	250	V
DC Blocking Reverse Voltage	V <sub>R</sub>	200	V
RMS Reverse Voltage	V <sub>R(RMS)</sub>	141	V
Average Rectified Output Current	I <sub>O</sub>	200	mA
Non-Repetitive Peak Forward Surge Current @t@=8.3ms	I <sub>FSM</sub>	2.0	A
Power Dissipation	P <sub>D</sub>	500	mW
Thermal Resistance From Junction To Ambient	R <sub>θJA</sub>	250	°C/W
Junction Temperature	T <sub>J</sub>	150	°C
Storage Temperature	T <sub>STG</sub>	-55 ~+150	°C

**ELECTRICAL CHARACTERISTICS (T<sub>A</sub> = 25°C unless otherwise specified)**

Parameter	Symbol	Min	Typ	Max	Unit	Conditions
Forward Voltage	V			1.0		I <sub>F</sub> =100mA
				1.25		I <sub>F</sub> =200mA
Reverse current	I <sub>R</sub>			0.1	uA	V <sub>R</sub> =200V
Diode capacitance	C <sub>D</sub>			5	pF	V <sub>R</sub> =0V, f=1MHz
Reverse recovery time	T <sub>RR</sub>			4	nS	I <sub>F</sub> =I <sub>R</sub> =30mA, I <sub>rr</sub> =0.1X I <sub>R</sub> , R <sub>L</sub> =100Ω

SWITCHING DIODE

Typical Characteristics

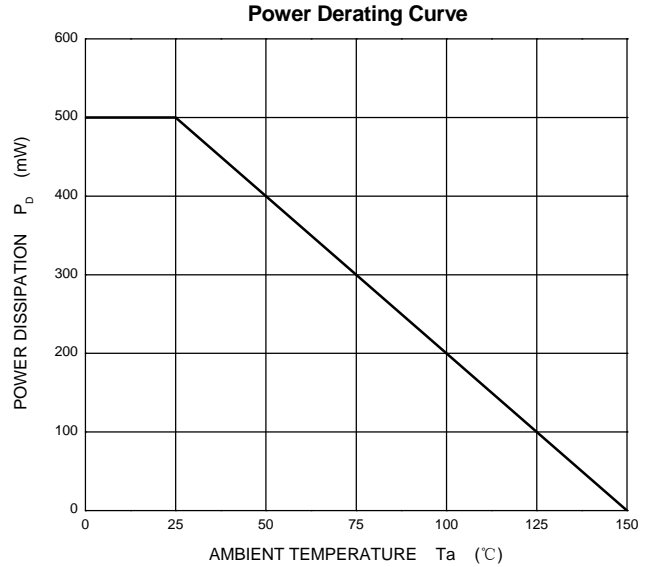
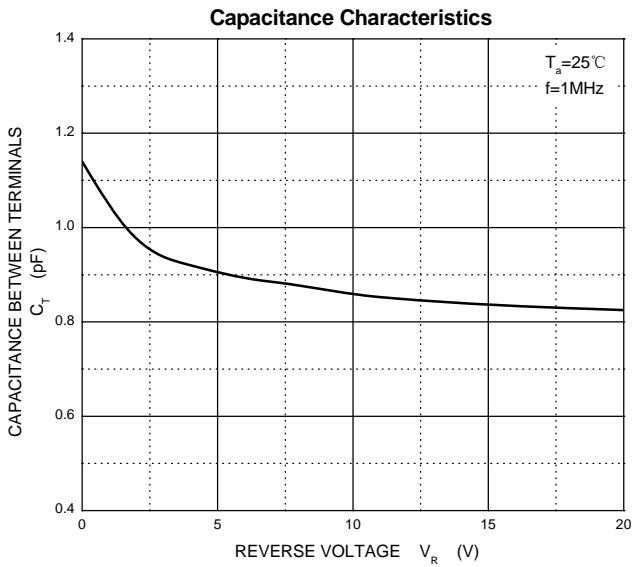
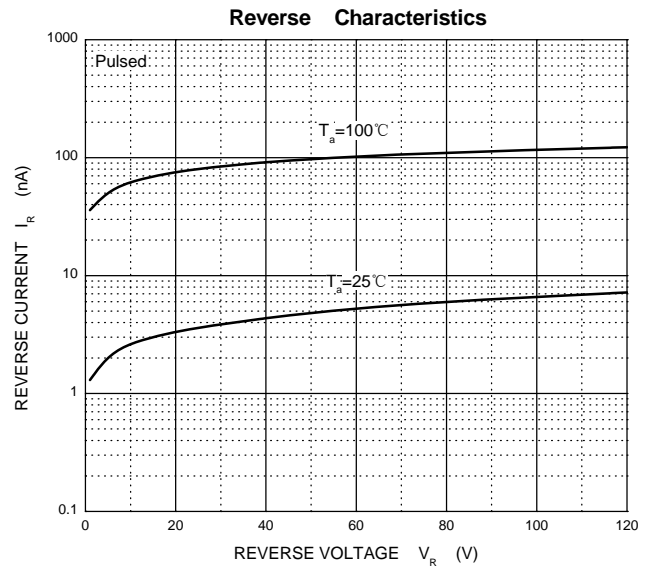
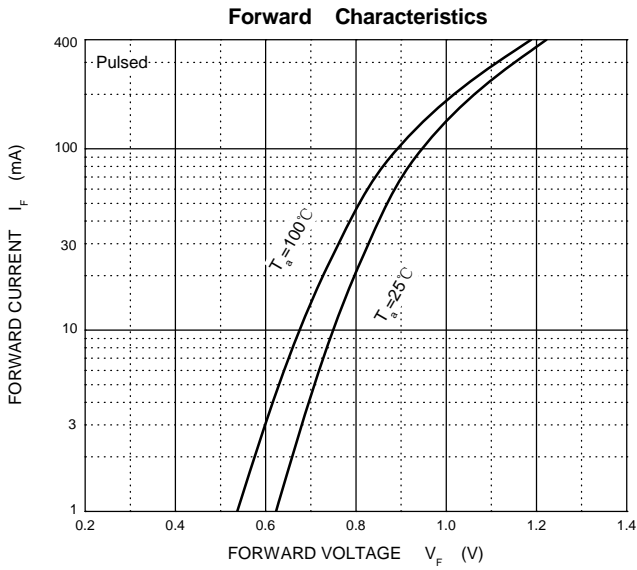

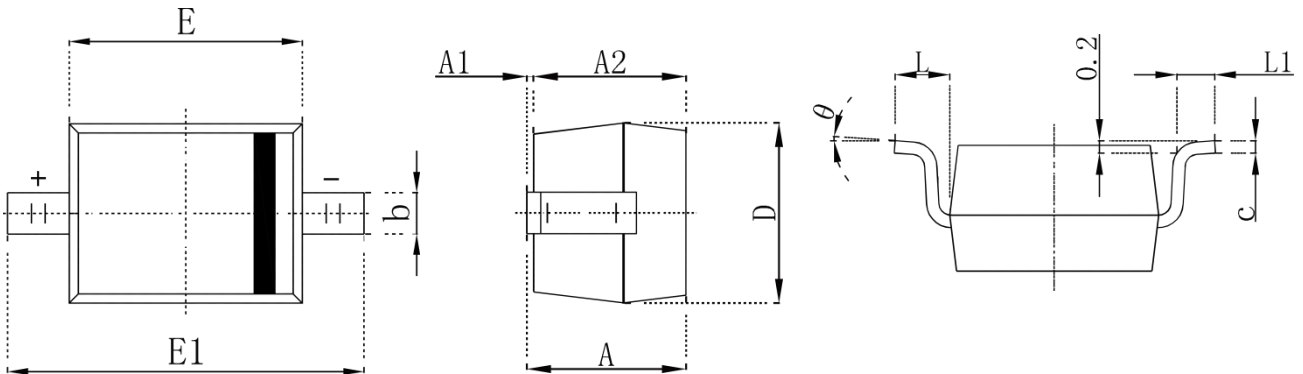
**SWITCHING DIODE**
**SOD-123 Package Outline Dimensions**

Symbol	Dimensions In Millimeters		Dimensions In Inches	
	Min.	Max.	Min.	Max.
A	1.050	1.250	0.041	0.049
A1	0.000	0.100	0.000	0.004
A2	1.050	1.150	0.041	0.045
b	0.450	0.650	0.018	0.026
c	0.080	0.150	0.003	0.006
D	1.500	1.700	0.059	0.067
E	2.600	2.800	0.102	0.110
E1	3.550	3.850	0.140	0.152
L	0.500REF		0.020 REF	
L1	0.250	0.450	0.010	0.018
θ	0°	8°	0°	8°

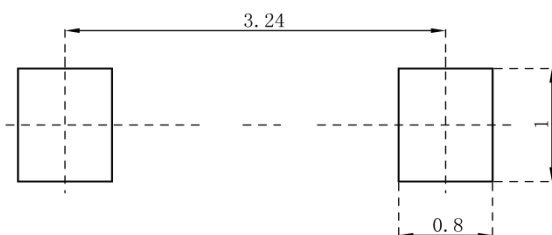
**SOD-123 Suggested Pad Layout**

**Note:**

1. Controlling dimension: in millimeters
2. General tolerance:  $\pm 0.05\text{mm}$
3. The pad layout is for reference purposes only

## SOD-123 Tape and Reel

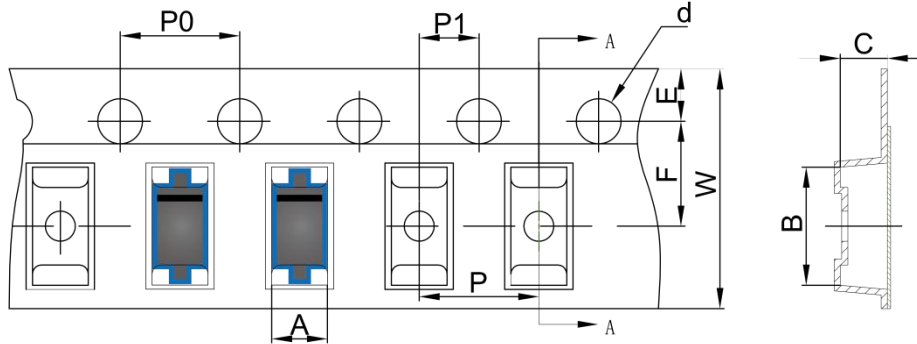
### SOD-123 Embossed Carrier Tape



### SOD-123 Tape Leader and Trailer

DIMENSIONS ARE IN MILLIMETER										
TYPE	A	B	C	d	E	F	P0	P	P1	W
SOD-123	1.85	3.95	1.57	Ø1.55	1.75	3.50	4.00	4.00	2.00	8.00
TOLERANCE	±0.1	±0.1	±0.1	±0.1	±0.1	±0.1	±0.1	±0.1	±0.1	±0.1

### SOD-123 Reel

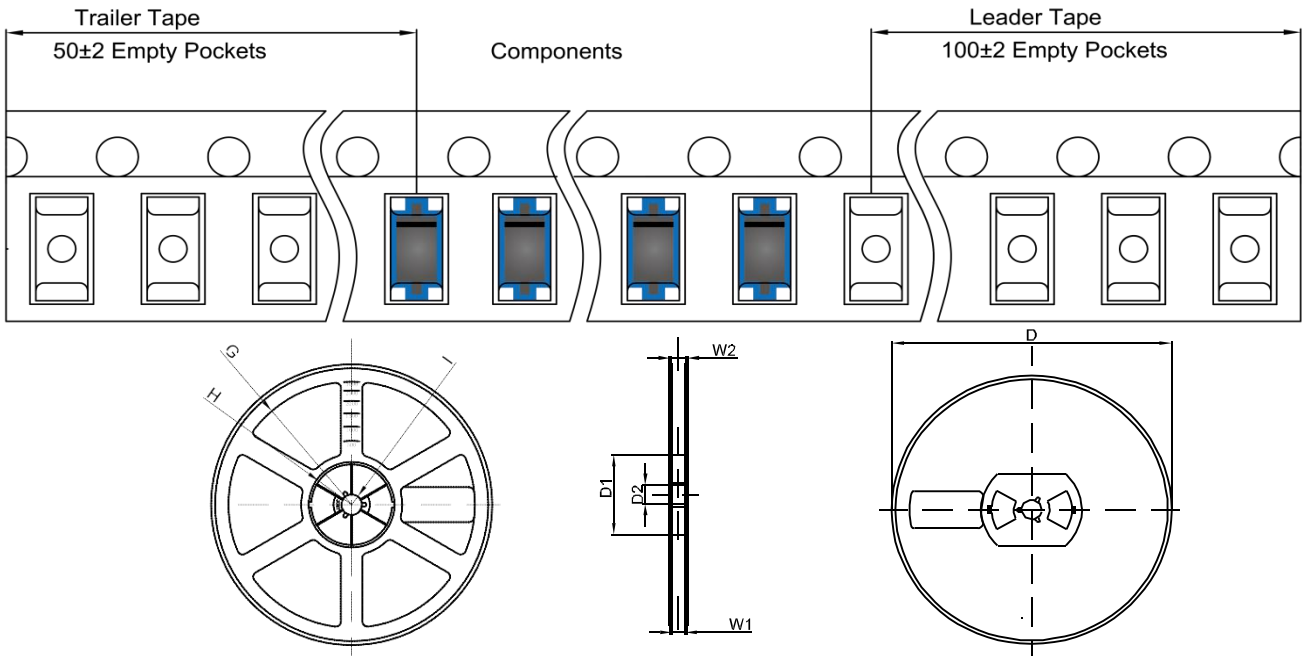

DIMENSIONS ARE IN MILLIMETER								
REEL OPTION	D	D1	D2	G	H	I	W1	W2
7" DIA	Ø178	54.40	13.00	R78	R25.60	R6.50	9.50	12.30
TOLERANCE	±2	±1	±1	±1	±1	±1	±1	±1