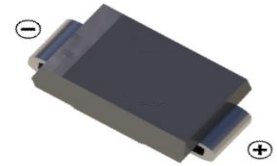
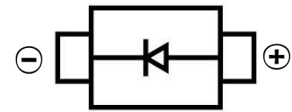

SUPER FAST RECOVERY RECTIFIER DIODE
FEATURES

- Glass passivated junction
- Low reverse leakage current
- Low forward voltage drop
- High current capability
- Super fast recovery time
- Surface Mount device

SMB

MECHANICAL DATA

- Case: SMB(DO-214AA)
- Case Material: Molded Plastic. UL flammability
- Classification Rating: 94V-0
- Weight: 0.088 grams (approximate)

MAXIMUM RATINGS AND CHARACTERISTICS(T_A = 25°C unless otherwise noted)

Parameter	Symbol	Value	Unit
Maximum Recurrent Peak Reverse Voltage	V _{RRM}	200	V
DC Blocking Reverse Voltage	V _R	200	V
RMS Reverse Voltage	V _{R(RMS)}	140	V
Maximum Average Forward Rectified Current	I _F	2	A
Non-Repetitive Peak Forward Surge Current @t=8.3ms	I _{FSM}	50	A
Thermal Resistance From Junction To Ambient	R _{θJA}	25	°C/W
Reverse Recovery Time(@I _F =0.5A, I _R =1.0A, I _{RR} =0.25A)	t _{rr}	35	nS
Junction Temperature	T _J	-55 ~+150	°C
Storage Temperature	T _{STG}	-55 ~+150	°C

ELECTRICAL CHARACTERISTICS (T_A = 25°C unless otherwise specified)

Parameter	Symbol	Min	Typ	Max	Unit	Conditions
Forward voltage	V _F			0.95	V	I _F =2A
Reverse current @T _A =25°C	I _R			5	μA	V _R =200V
Reverse current @T _A =125°C	I _R			350	μA	V _R =200V
Diode capacitance	C _D		25		pF	V _R =4V,f=1MHz

SUPER FAST RECOVERY RECTIFIER DIODE

Typical Characteristics

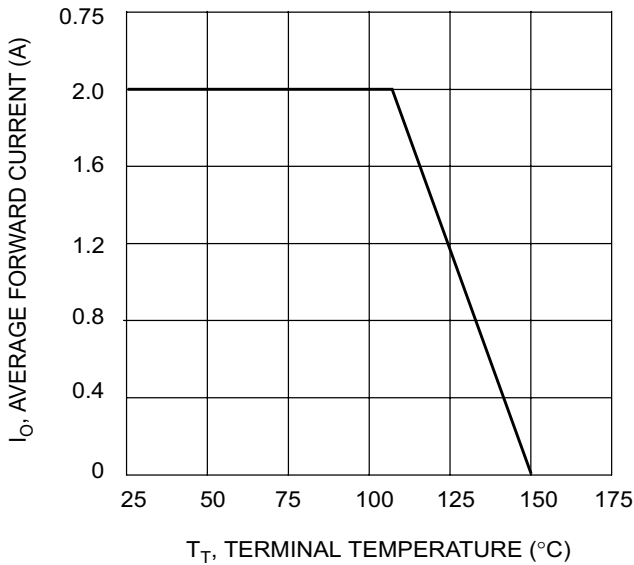

T_j , TERMINAL TEMPERATURE (°C)
Fig. 1 Forward Current Derating Curve

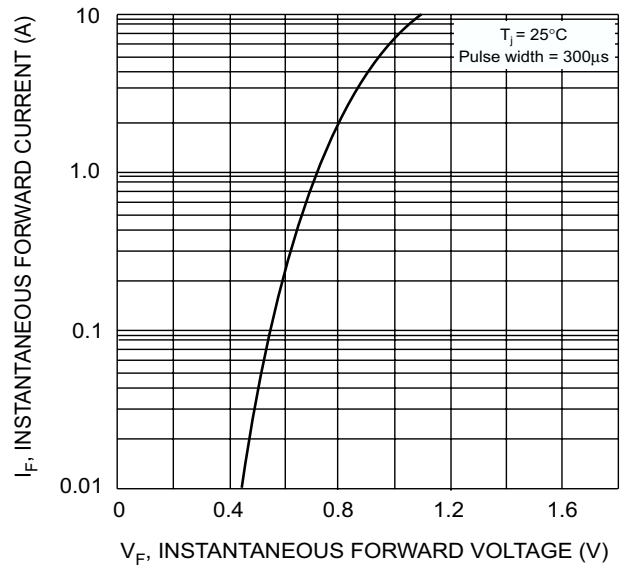

V_f , INSTANTANEOUS FORWARD VOLTAGE (V)
Fig. 2 Typical Forward Characteristics

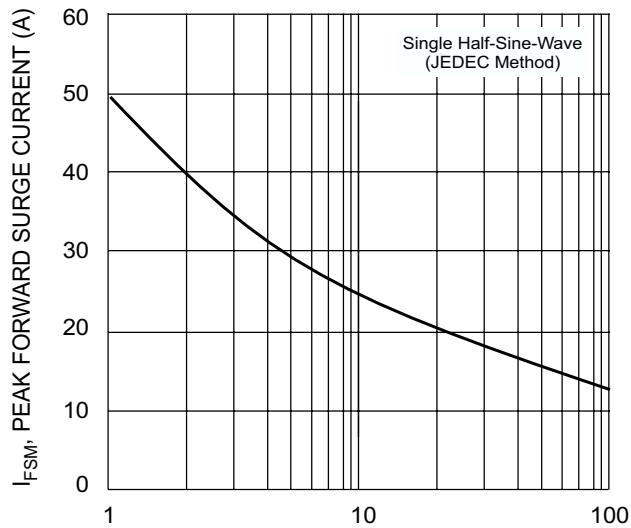

NUMBER OF CYCLES AT 60Hz
Fig. 3 Surge Current Derating Curve

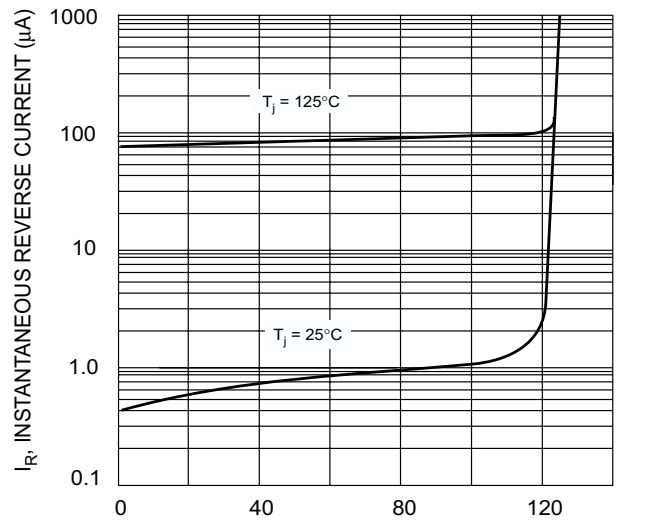

PERCENT OF RATED PEAK REVERSE VOLTAGE (%)
Fig. 4 Typical Reverse Characteristics

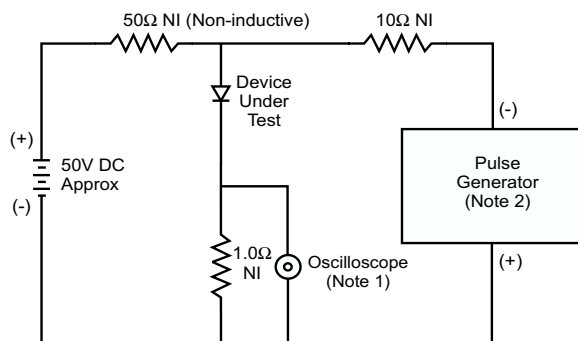

Notes:
1. Rise Time = 7.0ns max. Input Impedance = 1.0MΩ, 22pF.
2. Rise Time = 10ns max. Input Impedance = 50Ω.

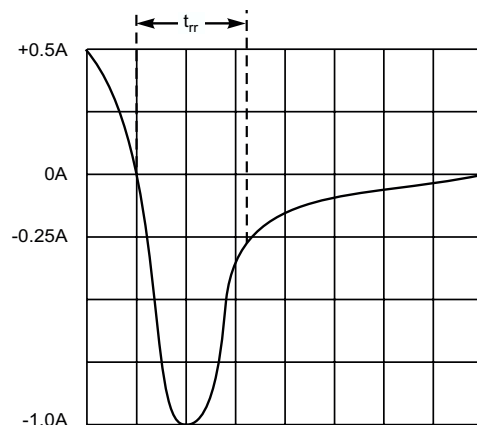

Set time base for 50/100 ns/cm

Fig. 5 Reverse Recovery Time Characteristic and Test Circuit

SUPER FAST RECOVERY RECTIFIER DIODE

SMB Package Outline Dimensions

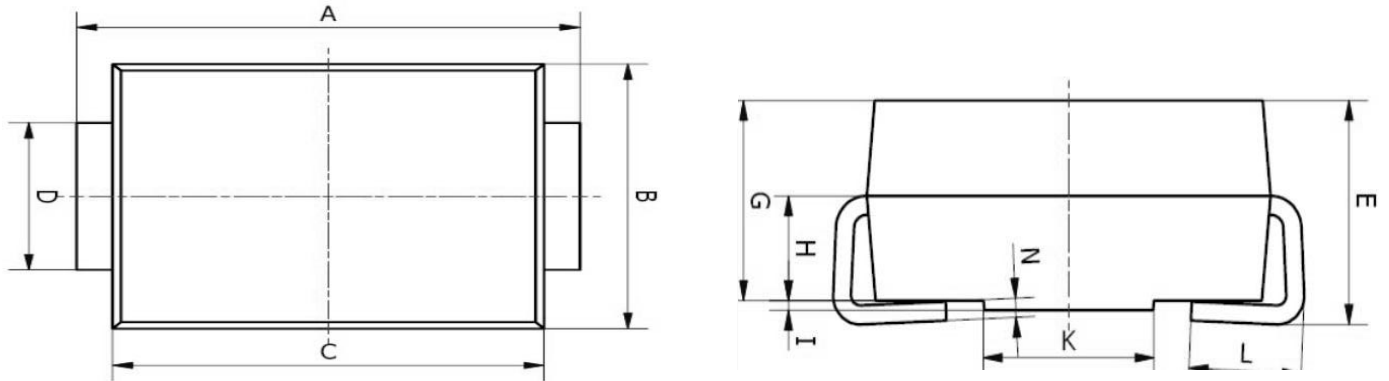

Symbol	Dimensions In Millimeters		Dimensions In Inches	
	Min.	Max.	Min.	Max.
A	5.00	5.45	0.197	0.215
B	3.20	4.00	0.126	0.157
C	4.30	4.70	0.169	0.185
D	1.80	2.20	0.071	0.087
E	2.20	2.50	0.087	0.098
G	1.90	2.30	0.075	0.090
H	0.95	1.25	0.037	0.049
I	0.05	0.15	0.002	0.006
K	1.70	2.10	0.067	0.083
L	0.90	1.60	0.035	0.063
N	0.10	0.30	0.004	0.012

SMB Suggested Pad Layout

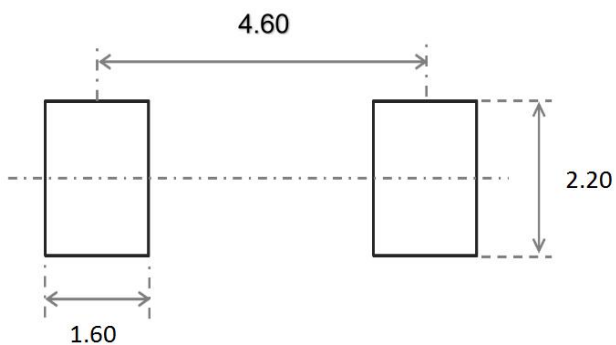

Note:

1. Controlling dimension: in millimeters
2. General tolerance: $\pm 0.05\text{mm}$
3. The pad layout is for reference purposes only

SUPER FAST RECOVERY RECTIFIER DIODE

SMB Tape and Reel

SMB Embossed Carrier Tape

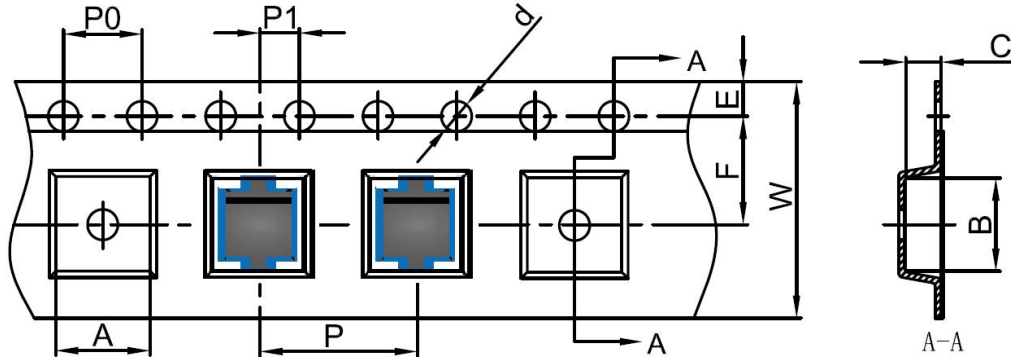

DIMENSIONS ARE IN MILLIMETER										
TYPE	A	B	C	d	E	F	P0	P	P1	W
SMB	4.10	5.50	2.58	Ø1.50	1.75	5.50	4.00	8.00	2.00	12.00
TOLERANCE	±0.1	±0.1	±0.1	±0.1	±0.1	±0.1	±0.1	±0.1	±0.1	±0.1

SMB Tape Leader and Trailer

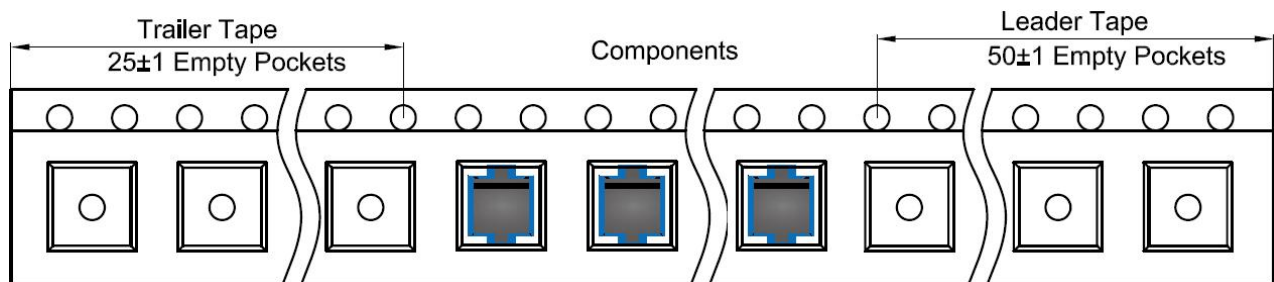

SMB Reel

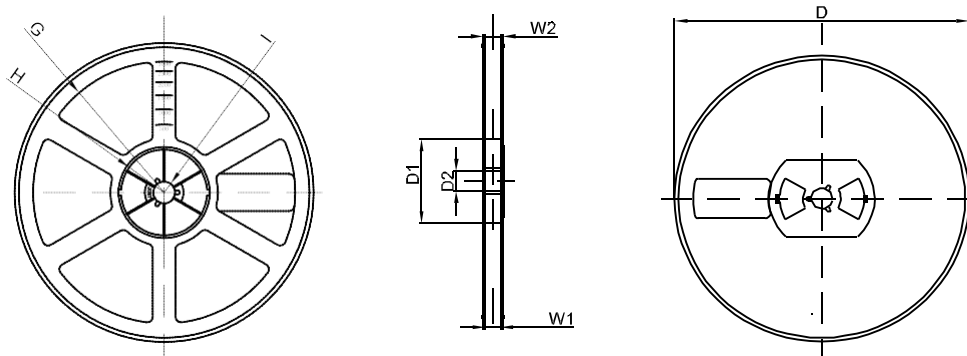

DIMENSIONS ARE IN MILLIMETER								
REEL OPTION	D	D1	D2	G	H	I	W1	W2
13" DIA	Ø330	75.0	13.00	R165	R37.50	R6.50	12.40	17.60
TOLERANCE	±2	±1	±1	±1	±1	±1	±1	±1