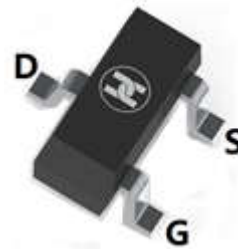
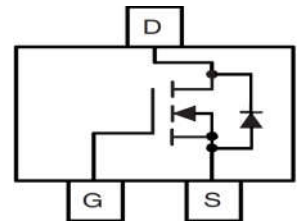

N-CHANNEL POWER MOSFET
FEATURES

- V_{DS} max: 30V
- V_{GS} max: $\pm 12V$
- $R_{DS(on)}$ max: $29m\Omega$ @ $V_{GS}=4.5V$
 $R_{DS(on)}$ max: $37m\Omega$ @ $V_{GS}=2.5V$

SOT-23

Equivalent circuit
MECHANICAL DATA

- Case: SOT-23
- Case material: Molded plastic. UL flammability
- Classification rating: 94V-0
- Terminal: Lead free plating, solderable per MIL-STD-202, method 208
- Weight: 0.008 grams (approximate)

MAXIMUM RATINGS ($T_A = 25^\circ C$ unless otherwise specified)

Parameter	Symbol	Value	Unit
Drain-source voltage	V_{DS}	30	V
Continuous drain current @ $V_{GS}=10V$	I_D	5.0	A
Continuous drain current @ $V_{GS}=10V, T_A=70^\circ C$		4.0	
Pulsed drain current	I_{DM}	25	
Maximum power dissipation	P_D	1.3	W
Maximum power dissipation @ $T_A=70^\circ C$		0.8	
Linear derating factor		0.01	$W/^\circ C$
Gate-to-source voltage	V_{GS}	± 12	V
Junction and storage temperature range	T_J, T_{STG}	-55 ~+ 150	$^\circ C$
Thermal resistance from junction-to-ambient (note 1)	$R_{\theta JA}$	100	$^\circ C/W$
Thermal resistance from junction-to-ambient ($t < 10s$)		99	

N-CHANNEL POWER MOSFET
ELECTRICAL CHARACTERISTICS ($T_A=25^{\circ}\text{C}$ unless otherwise specified)

Parameter	Symbol	Min	Typ	Max	Unit	Conditions
Drain-to-source breakdown voltage	$V_{(BR)DSS}$	30			V	$V_{GS}=0V, I_D=250\mu A$
Breakdown voltage temp. coefficient	$\Delta V_{(BR)DSS}/\Delta T_J$		0.02		V/ $^{\circ}\text{C}$	Reference to $25^{\circ}\text{C}, I_D=1\text{mA}$
Static drain-to-source on-resistance (note 2)	$R_{DS(on)}$		22	29	m Ω	$V_{GS}=4.5V, I_D=5.0A$
			27	37		$V_{GS}=2.5V, I_D=4.0A$
Gate threshold voltage	$V_{GS(th)}$	0.5	0.8	1.1	V	$V_{DS}=V_{GS}, I_D=10\mu A$
Drain-to-source leakage current	I_{DSS}			1.0	μA	$V_{DS}=24V, V_{GS}=0V$
				150		$V_{DS}=24V, V_{GS}=0V, T_J=125^{\circ}\text{C}$
Gate-to-source forward leakage	I_{GSS}			100	nA	$V_{GS}=12V$
Gate-to-source reverse leakage				-100		$V_{GS}=-12V$
Internal gate resistance	R_G		1.7		Ω	
Forward transconductance	g_{fs}	19			S	$V_{DS}=10V, I_D=5.0A$
Total gate charge	Q_g		6.8		nC	$I_D=5.0A, V_{DS}=15V, V_{GS}=4.5V$ (note 2)
Gate-to-source charge	Q_{gs}		0.3			
Gate-to-drain ("Miller") charge	Q_{gd}		2.4			
Turn-on delay time	$t_{d(on)}$		4.2		ns	$V_{DD}=15V, I_D=1.0A, R_G=6.8\Omega$ $V_{GS}=4.5V$ (note 2)
Rise time	t_r		5.6			
Turn-off delay time	$t_{d(off)}$		22			
Fall time	t_f		9.1			
Input capacitance	C_{iss}		650		pF	$V_{GS}=0V, V_{DS}=25V$ $f=1.0\text{MHz}$
Output capacitance	C_{oss}		65			
Reverse transfer capacitance	C_{rss}		46			
Continuous source current (body diode)	I_S			1.3	A	Equivalent circuit is showing the integral reverse p-n junction diode
Pulsed source current (body diode, note 1)	I_{SM}			25		
Diode forward voltage (note 2)	V_{SD}			1.2	V	$T_J=25^{\circ}\text{C}, I_S=5.0A, V_{GS}=0V$
Reverse recovery time (note 2)	t_{rr}		10	15	ns	$T_J=25^{\circ}\text{C}, V_R=15V, I_F=1.3A$
Reverse recovery charge (note 2)	Q_{rr}		3.8	5.7	nC	$di/dt=100A/\mu s$

Notes :

- 1.Repetitive rating; pulse width limited by max. junction temperature.
- 2.Pulse width $\leq 400\mu s$; duty cycle $\leq 2\%$.
- 3.Surface mounted on 1 in² Cu board

N-CHANNEL POWER MOSFET

TYPICAL CHARACTERISTICS

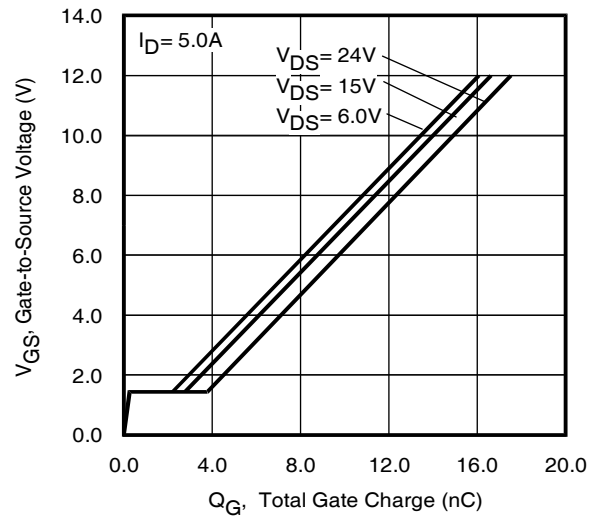
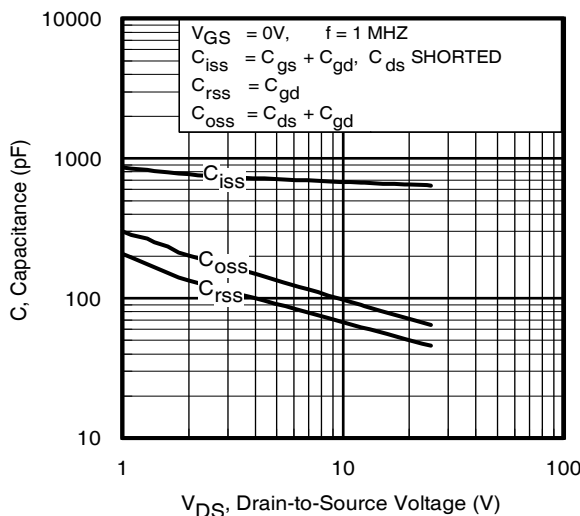
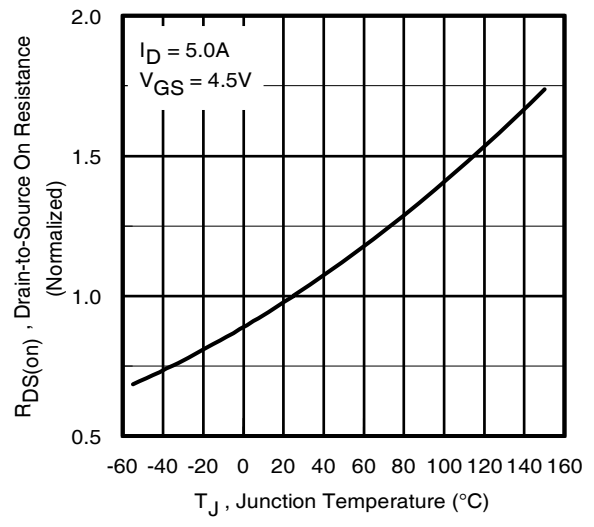
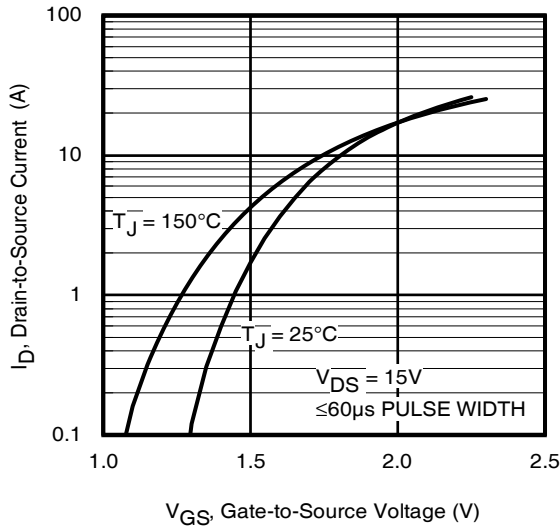
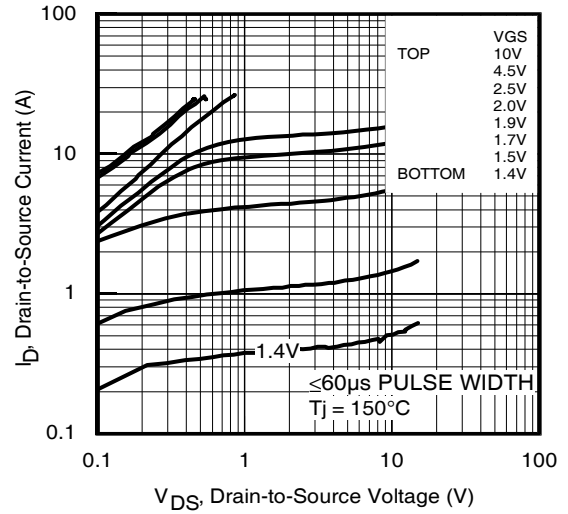
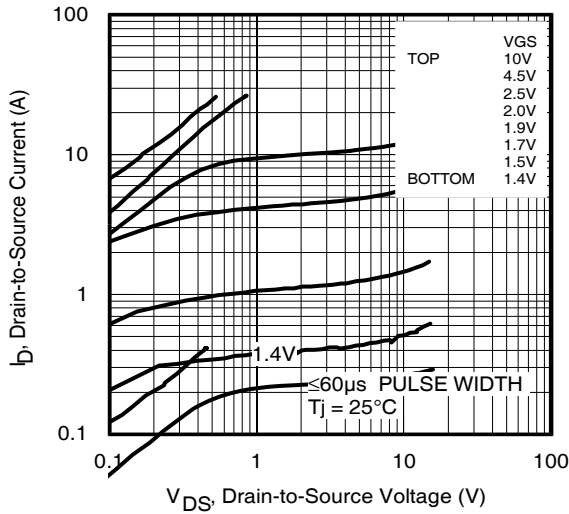

N-CHANNEL POWER MOSFET

TYPICAL CHARACTERISTICS (continued)

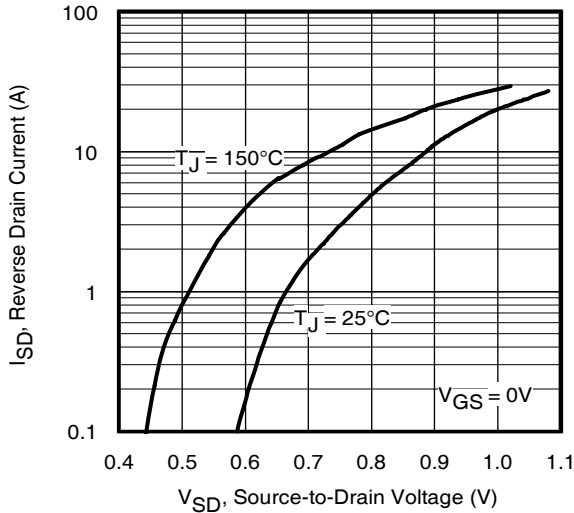

Fig 7. Typical Source-Drain Diode Forward Voltage

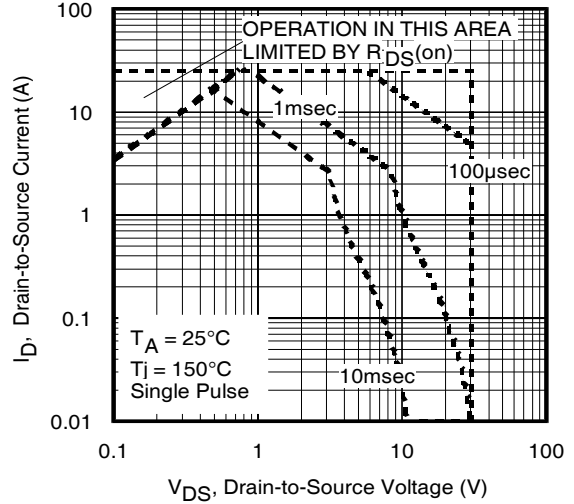

Fig 8. Maximum Safe Operating Area

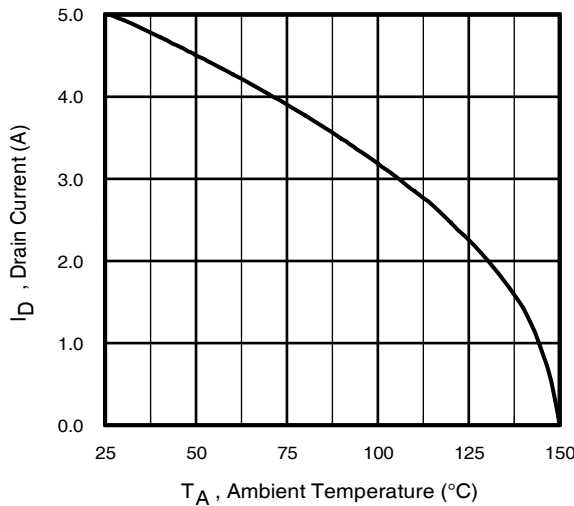

Fig 9. Maximum Drain Current Vs. Ambient Temperature

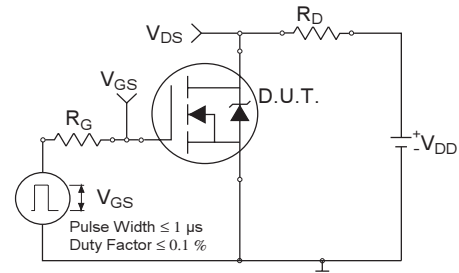

Fig 10a. Switching Time Test Circuit

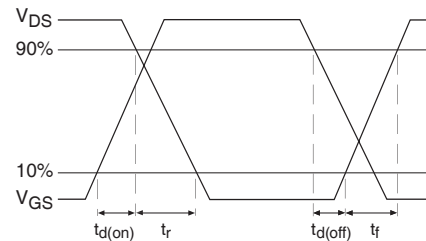

Fig 10b. Switching Time Waveforms

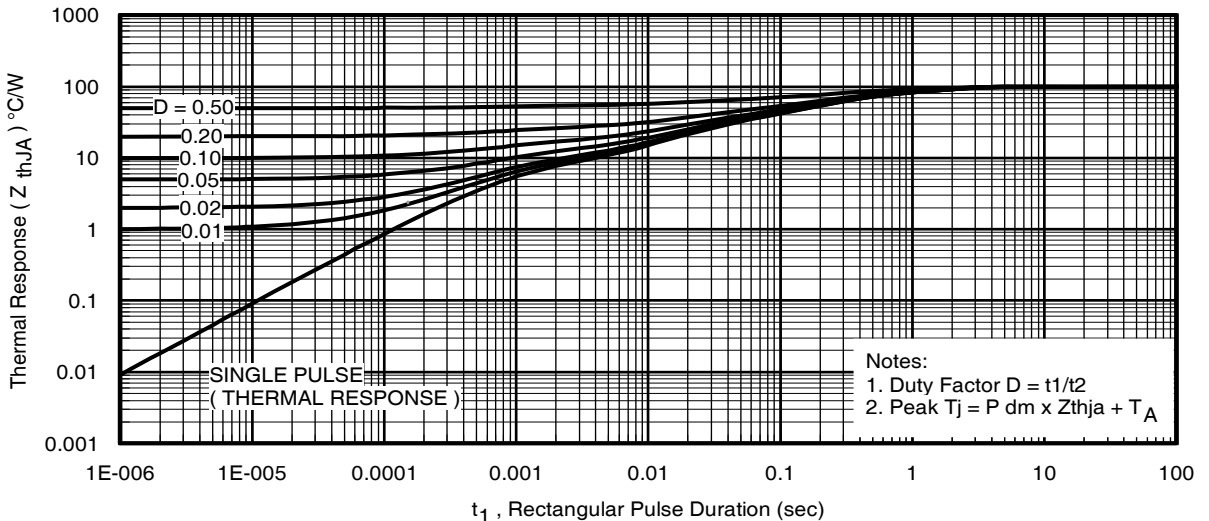
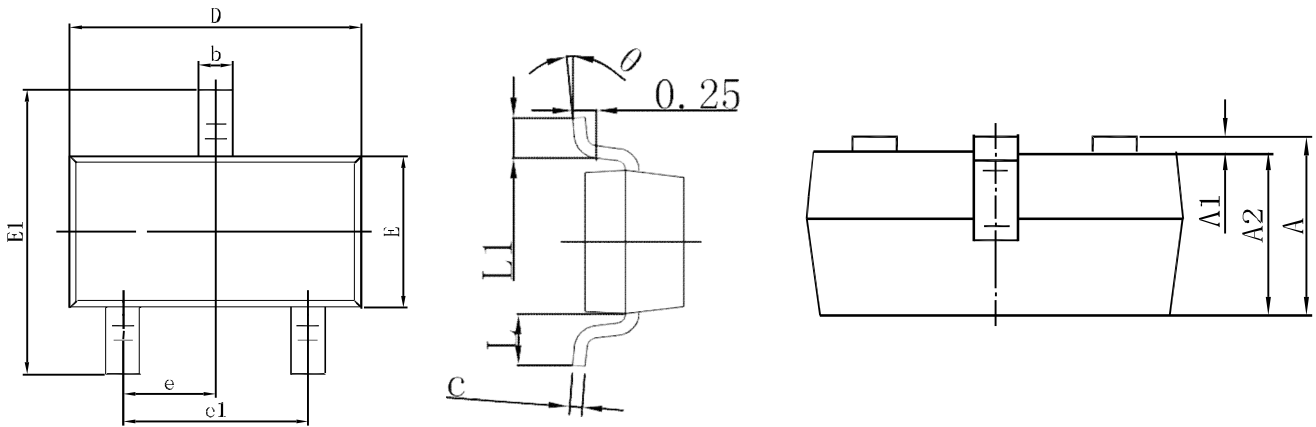
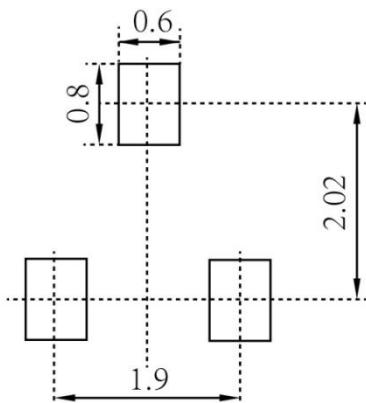

Fig 11. Typical Effective Transient Thermal Impedance, Junction-to-Ambient

N-CHANNEL POWER MOSFET
SOT-23 PACKAGE OUTLINE DIMENSIONS

Symbol	Dimensions In Millimeters		Dimensions In Inches	
	Min.	Max.	Min.	Max.
A	0.900	1.150	0.035	0.045
A1	0.000	0.100	0.000	0.004
A2	0.900	1.050	0.035	0.041
b	0.300	0.500	0.012	0.020
c	0.080	0.150	0.003	0.006
D	2.800	3.000	0.110	0.118
E	1.200	1.400	0.047	0.055
E1	2.250	2.550	0.089	0.100
e	0.950 TYP		0.037 TYP	
e1	1.800	2.000	0.071	0.079
L	0.550 REF		0.022 REF	
L1	0.300	0.500	0.012	0.020
θ	0°	8°	0°	8°

SOT-23 SUGGESTED PAD LAYOUT

Note:

1. Controlling dimension: in millimeters
2. General tolerance: $\pm 0.05\text{mm}$
3. The pad layout is for reference purposes only

N-CHANNEL POWER MOSFET

SOT-23 TAPE AND REEL

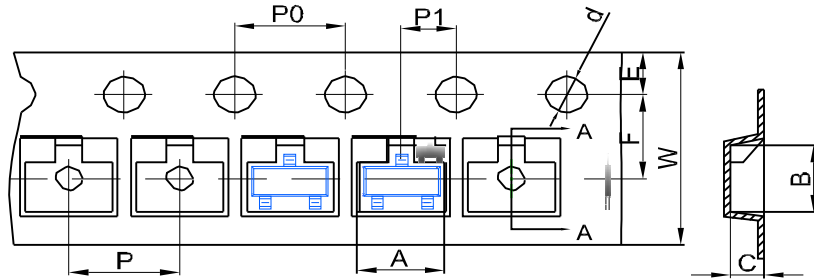
SOT-23 Embossed Carrier Tape



DIMENSIONS ARE IN MILLIMETER										
TYPE	A	B	C	d	E	F	P0	P	P1	W
SOT-23	3.15	2.77	1.22	Ø1.50	1.75	3.50	4.00	4.00	2.00	8.00
TOLERANCE	±0.1	±0.1	±0.1	±0.1	±0.1	±0.1	±0.1	±0.1	±0.1	±0.1

SOT-23 Tape Leader and Trailer

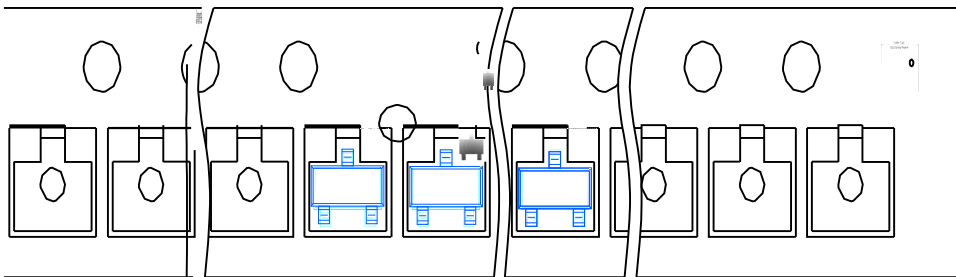

SOT-23 Reel

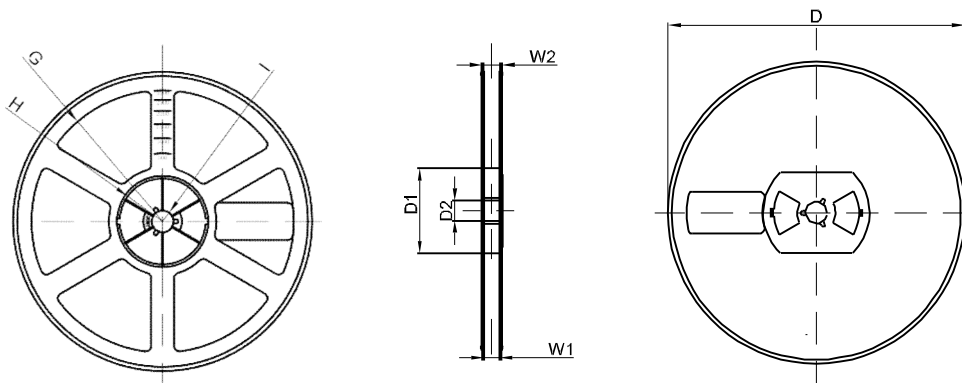

DIMENSIONS ARE IN MILLIMETER								
REEL OPTION	D	D1	D2	G	H	I	W1	W2
7" DIA	Ø178	54.40	13.00	R78	R25.60	R6.50	9.50	12.30
TOLERANCE	±2	±1	±1	±1	±1	±1	±1	±1