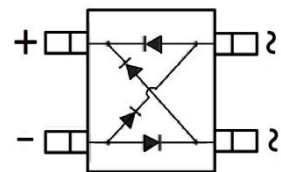

BRIDGE RECTIFIER
FEATURES

- Low Reverse voltage leakage current
- Glass Passivated Die Construction
- Low Forward Voltage Drop
- High forward surge current capability
- Small Surface Mount device

MB-S
MECHANICAL DATA

- Case: MB-S
- Case Material: Molded Plastic. UL flammability
- Classification Rating: 94V-0
- Moisture Sensitivity: Level 1 per J-STD-020
- Weight: 0.22 grams (approximate)

MAXIMUM RATINGS (T_A = 25°C unless otherwise noted)

Parameter	Symbol	Value	Unit
Repetitive peak reverse voltage	V _{RRM}	1000	V
DC Reverse Voltage	V _R	1000	V
RMS Reverse Voltage	V _{RMS}	700	V
Mean rectifying current	I _F	0.5/0.8	A
Non-Repetitive Peak Forward Surge Current @ t = 8.3 ms	I _{FSM}	30	A
Thermal Resistance From Junction To Ambient	R _{θJA}	90	°C/W
Junction Temperature	T _J	-55 ~+150	°C
Storage Temperature	T _{STG}	-55 ~+150	°C

ELECTRICAL CHARACTERISTICS (T_A = 25°C unless otherwise specified)

Parameter	Symbol	Min	Max	Unit	Conditions
Forward voltage	V _F		1.0	V	I _F =0.5A
Forward voltage	V _F		1.1	V	I _F =0.8A
Reverse current T=25°C	I _R		5	uA	V _R =1000V
Reverse current T=125°C	I _R		40	uA	V _R =1000V
Junction capacitance	C _J		13	pF	V=4V _{DC} ,f=1MH

BRIDGE RECTIFIER

Typical Characteristics

Fig.1- Output Current Derating Curve

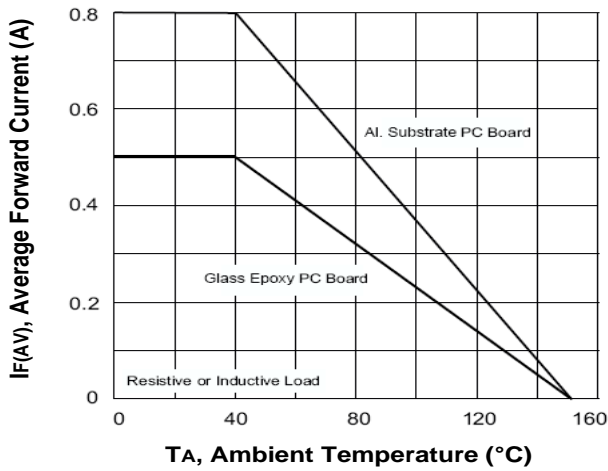

Fig.2-Max. Non-repetitive Peak Forward Surge Current per leg

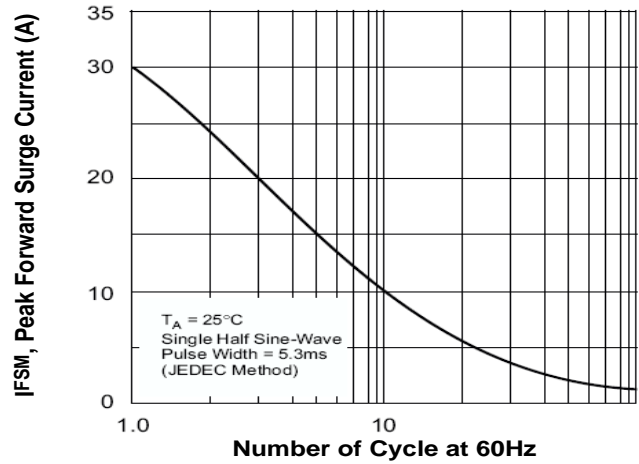

Fig.3-Typical Instantaneous Forward Characteristic per leg

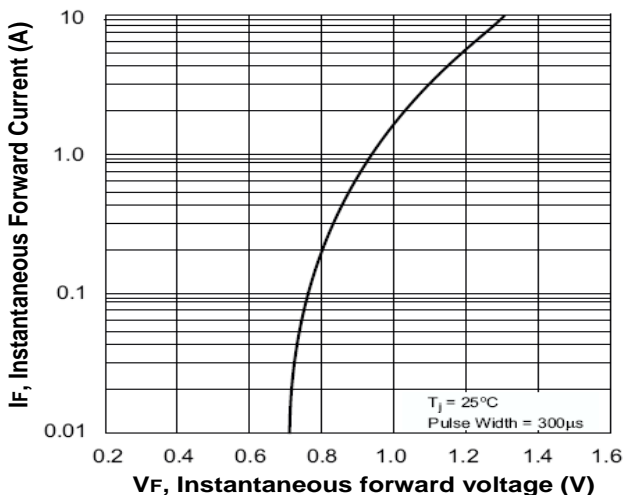

Fig.4-Typical Reverse Characteristics per leg

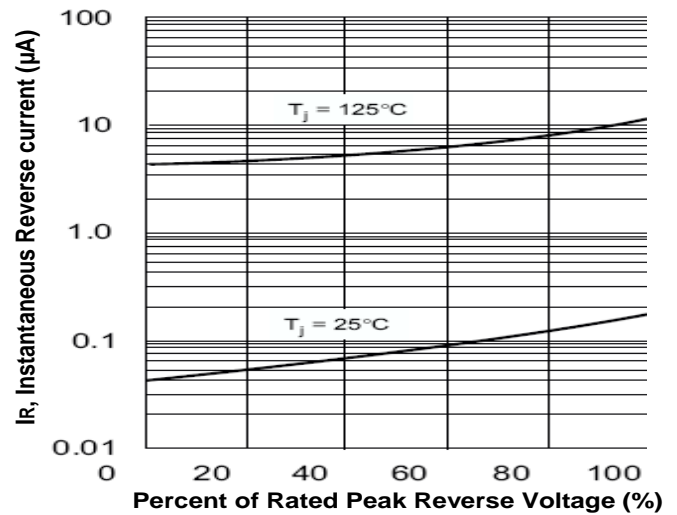
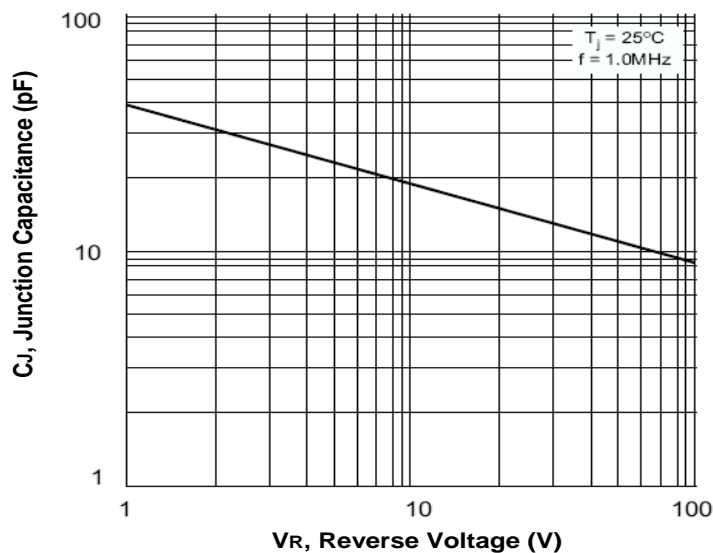
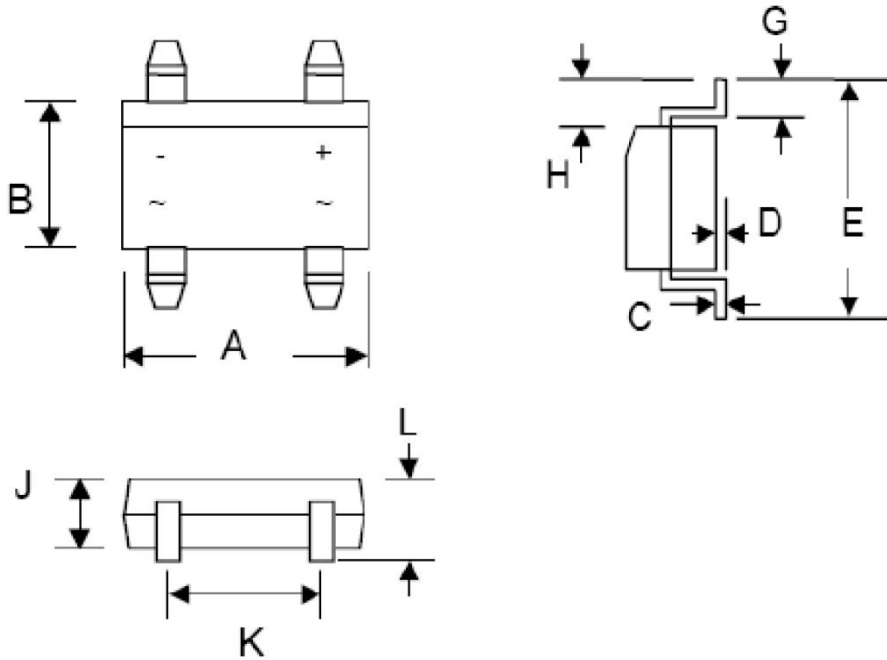
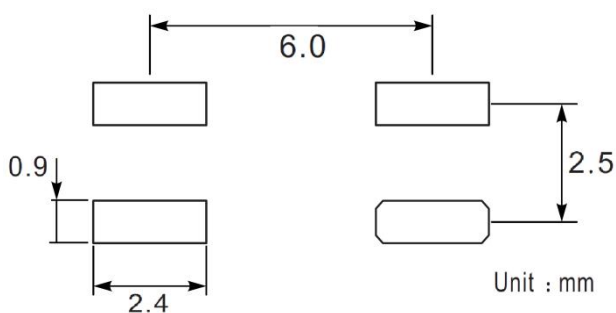

Fig.5-Typical Junction Capacitance



BRIDGE RECTIFIER
MB-S Package Outline Dimensions

Symbol	Dimensions In Millimeters		Dimensions In Inches	
	Min.	Max.	Min.	Max.
A	4.50	4.90	0.177	0.193
B	3.80	4.20	0.150	0.165
C	0.15	0.35	0.006	0.014
D	-----	0.20	—	0.008
E	-----	7.00	—	0.276
G	0.70	1.10	0.028	0.043
H	1.30	1.70	0.051	0.067
J	2.30	2.70	0.091	0.106
K	2.30	2.70	0.091	0.106
L	—	3.00	—	0.118

MB-S Suggested Pad Layout

Note:

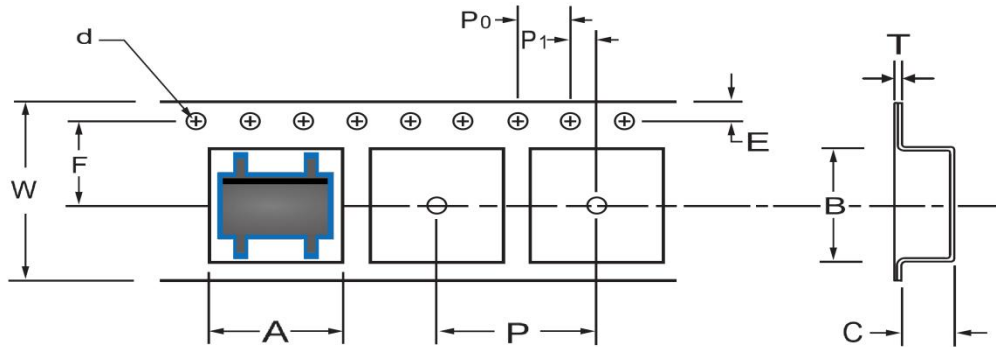
1. Controlling dimension: in millimeters
2. General tolerance: $\pm 0.05\text{mm}$
3. The pad layout is for reference purposes only

BRIDGE RECTIFIER
MB-S Tape and Reel
MB-S Embossed Carrier Tape

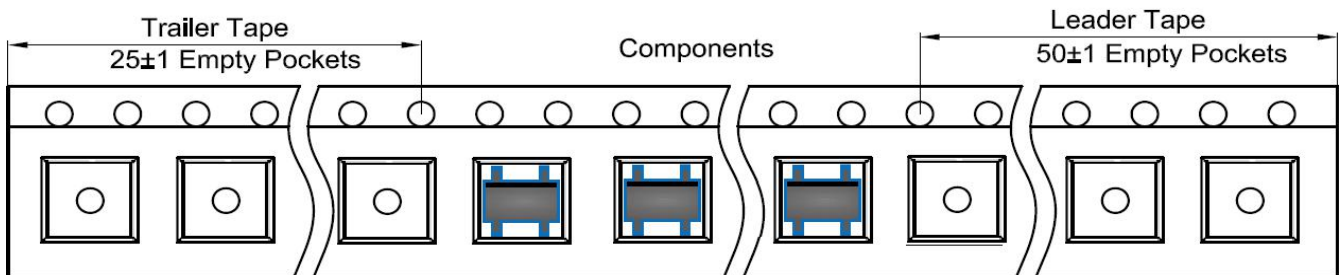
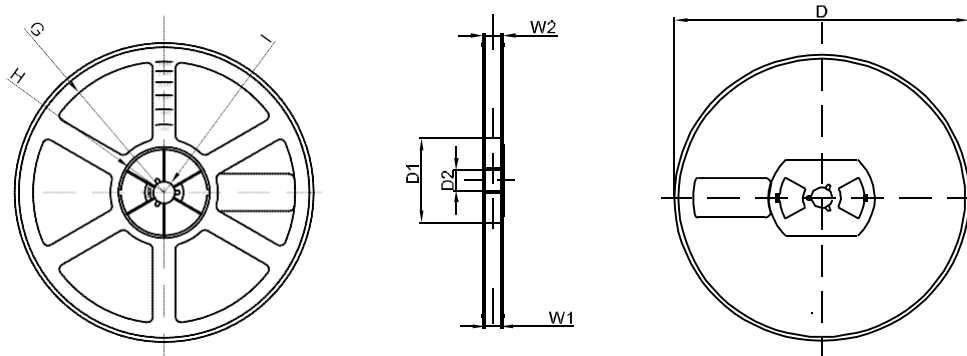
DIMENSIONS ARE IN MILLIMETER										
TYPE	A	B	C	d	E	F	P0	P	P1	W
MB-S	5.00	7.24	3.33	Ø1.50	1.75	5.50	4.00	8.00	2.00	12.00
TOLERANCE	±0.1	±0.1	±0.1	±0.1	±0.1	±0.1	±0.1	±0.1	±0.1	±0.1

MB-S Tape Leader and Trailer

MB-S Reel

DIMENSIONS ARE IN MILLIMETER								
REEL OPTION	D	D1	D2	G	H	I	W1	W2
13" DIA	Ø330	75.0	13.00	R165	R37.50	R6.50	12.40	17.60
TOLERANCE	±2	±1	±1	±1	±1	±1	±1	±1