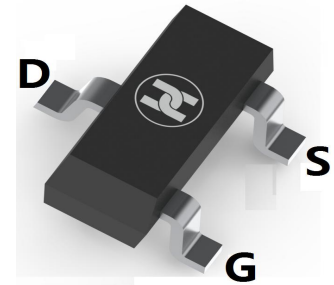
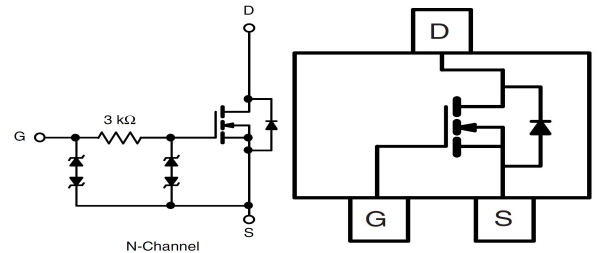

LOW VOLTAGE MOSFET (N-CHANNEL)
FEATURES

- $V_{DS}=20V, R_{DS(ON)} \leq 33m\Omega @ V_{GS}=4.5V, I_D=4.9A$
- Ultra Low on-resistance
- For Low power DC to DC converter application
- For Load switch application
- Surface Mount device

SOT-23

MAXIMUM RATINGS (T_A = 25°C unless otherwise noted)

Parameter	Symbol	Value	Unit
Drain-source voltage	V_{DS}	20	V
Gate-source voltage	V_{GS}	± 12	V
Continuous drain current	I_D	4.9	A
Pulsed drain current (Note 1)	I_{DM}	15	A
Continuous Source-Drain Diode current	I_S	1	A
Power dissipation	P_D	1.25	W
Thermal resistance from Junction to ambient	$R_{\theta JA}$	100	°C/W
Junction temperature	T_J	150	°C
Storage temperature	T_{STG}	-55 ~ +150	°C

ELECTRICAL CHARACTERISTICS (T_A = 25°C unless otherwise specified)

Parameter	Symbol	Min	Typ	Max	Unit	Conditions
Drain-Source breakdown voltage	$V_{(BR)DSS}$	20			V	$V_{GS}=0V, I_D=250\mu A$
Zero gate voltage drain current	I_{DSS}			1	μA	$V_{DS}=20V, V_{GS}=0V$
Gate-body leakage current	I_{GSS}			± 150	nA	$V_{DS}=0V, V_{GS}=\pm 4.5V$
Gate-threshold voltage (note 1)	$V_{GS(th)}$	0.45		0.95	V	$V_{DS}=V_{GS}, I_D=250\mu A$
Drain-source on-resistance (note 1)	$R_{DS(ON)}$		27	33	m Ω	$V_{GS}=4.5V, I_D=5A$
			33	40	m Ω	$V_{GS}=2.5V, I_D=4.5A$
			42	51	m Ω	$V_{GS}=1.8V, I_D=4.0A$
Forward transconductance (note 1)	g_{FS}		40		S	$V_{DS}=15V, I_D=5A$
Total Gate Charge	Q_g		11.0	14.0	nC	$V_{DS}=10V, V_{GS}=4.5V, I_D=5A$
Gate-Source Charge	Q_{gs}		1.5		nC	
Gate-Drain Charge	Q_{gd}		2.1		nC	
Turn-on delay time	$t_{d(on)}$		0.53	0.8	nS	$V_{DD}=10V, V_{GS}=4.5V, R_{GEN}=6\Omega, I_D=1A, R_L=10\Omega$
Turn-on rise time	t_r		1.4	2.2	nS	
Turn-off delay time	$t_{d(off)}$		13.5	20	nS	
Turn-off fall time	t_f		5.9	9	nS	
Source-Drain Reverse Recovery	t_{rr}		13	25	nS	$I_F=1A, di/dt=100A/\mu s$
Diode forward voltage (note 1)	V_{SD}		0.8	1.2	V	$I_S=1A, V_{GS}=0V$

Note:1. Pulse test: Pulse width $\leq 300\mu s$, Duty cycle $\leq 2\%$.

LOW VOLTAGE MOSFET (N-CHANNEL)

Typical Characteristics

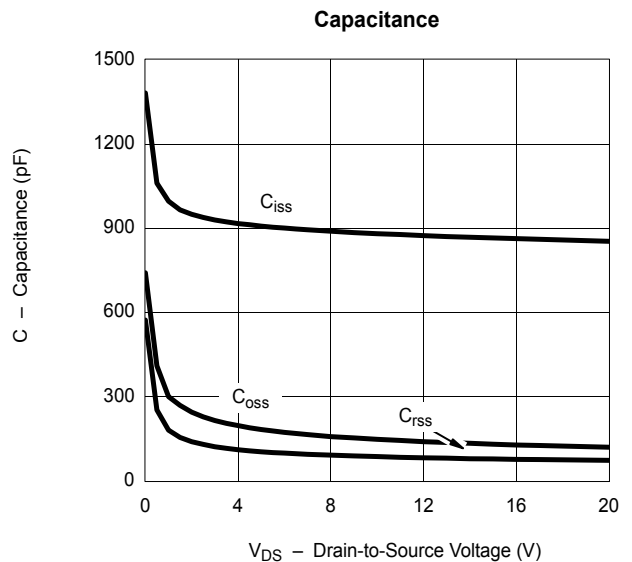
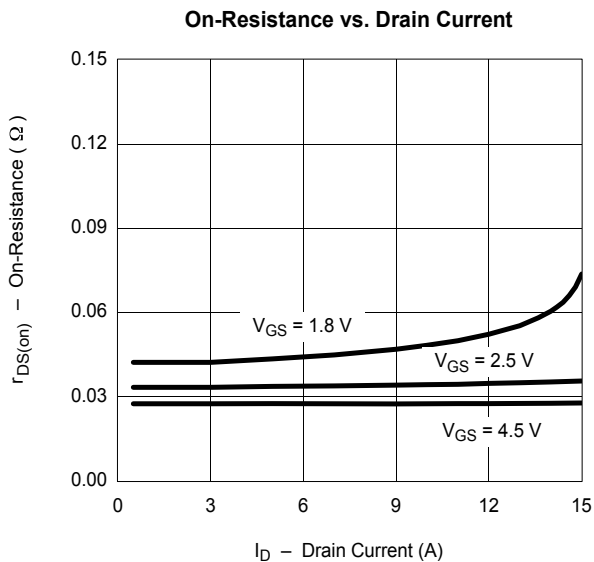
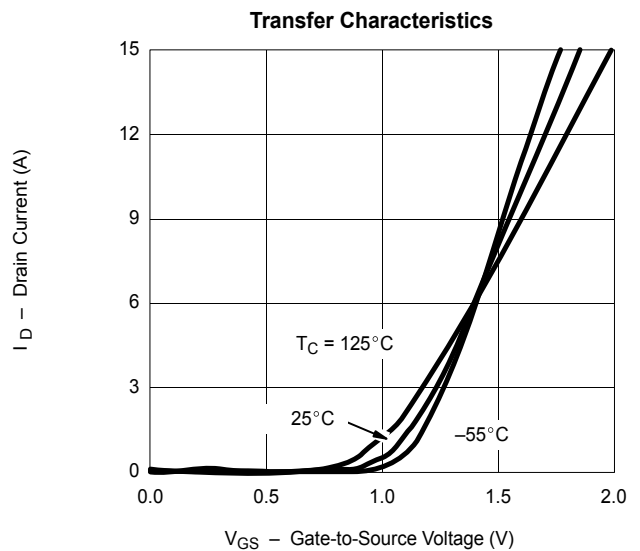
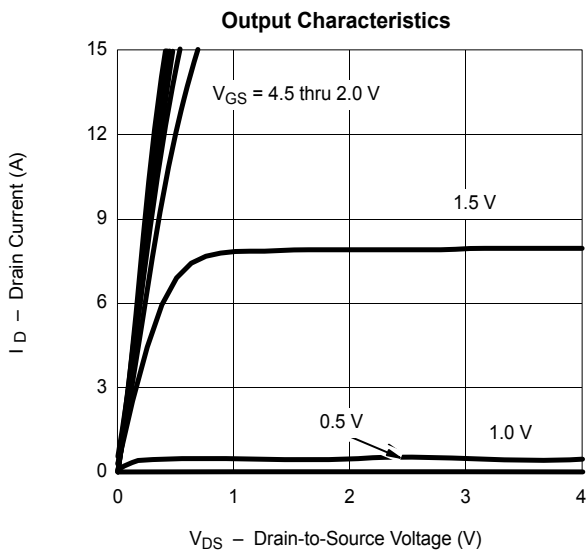
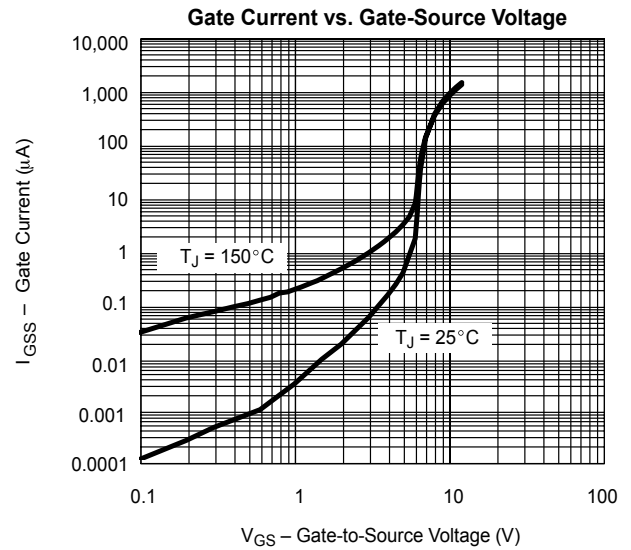
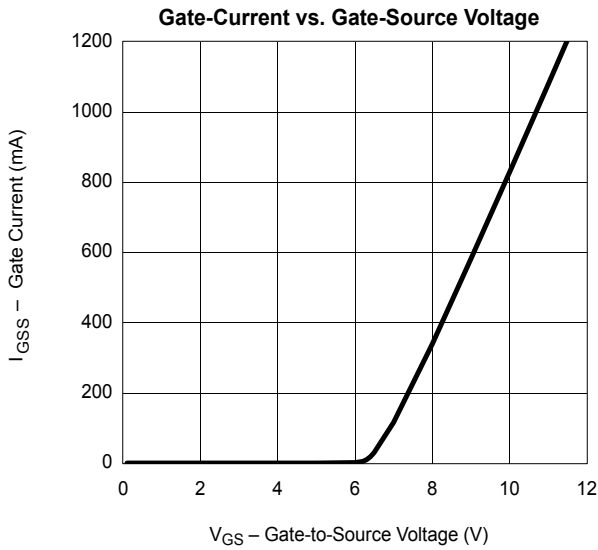

LOW VOLTAGE MOSFET (N-CHANNEL)

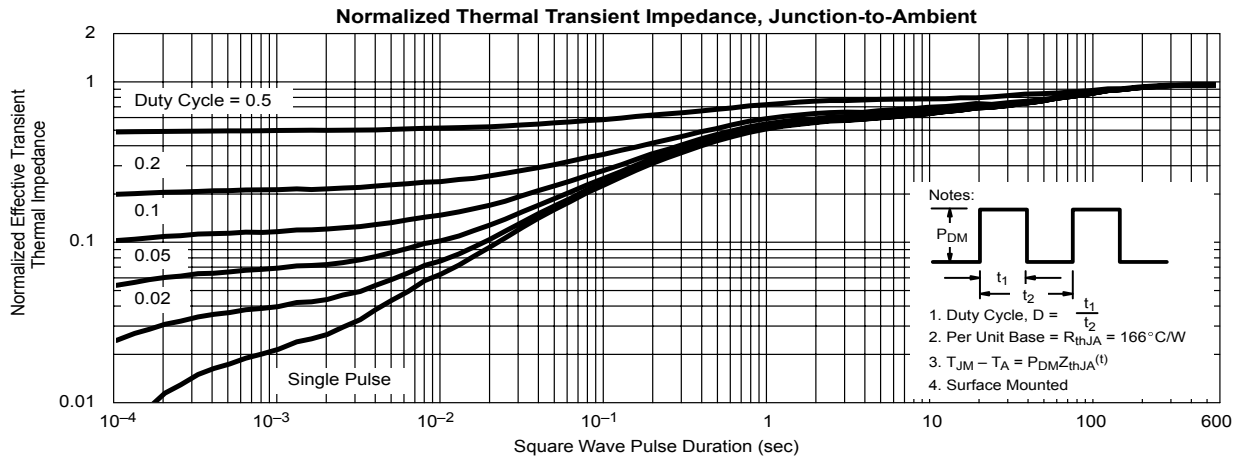
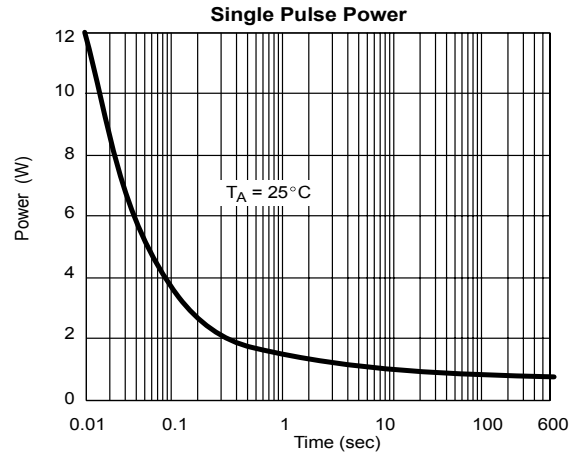
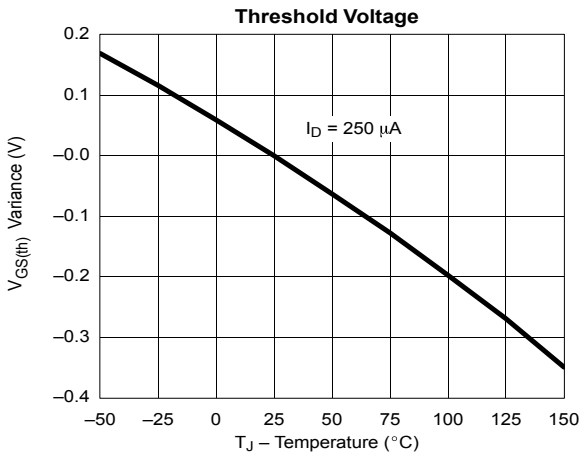
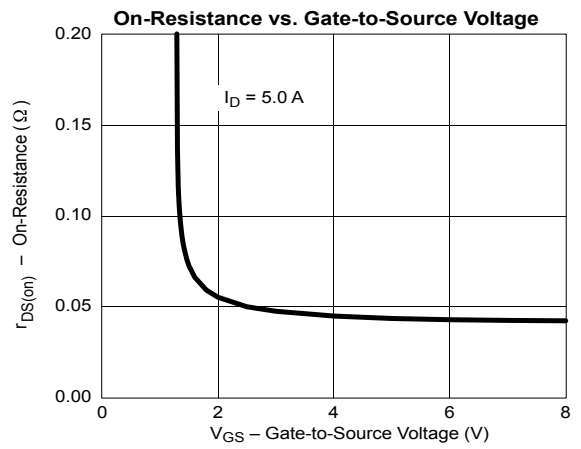
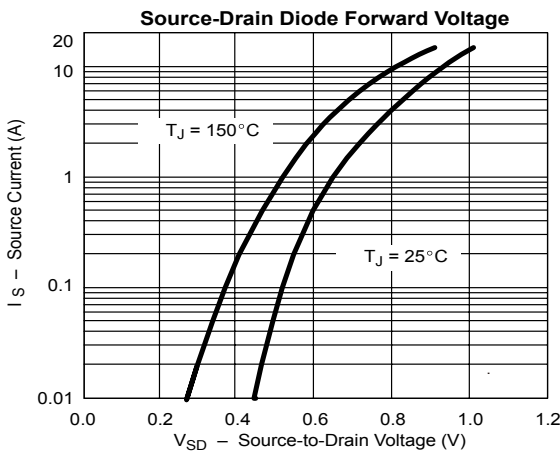
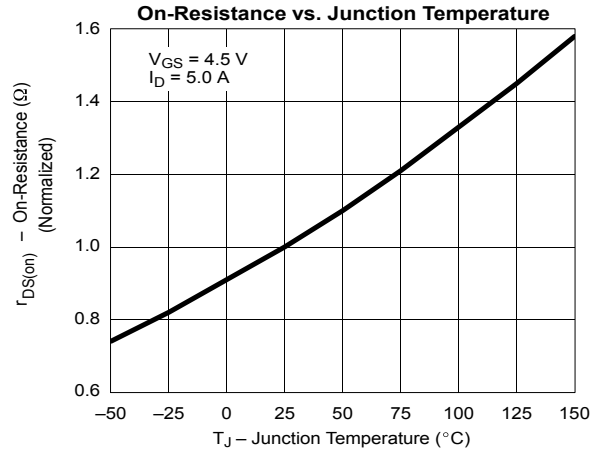
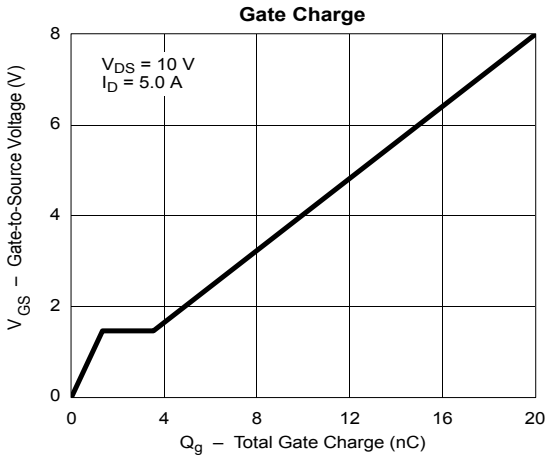

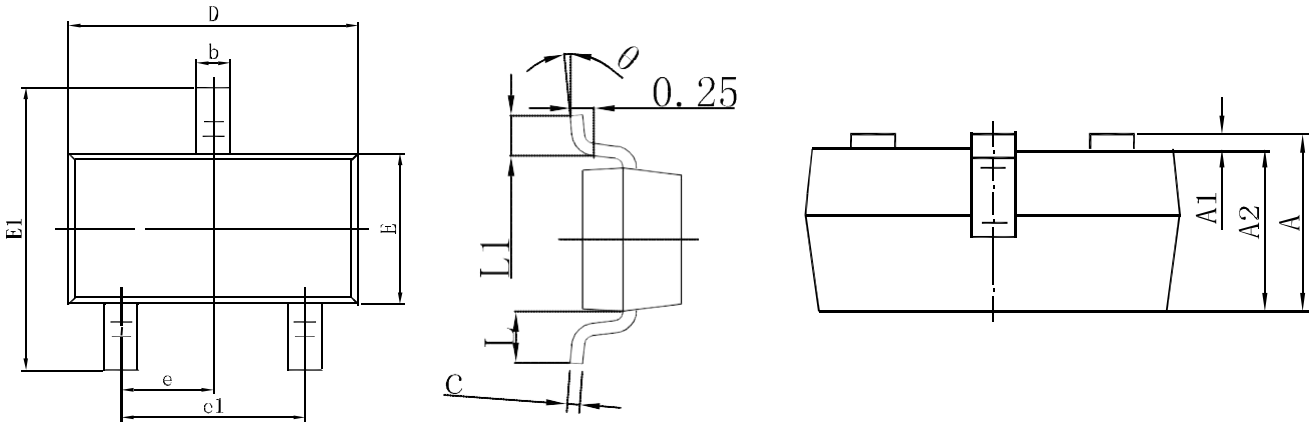
LOW VOLTAGE MOSFET (N-CHANNEL)
SOT-23 Package Outline Dimensions

Symbol	Dimensions In Millimeters		Dimensions In Inches	
	Min.	Max.	Min.	Max.
A	0.900	1.150	0.035	0.045
A1	0.000	0.100	0.000	0.004
A2	0.900	1.050	0.035	0.041
b	0.300	0.500	0.012	0.020
c	0.080	0.150	0.003	0.006
D	2.800	3.000	0.110	0.118
E	1.200	1.400	0.047	0.055
E1	2.250	2.550	0.089	0.100
e	0.950 TYP		0.037 TYP	
e1	1.800	2.000	0.071	0.079
L	0.550 REF		0.022 REF	
L1	0.300	0.500	0.012	0.020
θ	0°	8°	0°	8°

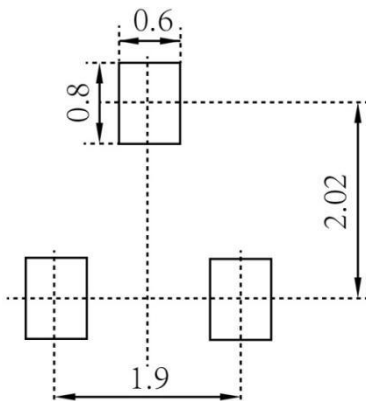
SOT-23 Suggested Pad Layout

Note:

1. Controlling dimension: in millimeters
2. General tolerance: $\pm 0.05\text{mm}$
3. The pad layout is for reference purposes only

LOW VOLTAGE MOSFET (N-CHANNEL)

SOT-23 Tape and Reel

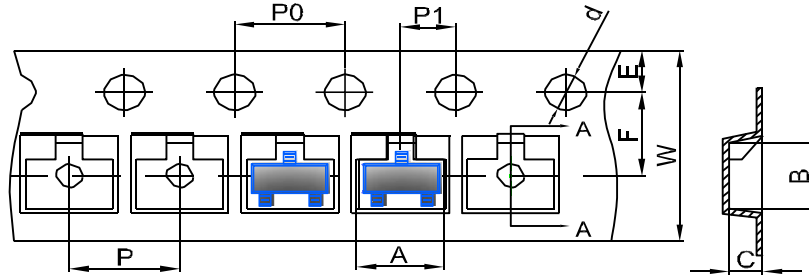
SOT-23 Embossed Carrier Tape



DIMENSIONS ARE IN MILLIMETER										
TYPE	A	B	C	d	E	F	P0	P	P1	W
SOT-23	3.15	2.77	1.22	Ø1.50	1.75	3.50	4.00	4.00	2.00	8.00
TOLERANCE	±0.1	±0.1	±0.1	±0.1	±0.1	±0.1	±0.1	±0.1	±0.1	±0.1

SOT-23 Tape Leader and Trailer

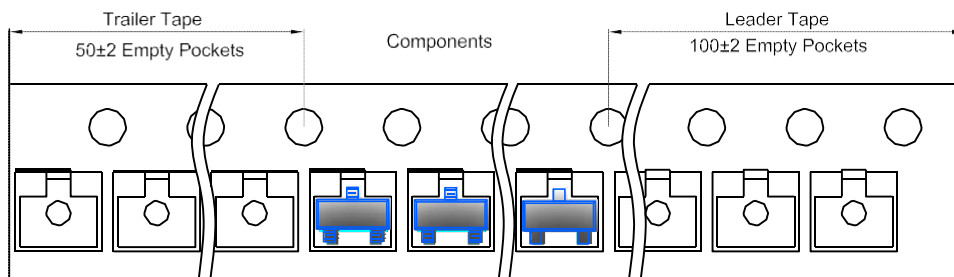

SOT-23 Reel

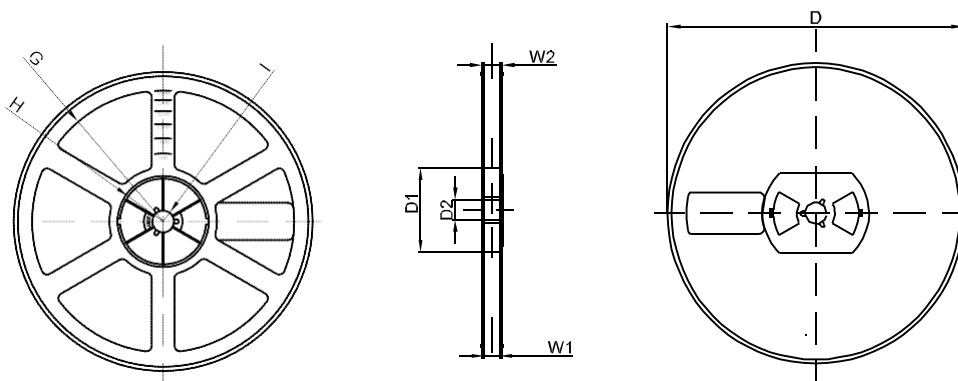

DIMENSIONS ARE IN MILLIMETER								
REEL OPTION	D	D1	D2	G	H	I	W1	W2
7" DIA	Ø178	54.40	13.00	R78	R25.60	R6.50	9.50	12.30
TOLERANCE	±2	±1	±1	±1	±1	±1	±1	±1