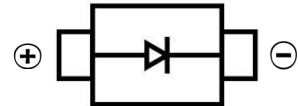

SCHOTTKY BARRIER DIODE
FEATURES

- Small Surface Mount device
- Built-in strain relief
- Super low forward voltage drop

SMA

MECHANICAL DATA

- Case: SMA(DO-214AC)
- Case Material: Molded Plastic. UL flammability
- Classification Rating: 94V-0
- Weight: 0.065 grams (approximate)

MAXIMUM RATINGS (T_A = 25°C unless otherwise noted)

Parameter	Symbol	Value	Unit
Repetitive peak reverse voltage	V _{RRM}	60	V
DC Reverse Voltage	V _R	60	V
RMS Reverse Voltage	V _{RMS}	42	V
Non-Repetitive Peak Forward Surge Current @ t = 8.3 ms	I _{FSM}	80	A
Mean rectifying current	I _F	3	A
Thermal Resistance From Junction To Ambient	R _{θJA}	85	°C/W
Junction Temperature	T _J	150	°C
Storage Temperature	T _{STG}	-55 ~+175	°C

ELECTRICAL CHARACTERISTICS (T_A = 25°C unless otherwise specified)

Parameter	Symbol	Min	Max	Unit	Conditions
Forward voltage	V _F		0.70	V	I _F =3A
Reverse current T=25°C	I _R		0.50	mA	V _R =60V
Reverse current T=100°C	I _R		20	mA	V _R =60V
Junction capacitance	C _J		160	pF	V=4V, f=1MH

SCHOTTKY BARRIER DIODE

Typical Characteristics

FIG.1 FORWARD CURRENT DERATING CURVE

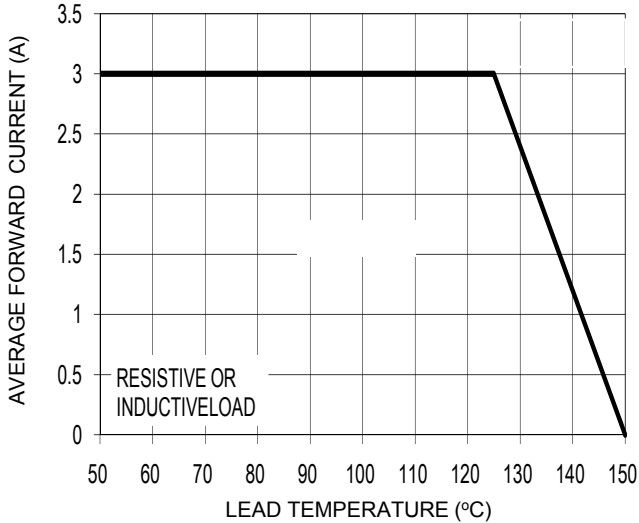

FIG. 2 MAXIMUM NON-REPETITIVE FORWARD SURGE CURRENT

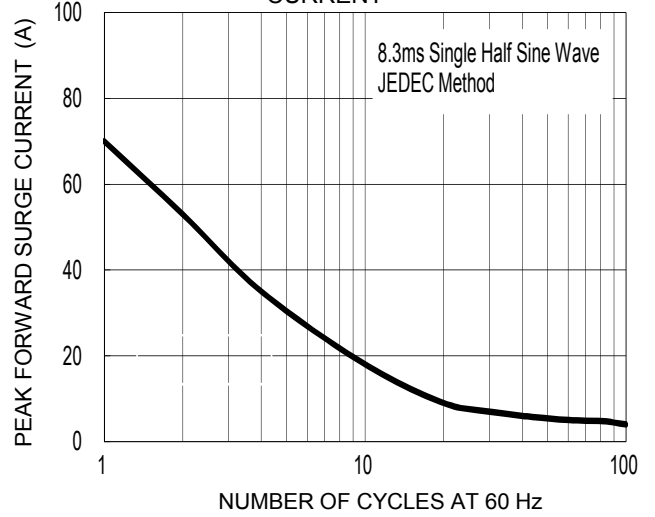

FIG. 3 TYPICAL FORWARD CHARACTERISTICS

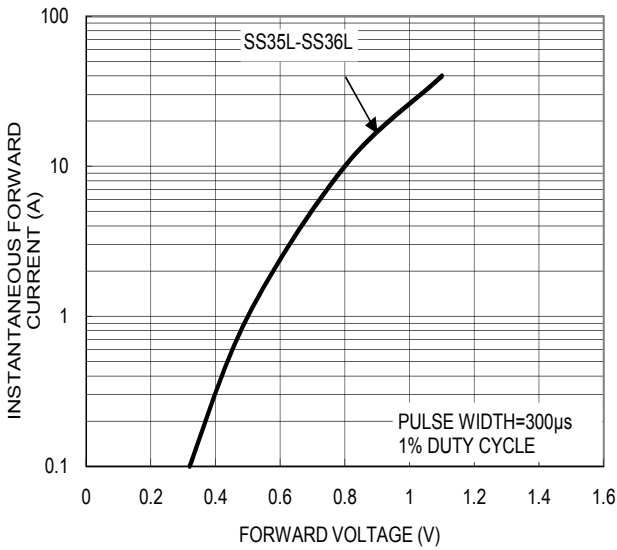

FIG. 4 TYPICAL REVERSE CHARACTERISTICS

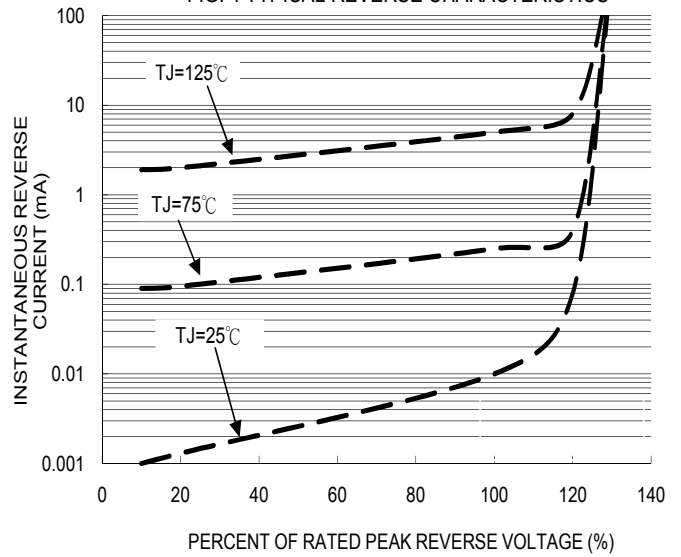

FIG. 5 TYPICAL JUNCTION CAPACITANCE

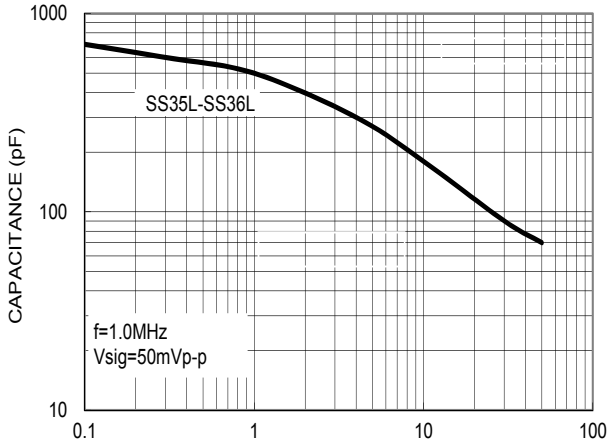
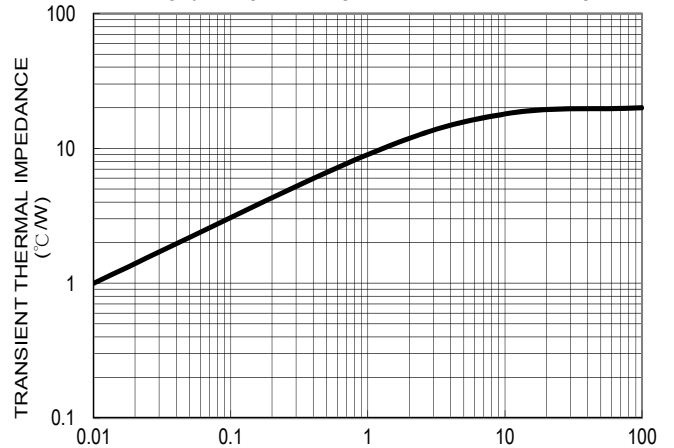
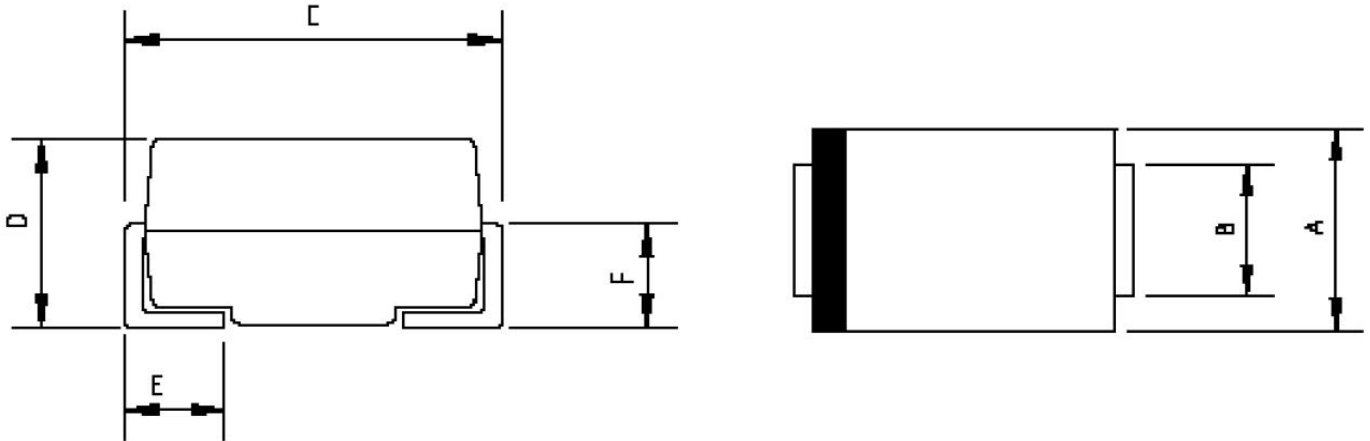
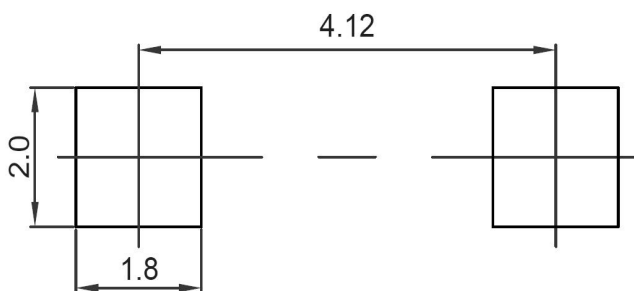

FIG. 6 TYPICAL TRANSIENT THERMAL IMPEDANCE



SCHOTTKY BARRIER DIODE
SMA Package Outline Dimensions

Symbol	Dimensions In Millimeters		Dimensions In Inches	
	Min.	Max.	Min.	Max.
A	2.20	2.80	0.086	0.110
B	1.30	1.70	0.051	0.067
C	4.70	5.30	0.185	0.209
D	1.70	2.55	0.067	0.100
E	0.90	1.50	0.035	0.059
F	0.90	1.50	0.035	0.059

SMA Suggested Pad Layout

Note:

1. Controlling dimension: in millimeters
2. General tolerance: $\pm 0.05\text{mm}$
3. The pad layout is for reference purposes only

SCHOTTKY BARRIER DIODE
SMA Tape and Reel
SMA Embossed Carrier Tape

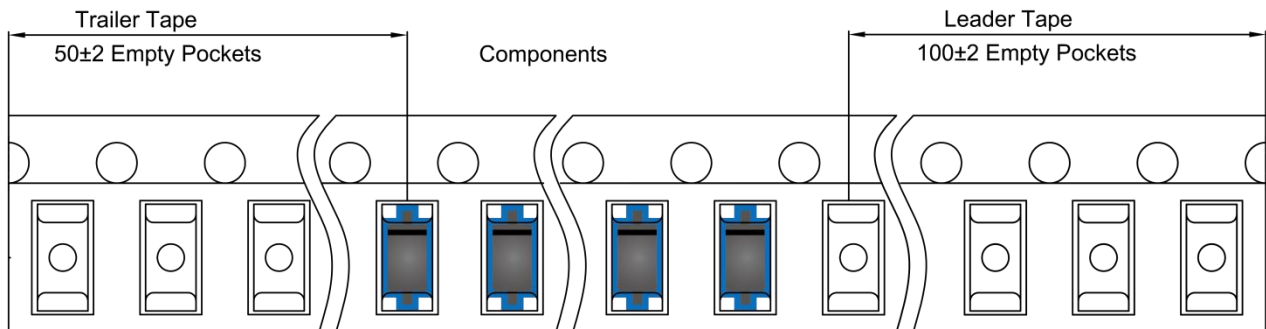
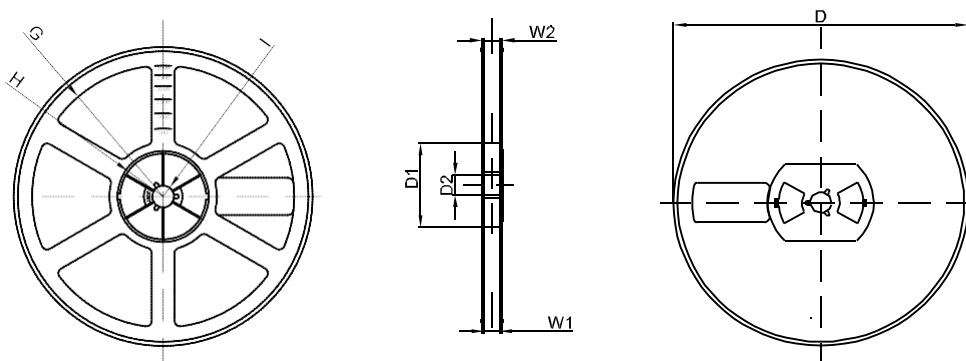
DIMENSIONS ARE IN MILLIMETER										
TYPE	A	B	C	d	E	F	P0	P	P1	W
SMA	2.89	5.35	2.68	Ø1.50	1.75	5.50	4.00	4.00	2.00	12.00
TOLERANCE	±0.1	±0.1	±0.1	±0.1	±0.1	±0.1	±0.1	±0.1	±0.1	±0.1

SMA Tape Leader and Trailer

SMA Reel

DIMENSIONS ARE IN MILLIMETER								
REEL OPTION	D	D1	D2	G	H	I	W1	W2
7" DIA	Ø178	54.40	13.00	R78	R25.60	R6.50	12.40	17.60
TOLERANCE	±2	±1	±1	±1	±1	±1	±1	±1