



厦门华联半导体科技有限公司

Xiamen Hualian Semiconductor Technology Co., Ltd.

---

# 产品规格书

## SPECIFICATION

---

产品名称：高速逻辑门输出型光耦合器

**DESCRIPTION: High Speed Logic Gate Opto-coupler**

产品型号：HPL6M237

**PART NO.: HPL6M237**

拟制 Prepared	审核 Verified	批准 Approved

电话 Tel: 86-0592-2950777

传真 Fax: 86-0592-6037471

网址 Web: [www.xmhl.com](http://www.xmhl.com)

地址：厦门市翔安区舩阳南路 189 号

Add: No.189,Fangyang South Road,Xiang'an District,Xiamen China

## 1 概述 General

光耦产品 HPL6M237 由 850nm 砷化铝镓红外发光二极管同超高速逻辑门光敏芯片耦合封装构成。产品输出端为集电极开路输出，从而允许线或输出。正常工作温度可达  $-40^{\circ}\text{C} \sim +110^{\circ}\text{C}$ 。输入端提供最大 5mA 的电流，输出端即可吸收最小 13mA 的电流。产品具有很强的共模抑制能力。



图 1 产品 Figure 1-Product

The HPL6M237 optocouplers consist of a 850 nm AlGaAS LED, optically coupled to a very high speed integrated photo-detector logic gate with a strobable output. This output features an open collector, thereby permitting wired or outputs. The coupled parameters are guaranteed over the temperature range of  $-40^{\circ}\text{C}$  to  $+110^{\circ}\text{C}$ . A maximum input of 5mA will provide a minimum output sink current of 13mA. Products have strong common mode rejection capability.

## 2 特点 Features

- 数据传输速率快。High speed:15 Mbit/s.
- 逻辑门输出。Logic gate output.
- 输入、输出间绝缘电压高。The isolation voltage between input and output is high: VISO $\geq$ 3750Vrms.
- 双列贴片式 8L 塑料封装。8L SOP plastic package.
- TTL/LSTTL 双路兼容。TTL/LSTTL Compatible:3.3V/5V dual supply.
- 符合 RoHS 指令最新要求及 REACH 法规最新要求。Compliance with the latest requirements of the RoHS Directive and the latest REACH requirements.
- 产品符合 UL/cUL、VDE 安规认证。The products comply with UL,VDE safety certification.  
UL/cUL 证书编号: E178703; VDE 证书编号: 40004708  
UL/cUL Certificate No. E178703; VED Certificate No. 40004708

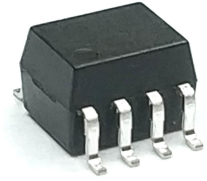
## 3 应用 Applications

- 线接收器。Line receivers.
- 数据传输。Data transmission.
- 计算机外围接口。Computer-peripheral interface.
- 替代脉冲变压器。Pulse transformer replacement.
- 开关电源。Switching power supply.

## 4 真值表及电原理图 Truth Table and Schematic



图 2 电原理图  
Figure 2-Schematic

表 1 真值表  
Table 1-Truth Table

LED	OUTPUT
ON	L
OFF	H

## 5 绝缘特性 IEC/EN/DIN EN 60747-5-5 Insulation Characteristics\*

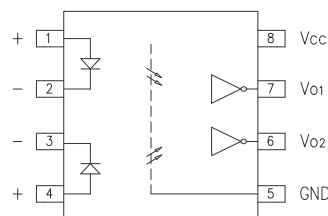
表 2 绝缘特性

Table 2-Insulation Characteristics

Description	Symbol	Value	Unit
Installation classification per DIN VDE 0110, Table 1			
for rated mains voltage $\leq 150$ Vrms		I – IV	
for rated mains voltage $\leq 300$ Vrms		I – IV	
for rated mains voltage $\leq 600$ Vrms		I – IV	
Climatic Classification		40/85/21	
Pollution Degree (DIN VDE 0110/39)		2	
Maximum Working Insulation Voltage	$V_{IORM}$	565	Vpeak
Input to Output Test Voltage, Method b* $V_{IORM} \times 1.875 = V_{PR}$ , 100% Production Test with $t_m=1$ sec, Partial discharge $< 5$ pC	$V_{PR}$	1060	Vpeak
Input to Output Test Voltage, Method a* $V_{IORM} \times 1.6 = V_{PR}$ , Type and Sample Test, $t_m=10$ sec, Partial discharge $< 5$ pC	$V_{PR}$	904	Vpeak
Highest Allowable Overvoltage (Transient Overvoltage time = 60 sec)	$V_{IOTM}$	4000	Vpeak
Case Temperature	$T_s$	150	°C
Input Current	$I_s$ , INPUT	50	mA
Output Power	$P_s$ , OUTPUT	250	mW
Insulation Resistance at $T_s$ , $V_{IO} = 500$ V	$R_s$	$\geq 10^9$	$\Omega$
Tracking Resistance (Comparative Tracking Index)	CTI	$>175$	V

\*请参阅当前目录中 IEC/EN/DIN EN 60747-5-5 《产品安全条例》章节的光耦合器部分前面的详细描述。

\*Refer to the front of the optocoupler section of the current catalog, under Product Safety Regulations section IEC/EN/DIN EN 60747-5-5, for a detailed description.

注:隔离特性只保证在安全最大额定值内,应用中的保护电路必须保证安全最大额定值。

Note: Isolation characteristics are guaranteed only within the safety maximum ratings which must be ensured by protective circuits in application.

## 6 极限参数 Absolute Maximum Ratings

表 3 极限参数

Table 3-Absolute Maximum Ratings

( $T_a=25^\circ\text{C}$ ,  $\text{RH}=30\sim 75\%$ )

参数名称 Characteristic	符号 Symbol	额定值 Rating	单位 Unit
正向电流 Forward Current	$I_F$	20	mA
正向脉冲电流 Pulse Forward Current ( $t=1\text{ms}$ , 50% duty cycle)	$I_{FP}$	40	mA
反向电压 Reverse Voltage	$V_R$	5	V
输入功耗降额 Input power dissipation derating ( $T_a \geq 25^\circ\text{C}$ )	$\Delta P_I/\Delta^\circ\text{C}$	-2.0	mW/°C
输入端功耗 Input Power Dissipation	$P_I$	40*	mW

	节温 Junction Temperature	$T_J$	105	°C
输出端 output	输出电流 Output Current	$I_o$	50*	mA
	电源电压 Supply Voltage (1min Max)	$V_{CC}$	7	V
	输出电压 Output Voltage	$V_o$	7	V
	输出功率降额 Output power dissipation derating ( $T_a \geq 25^\circ\text{C}$ )	$\Delta P_o/\Delta^\circ\text{C}$	-0.3	mW/°C
	输出端功耗 Output Power Dissipation	$P_o$	60*	mW
	节温 Junction Temperature	$T_J$	105	°C
工作温度 Operating temp.		$T_{aop}$	-40 ~ +110	°C
贮存温度 Storage temp.		$T_{stg}$	-55 ~ +125	°C
焊接温度 Soldering Temperature	手工焊 Hand Soldering (3 Sec.)	$T_{slid}$	360	°C
	回流焊 Reflow Soldering (5 Sec.)		260	
绝缘电压 Isolation voltage (RH≤60%,交流 1 分钟) (RH≤60%, AC 1min.)		$V_{ISO}$	3750	$V_{rms}$

\*单个通道。

\*Each channel.

## 7 推荐工作条件 Recommended Operating Conditions

表 4 推荐工作条件

Table 4-Recommended Operating Conditions

参数名称 Characteristic	符号 Symbol	最小值 Min.	最大值 Max.	单位 Unit.
低电平输入电流 Input Current,Low Level	$I_{FL}$	0	250	μA
低电平输入电压 Input Current,Low Level	$V_{FL}$	0	0.8	V
高电平输入电流 Input Current,High Level	$I_{FH}$	7	20	mA
输出端电源电压 Power Supply Voltage	$V_{CC}$	4.5	5.5	V
	$V_{CC}$	2.7	3.6	V
扇出数 Fan Out (TTL Loads) $R_L = 1k\ \Omega$	N		5	TTL Loads
输出端上拉电阻 Output Pull-up Resistor	RL	330	4K	Ω

## 8 光电参数 Opto-Electrical Characteristics

表 5 光电参数

Table 5-Opto-Electrical Characteristics

(Ta=25°C, RH=30~75%)

参数 Parameters		符号 Symb.	测试条件 Test Conditions	最小 值 Min.	特征 值 Typ.	最大 值 Max.	单 位 Unit
输入端 Input	正向电压 Forward Voltage	$V_F$	$I_F=10\text{mA}$		1.35	1.7	V
	输入端反向击穿电压 Input Reverse Breakdown Voltage	$BV_R$	$I_R=10\mu\text{A}$	5			V
	反向电流 Reverse Current	$I_R$	$V_R=6\text{V}$			5	$\mu\text{A}$
	输入端电容 Input Capacitance	$C_{IN}$	$f=1\text{MHz}$		60		pF
输出端 Output	高电平电源电流 High Level Supply Current	$I_{CCH}$	$V_{CC}=5.5\text{V}$ $I_F=0\text{mA}$			15	mA
	低电平电源电流 Low Level Supply Current	$I_{CCL}$	$V_{CC}=5.5\text{V}$ $I_F=10\text{mA}$			21	mA
耦合 Coupler	高电平输出电流 High Level Output Current	$I_{OH}$	$I_F=0.25\text{mA}$ $V_{CC}=5.5\text{V}$ $V_O=5.5\text{V}$		5.5	100	$\mu\text{A}$
	低电平输出电压 Low Level Output Voltage	$V_{OL}$	$I_F=5\text{mA}$ $V_{CC}=5.5\text{V}$ $I_{OL}=13\text{mA}$		0.35	0.6	V
	触发电流 Input Threshold Current	$I_{TH}$	$I_{OL}=13\text{mA}$ $V_{CC}=5.5\text{V}$ $V_O=0.6\text{V}$		2	5	mA
开关 Switching	输出端逻辑由低到高的传输延迟 时间 Propagation Delay Time to Logic Low at Output	$t_{PHL}$	$R_L=350\Omega$ $C_L=15\text{pF}$ $I_F=7.5\text{mA}$			75	ns
	输出端逻辑由高到低的传输延迟 时间 Propagation Delay Time to Logic High at Output	$t_{PLH}$	$R_L=350\Omega$ $C_L=15\text{pF}$ $I_F=7.5\text{mA}$			75	ns
	脉宽失真 Pulse Width Distortion	$ t_{PHL}-t_{PLH} $	$R_L=350\Omega$ $C_L=15\text{pF}$ $I_F=7.5\text{mA}$		10	35	ns
	输出端为高电平时的共模抑制能 力 Common Mode Transient Immunity at Logic High Level Output	$ CM_H $	$R_L=350\Omega$ $I_F=0\text{mA}$ $V_{O(\min)}=2.0\text{V}$ $ V_{CM} =10\text{V}_{P-P}$	15000			V/ $\mu\text{s}$
	输出端为低电平时的共模抑制能 力 Common Mode Transient Immunity at Logic High Level Output	$ CM_L $	$R_L=350\Omega$ $I_F=7.5\text{mA}$ $V_{O(\max)}=0.8\text{V}$ $ V_{CM} =10\text{V}_{P-P}$	15000			V/ $\mu\text{s}$
	输出端上升时间 Output Rise Time(10%~90%)	$t_r$	$R_L=350\Omega$ $C_L=15\text{pF}$		24	35	ns
	输出端下降时间 Output Fall Time(90%~10%)	$t_f$	$I_F=7.5\text{mA}$		10	25	
隔离 Isolation	绝缘电压 Isolation voltage	$V_{ISO}$	$I_{off}\leq 0.3\text{mA}$ , AC, 60s	3750			V
	常温绝缘电阻 Isolation Resistance between Input and Input	$R_{I-I}$	$V_{I-I}=500\text{V DC}$	$10^{11}$			$\Omega$

	常温绝缘电阻 Isolation Resistance between Input and Output	$R_{I-O}$	$V_{I-O}=500V$ DC	$10^{12}$		$\Omega$
	输入-输出电容 Capacitance (Input to Output)	$C_{I-O}^a$	$f = 1MHz$		0.6	pF

<sup>a</sup>  $C_{I-O}$ 测试是将PIN1,2,3,4短接在一起, PIN5,6,7,8短接在一起。Device considered a two-terminal device: Pins 1, 2, 3 and 4 shorted together, and Pins 5, 6, 7 and 8 shorted together.

## 9 特性曲线图 Characteristic Curve



图 3  $V_F$ - $I_F$  特性曲线

Figure 3-Typical input diode forward characteristic

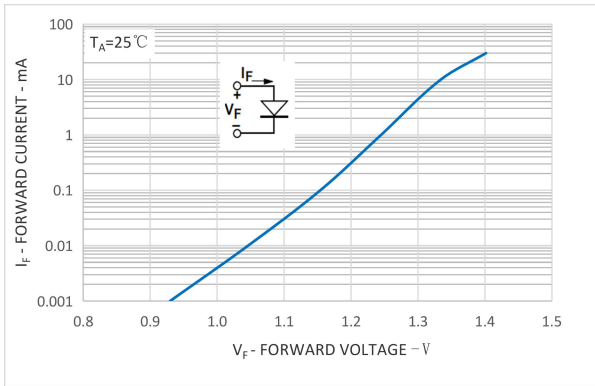

图 4  $I_{F(max.)}$ - $T_A$  特性曲线

Figure 4- $I_{F(max.)}$  vs. Temperature

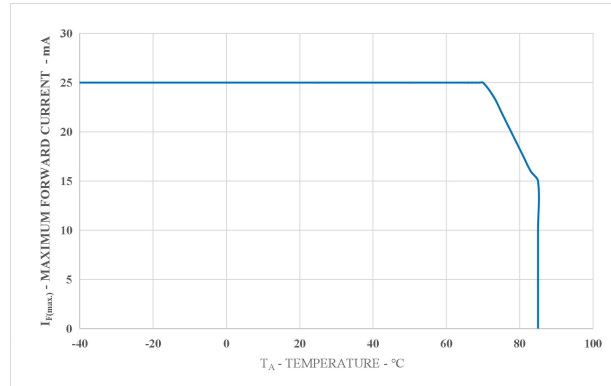

图 5  $I_{TH}$ - $T_A$  特性曲线 ( $V_{CC}=3.3V$ )

Figure 5-Input threshold current vs. Temperature

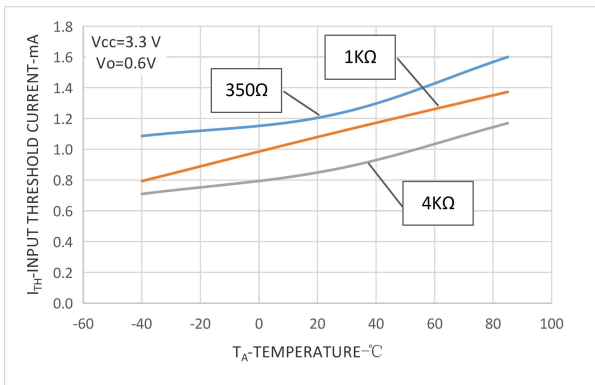

图 6  $I_{TH}$ - $T_A$  特性曲线 ( $V_{CC}=5V$ )

Figure 6-Input threshold current vs. Temperature



图 7  $I_{OH}$ - $T_A$  特性曲线 ( $V_{CC}=3.3V$ )  
Figure 7-Typical high level output current vs. Temperature

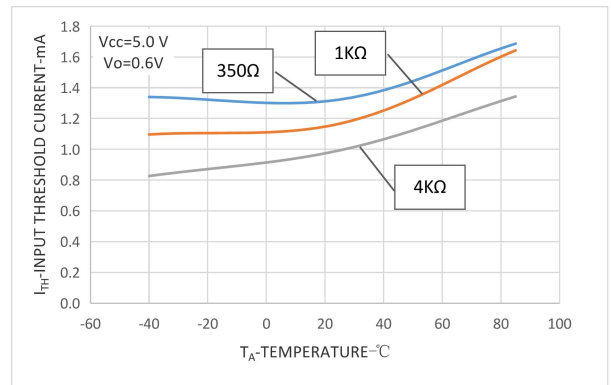

图 8  $I_{OH}$ - $T_A$  特性曲线 ( $V_{CC}=5V$ )  
Figure 8-Typical high level output current vs. vs. temperature

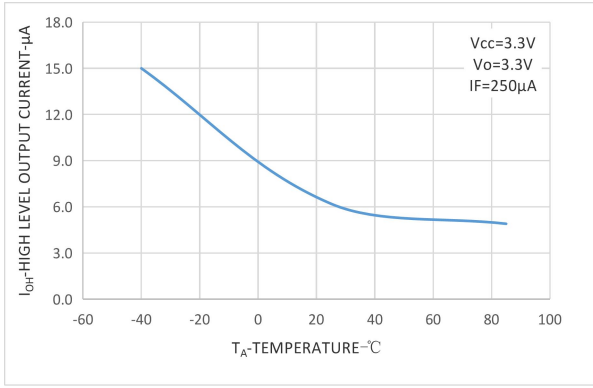

图 9  $V_{OL}$ - $T_A$  特性曲线 ( $V_{CC}=3.3V$ )  
Figure 9-Typical low level output voltage vs. Temperature

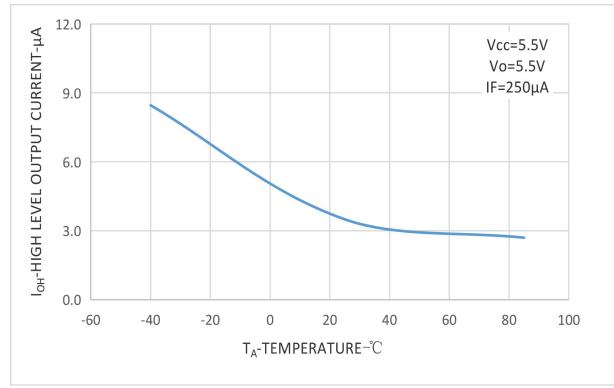

图 10  $V_{OL}$ - $T_A$  特性曲线 ( $V_{CC}=5.5V$ )  
Figure 10-Typical low level output voltage vs. temperature

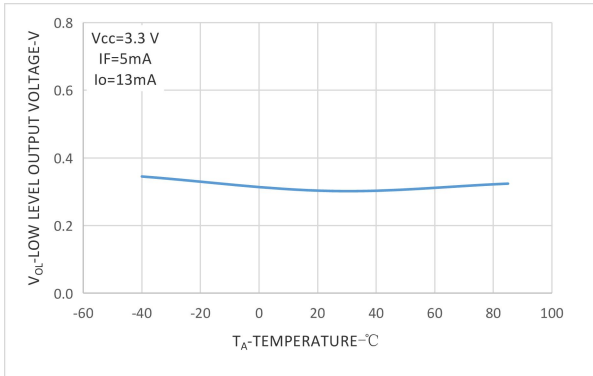

图 11  $I_{OL}$ - $T_A$  特性曲线 ( $V_{CC}=3.3V$ )  
Figure 11-Typical low level output current vs. Temperature

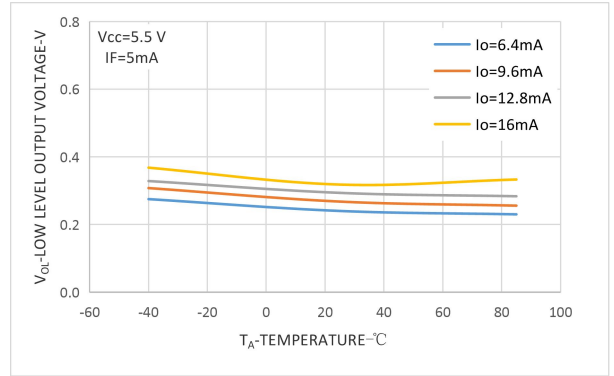

图 12  $I_{OL}$ - $T_A$  特性曲线 ( $V_{CC}=5V$ )  
Figure 12-Typical low level output current vs. vs. Temperature

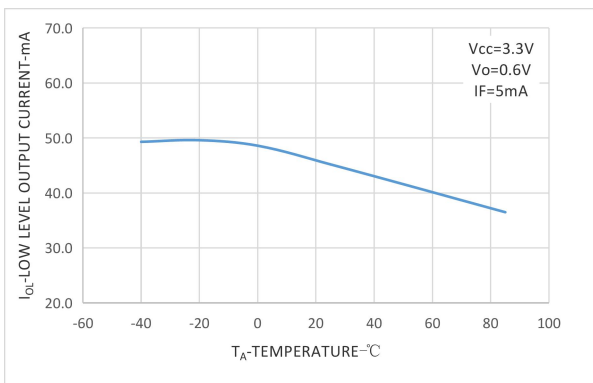

图 13  $t_p$ - $T_A$  特性曲线 ( $V_{cc}=3.3V$ )  
Figure 13-Typical propagation delay vs. temperature.

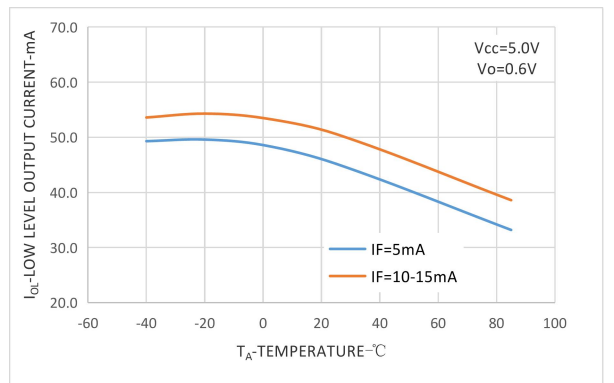

图 14  $t_p$ - $T_A$  特性曲线 ( $V_{cc}=5V$ )  
Figure 14-Typical propagation delay vs. temperature.

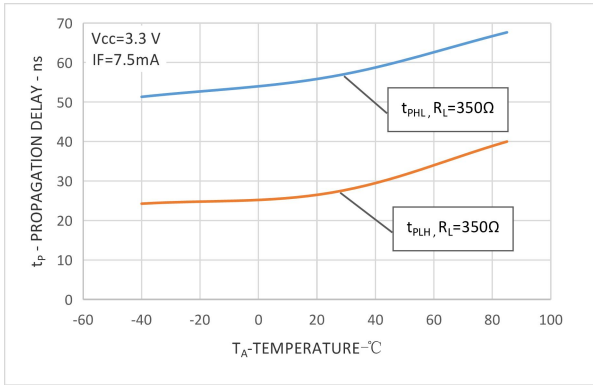

图 15  $t_{PHL}$ 、 $t_{PLH}$  测试方法  
Figure 15- The test method of  $t_{PHL}$ 、 $t_{PLH}$



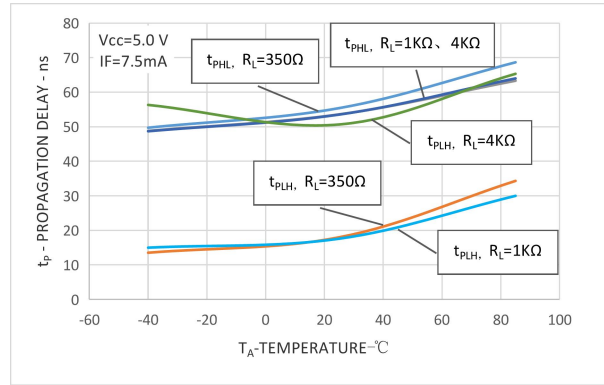

图 16 应用电路推荐

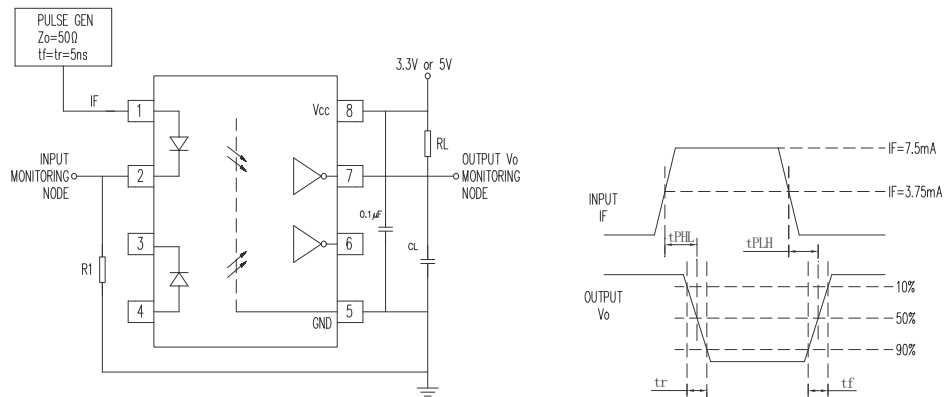
Figure 16- Recommended printed circuit board layout

## 10 外形尺寸 Dimensions

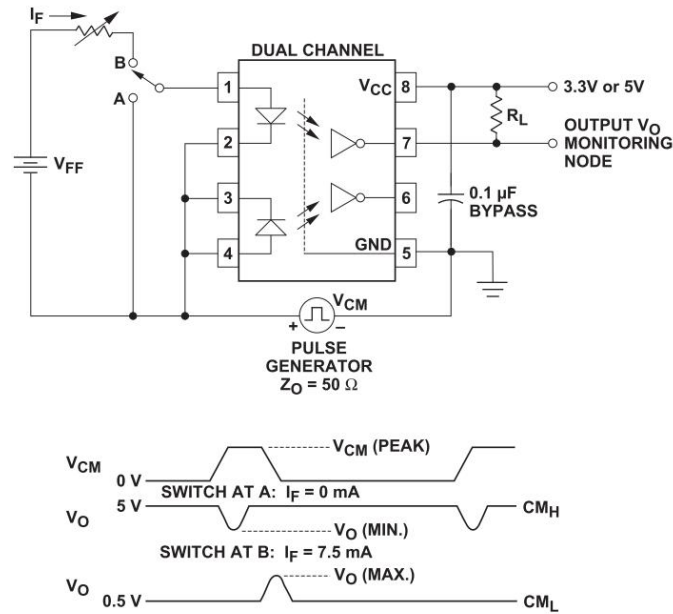

图 17 HPL6M237 外形尺寸

Figure 17- The dimensions of HPL6M237

## 11 标志 Mark

产品上应有型号、公司商标、生产日期代码、引出端识别标记。例如：**HPL6M237** 产品印章如图 18。

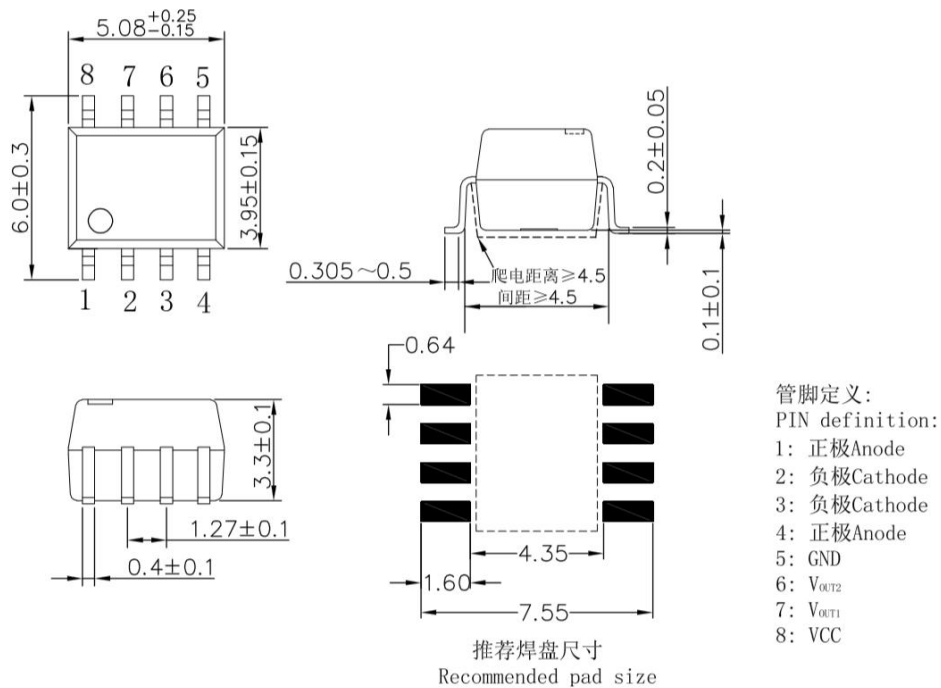
Print type characters ,trade mark and Lot.No.on the Photo Coupler.For example the marking of product **HPL6M237** is shown as Figure 18.

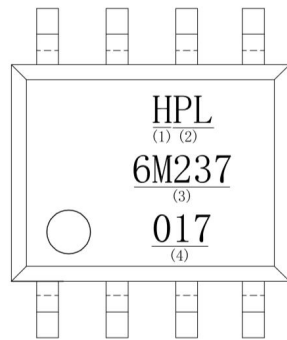

- (1) 公司简称 Company Mark
- (2) 高速逻辑门输出型光耦合器简称 High-Speed Logic Gate Opto-coupler abbreviation
- (3) 型号 Model
- (4) 生产年周代码 Production year and week code

图 18 产品印章  
Figure 18- Marking

## 12 包装方式 Packing

### 12.1 编带包装 (Tape and reel) : 适用于 For HPL6M237

12.1.1 每卷数量 (Qty/reel) : 2000 只 (pcs)。每箱数量 (Qty/ctn) : 40000 只 (pcs)。

#### 12.1.2 内包装 (Inner packing) :

每卷盘 2000 只, 贴合格证 (型号、生产日期代号、检验员代号)。

2000pcs/reel, certificate on reel (model, code of product date, Inspector's code)

#### 12.1.3 外包装(Outer packing):

公司名称、地址、商标、产品型号、数量等标志。

Indication of company name, address, trade mark, model and quantity.

#### 12.1.4 示意图 (Schematic) :



图 19 编带包装示意图  
Figure 19- Taping Packing Schematic

### 13 使用注意事项 Note

13.1 推荐贮存温度 Recommend storage Temp.: 0~40°C;

推荐贮存湿度 Recommend storage humidity: <60%;

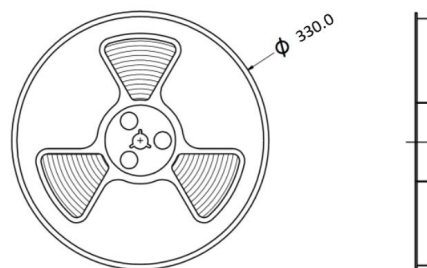
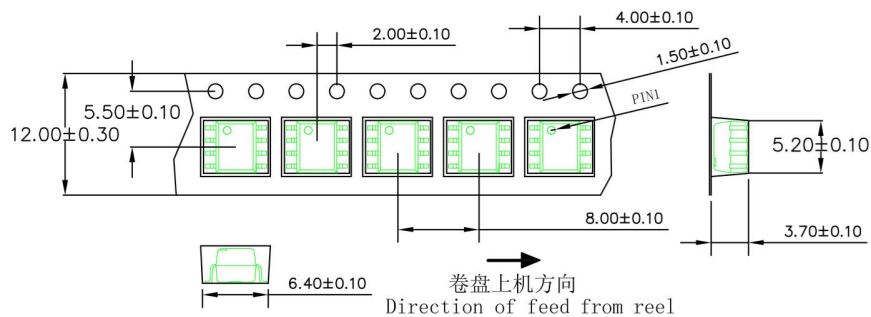
湿气敏感度等级 1 级。MSL level: MSL 1.

13.2 引脚镀锡厚度: 大于等于 3μm。

Thickness of Sn which plated on lead frame: ≥3μm.

13.3 推荐焊接条件 Recommended Soldering Conditions

13.3.1 请勿使用超过最高贮存温度的物体直接接触环氧本体。

Do not contact the epoxy body directly with objects exceeding the maximum storage temperature.

13.3.2 在高温下不要对环氧本体施加压力, 特殊情况下施加的力不应超过2.5N。

Do not apply pressure to the epoxy at high temperatures, and in special cases do not apply more than 2.5N.

13.3.3 回流焊 Reflow soldering

1) 推荐锡膏规格 Recommend tin glue specifications:

a) 熔点 Melting temperature: 217°C

b) 组分 Contains: SnAg3Cu0.5

2) 回流焊工序必须在器件冷却至室温后进行。Never take next process until the component is cooled down to room temperature after reflow.

3) 推荐回流焊接参数, 如下图所示: The recommended reflow soldering profile is following:

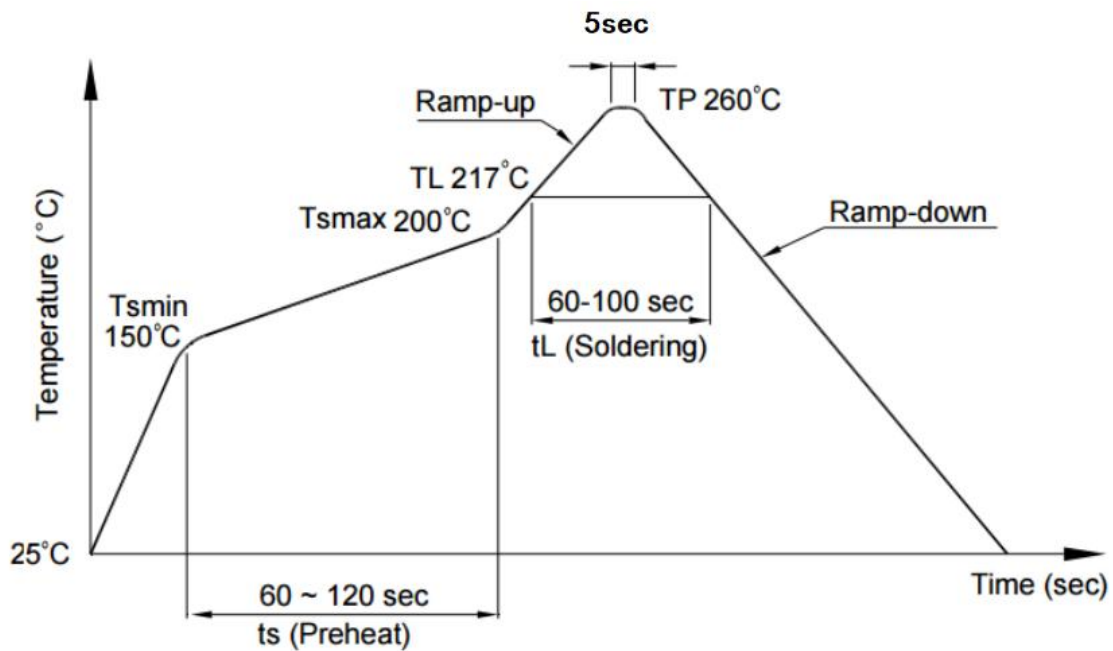

项目 Items		条件 Conditions
预热 Preheat	Temperature Min ( $T_{Smin}$ )	150°C
	Temperature Max ( $T_{Smax}$ )	200°C
	Time (min to max) ( $t_s$ )	90±30 sec
焊接区 Soldering zone	Temperature ( $T_L$ )	217°C
	Time ( $t_L$ )	60 ~100 sec
最高温度 Peak Temperature ( $T_P$ )		260°C
升温速率 Ramp-up rate		3°C / sec max.
降温速率 Ramp-down rate		3~6°C / sec

图 20 回流焊参数

Figure 20-Recommended reflow soldering profile

4) 建议在所示的温度和时间条件下进行一次回流焊, 最多不能超过三次。One time soldering reflow

is recommended within the condition of temperature and time profile shown below. Do not solder more than three times.

#### 13.3.4 手工烙铁焊 Manual soldering

1) 手工烙铁焊仅用于产品返修或样品测试。Manual soldering is only applicable to product repair.

2) 手工烙铁焊要求：温度 $360^{\circ}\text{C} \pm 5^{\circ}\text{C}$ ，时间 $\leq 3\text{s}$ ，返修次数 $\leq 2$ 次。Manual soldering requirements: temperature  $\leq (360^{\circ}\text{C} \pm 5^{\circ}\text{C})$ , time  $\leq 3\text{s}$ , repair times  $\leq 2$  times.

**13.4** 本说明书所展示的产品是为一般电子应用而设计的，如办公自动化设备、通讯设备、视听设备、电气应用和仪器仪表等。对于需要高可靠性或安全性的设备，如空间应用、核动力控制设备、医疗设备等，请与我们的销售代表联系。The products shown in this publication are designed for the general use in electronic applications such as office automation equipment, communications devices, audio/visual equipment, electrical application and instrumentation. For equipment/devices where high reliability or safety is required, such as space applications, nuclear power control equipment, medical equipment, etc, please contact our sales representatives.

## 14 产地 Production Place

**14.1** 产地 Production Place: 中国厦门 Xiamen China;

**14.2** 工厂名称 Production NO.: 厦门华联半导体科技有限公司; Xiamen Hualian Semiconductor Technology Co., Ltd.;

**14.3** 工厂地址 Production Add.: 厦门市翔安区舫阳南路 189 号 No.189, Fangyang South Road, Xiang'an District, Xiamen China.

更改记录表  
Engineering Change Notice-Record

版次 Edition	更改日期 Date	主要更改内容 Main Content	拟制 Prepared	确认 Checked
1.0	2020-03-13	新版发行 New edition	黄发宝	段果
1.1	2020-03-24	规格书内的型号由 HPL6N137-MS8 改为 HPL6N137D-MS8	黄发宝	段果
1.2	2020-04-14	表 4 推荐工作条件增加 Vcc: 2.7V~3.6V	黄发宝	段果
1.3	2020-04-24	1、产品型号由 HPL6N137-MS8 改为 HPL6M237; 2、第 7 页产品丝印做相应调整; 3、10.3.2 湿度敏感度等级由 MSL3 改为 MSL1。	黄发宝	段果
1.4	2020-05-18	1、图 9 产品外形图增加管脚定义描述。 2、图 11 增加卷盘图示。 3、推荐回流焊曲线参数调整。	黄发宝	段果
1.5	2020-06-19	1、数据传输速率由 10Mbps 变更为 15Mbps; 2、新增表 2 安规绝缘特性; 3、表 5 中增加 4 个项目: 1) 输入端电容 C <sub>IN</sub> ; 2) 常温绝缘电阻 R <sub>I-I</sub> ; 3) 常温绝缘电阻 R <sub>I-O</sub> ; 4) 脉宽失真 t <sub>PHL</sub> -t <sub>PLH</sub>  ; 4、第 10.3.1 项增加工作湿度范围; 5、新增第 10.3.3 项静电等级;	黄发宝	段果
1.6	2020-08-05	表 5 光电参数表“共模抑制能力”下限值由 10k 改为 15k。	黄发宝	段果
1.7	2020-09-17	图 9 外形图焊端尺寸由 min.0.305 改为 0.305~0.5。	黄发宝	段果
1.8	2020-12-30	1、补充完善极限参数表和光电参数表。 2、补充完善特性曲线。 3、外形图增加爬电距离和电气间隙，端子尺寸公差，增加推荐的焊盘尺寸; 4、增加印章说明; 5、增加编带示意图拉出方向; 6、修订标签图示; 7、更新推荐的回流焊曲线，增加返修手工焊接要求; 8、修订部分使用注意事项。	黄发宝	段果
1.9	2022-04-21	1. 新增输入端与输出端的降额功耗参数。 2. 表 2 新增绝缘电阻。	黄发宝	段果
1.10	2022-12-27	1. 更改工厂地址、删除邮编; 2. 工作温度上限由 85℃调整至 110℃; 3. 删除 12.2 标识 Label; 4. 更新图 20 回流焊参数。	张强龙	黄发宝
1.11	2023-11-02	1、公司名称变更为华联半导体科技有限公司; 2、新增安规认证说明以及证书编号。	姚彭彭	黄发宝