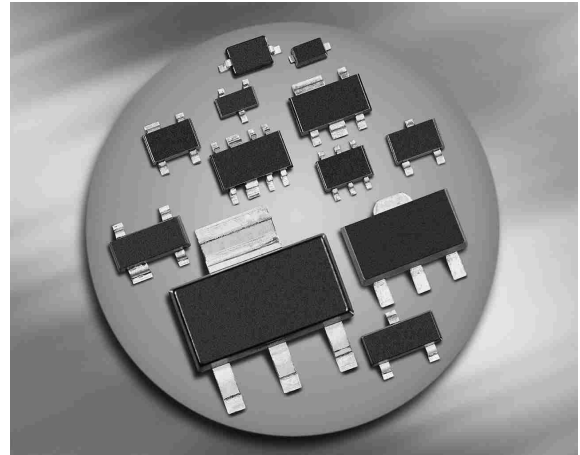
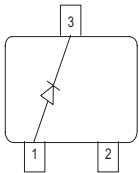
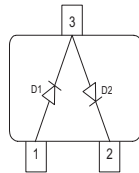
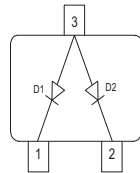
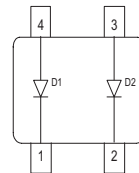
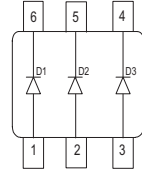

Silicon Schottky Diodes

- For mixer applications in the VHF / UHF range
- For high-speed switching applications
- Pb-free (RoHS compliant) package

BAT68

**BAT68-04
BAT68-04W**

**BAT68-06
BAT68-06W**

BAT68-07W

BAT68-08S

ESD (Electrostatic discharge) sensitive device, observe handling precaution!

Type	Package	Configuration	L_S (nH)	Marking
BAT68	SOT23	single	1.8	83s
BAT68-04	SOT23	series	1.8	84s
BAT68-04W	SOT323	series	1.4	84s
BAT68-06	SOT23	common anode	1.8	86s
BAT68-06W	SOT323	common anode	1.4	86s
BAT68-07W	SOT343	parallel pair	1.6	87s
BAT68-08S	SOT363	parallel triple	1.4	83s

Maximum Ratings at $T_A = 25^\circ\text{C}$, unless otherwise specified

Parameter	Symbol	Value	Unit
Diode reverse voltage	V_R	8	V
Forward current	I_F	130	mA
Total power dissipation BAT68, $T_S \leq 77^\circ\text{C}$ BAT68-04, BAT68-06, $T_S \leq 61^\circ\text{C}$ BAT68-04W/-06W/-08S, $T_S \leq 92^\circ\text{C}$ BAT68-07W, $T_S \leq 89^\circ\text{C}$	P_{tot}	150 150 150 150	mW
Junction temperature	T_j	150	°C
Storage temperature	T_{stg}	-55 ... 150	

Thermal Resistance

Parameter	Symbol	Value	Unit
Junction - soldering point ¹⁾ BAT68 BAT68-04, BAT68-06 BAT68-04W-BAT68-06W, BAT68-08S BAT68-07W	R_{thJS}	≤ 490 ≤ 590 ≤ 390 ≤ 410	K/W

Electrical Characteristics at $T_A = 25^\circ\text{C}$, unless otherwise specified

Parameter	Symbol	Values			Unit
		min.	typ.	max.	
Breakdown voltage $I_{(\text{BR})} = 10 \mu\text{A}$	$V_{(\text{BR})}$	8	-	-	V
Reverse current $V_R = 1 \text{ V}$ $V_R = 1 \text{ V}, T_A = 60^\circ\text{C}$	I_R	- -	- -	0.1 1.2	μA
Forward voltage $I_F = 1 \text{ mA}$ $I_F = 10 \text{ mA}$	V_F	- 340	318 390	340 500	mV

¹⁾For calculation of R_{thJA} please refer to Application Note Thermal Resistance

Electrical Characteristics at $T_A = 25^\circ\text{C}$, unless otherwise specified

Parameter	Symbol	Values			Unit
		min.	typ.	max.	
AC Characteristics					
Diode capacitance $V_R = 0, f = 1 \text{ MHz}$	C_T	-	-	1	pF
Differential forward resistance $I_F = 5 \text{ mA}, f = 10 \text{ kHz}$	R_F	-	-	10	Ω

Diode capacitance $C_T = f(V_R)$

$f = 1\text{MHz}$

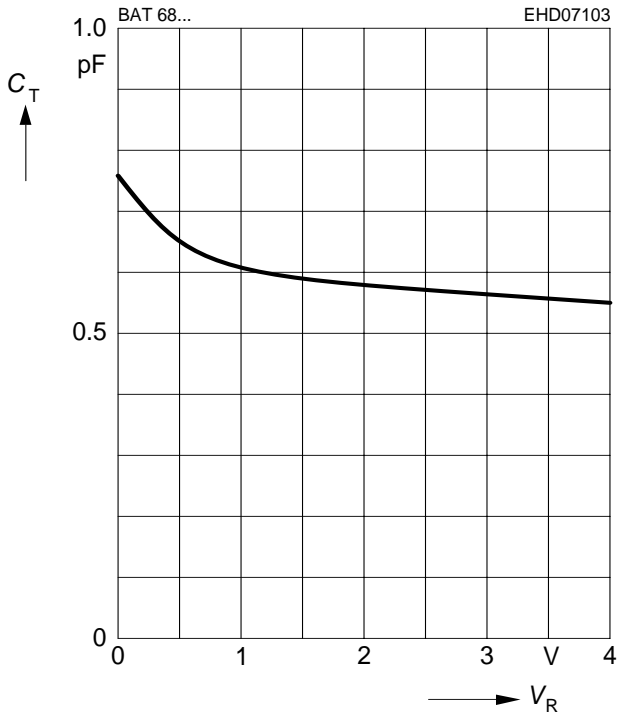

Differential forward resistance $r_f = f(I_F)$

$f = 10\text{kHz}$

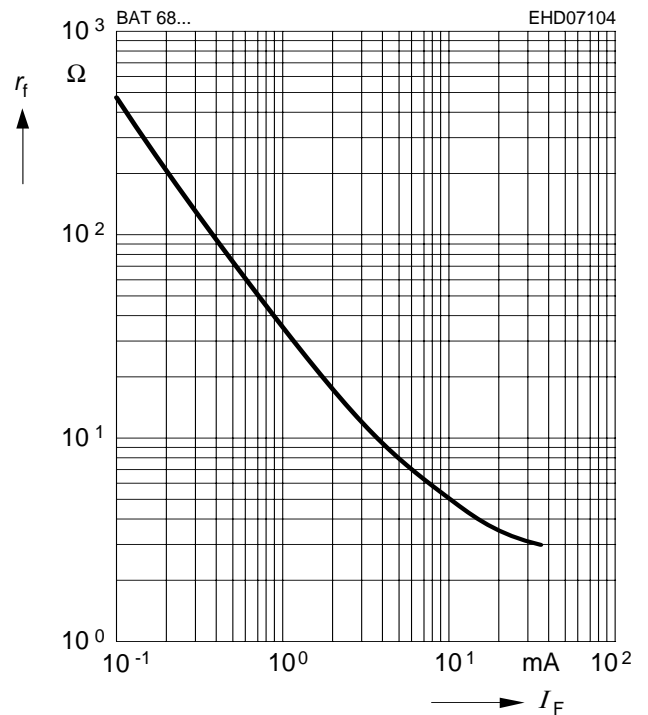

Reverse current $I_R = f(V_R)$

$T_A = \text{Parameter}$

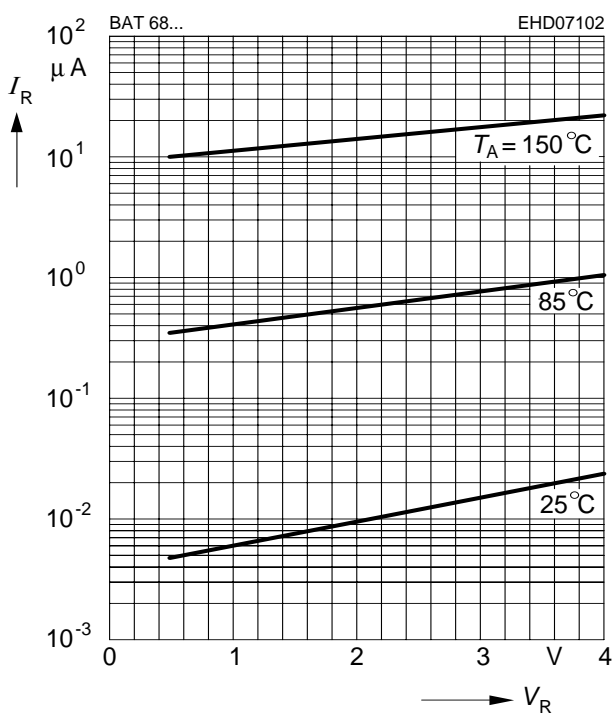

Forward current $I_F = f(V_F)$

$T_A = \text{Parameter}$

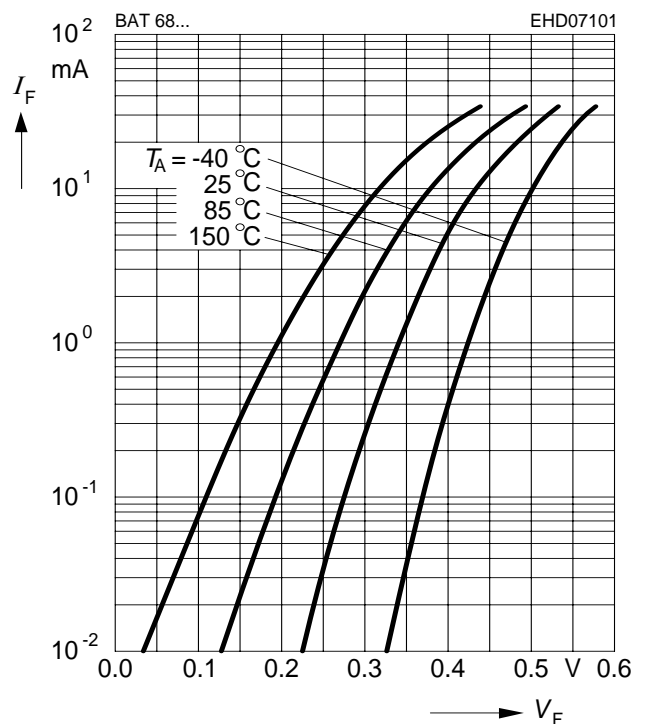

Forward current $I_F = f(T_S)$

BAT68

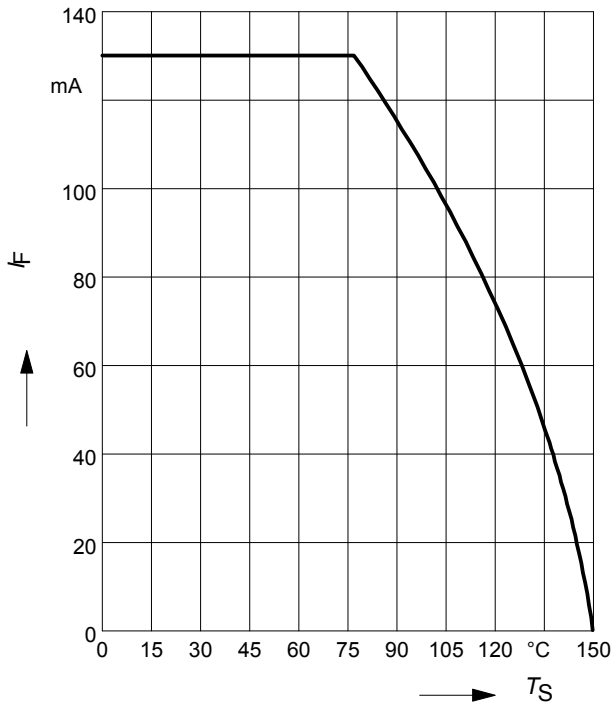

Forward current $I_F = f(T_S)$

BAT68-04, BAT68-06

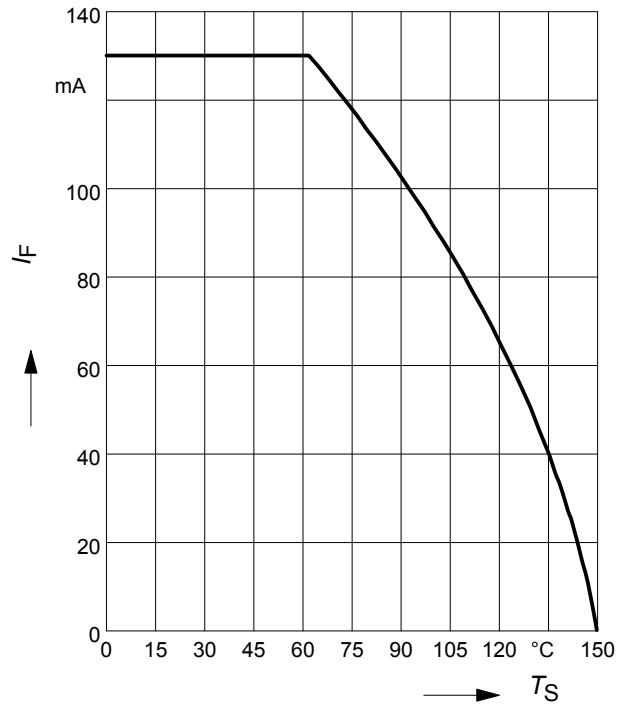

Forward current $I_F = f(T_S)$

BAT68-04W, BAT68-06W, BAT68-08S

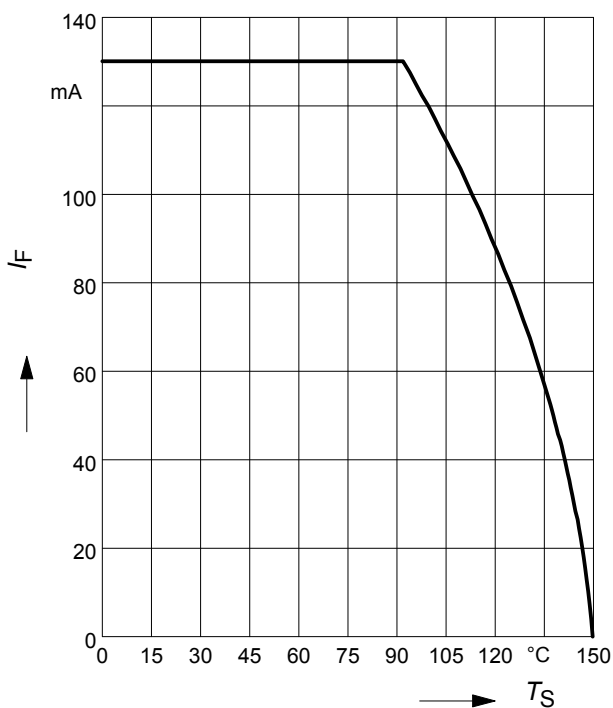

Forward current $I_F = f(T_S)$

BAT68-07W

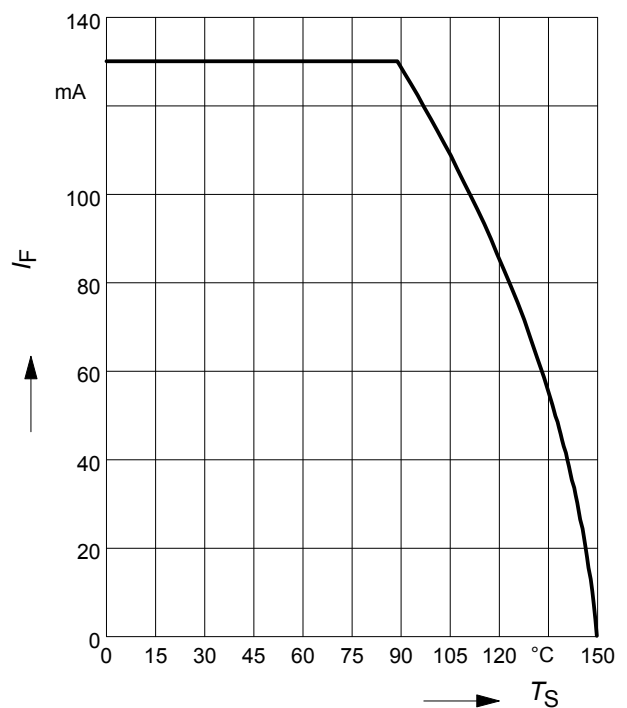

Permissible Puls Load $R_{thJS} = f(t_p)$

BAT68-04W, BAT68-06W

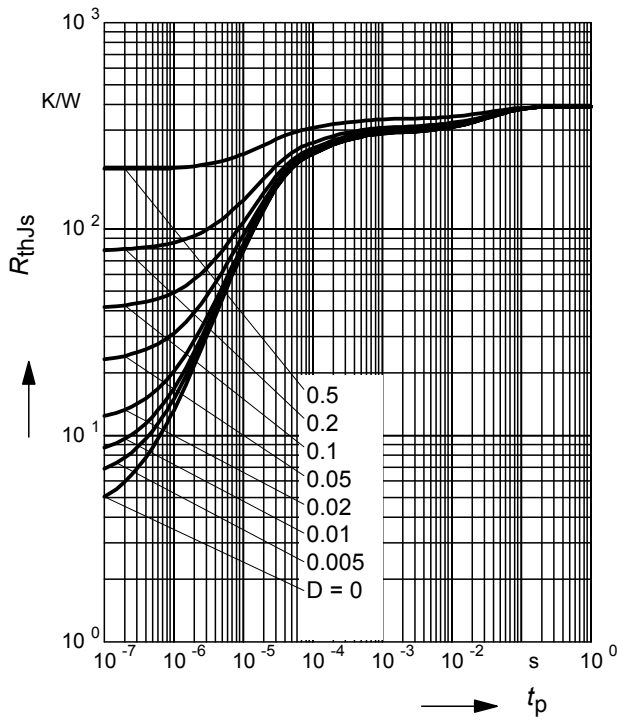

Permissible Pulse Load

$I_{Fmax} / I_{FDC} = f(t_p)$

BAT68-04W, BAT68-06W

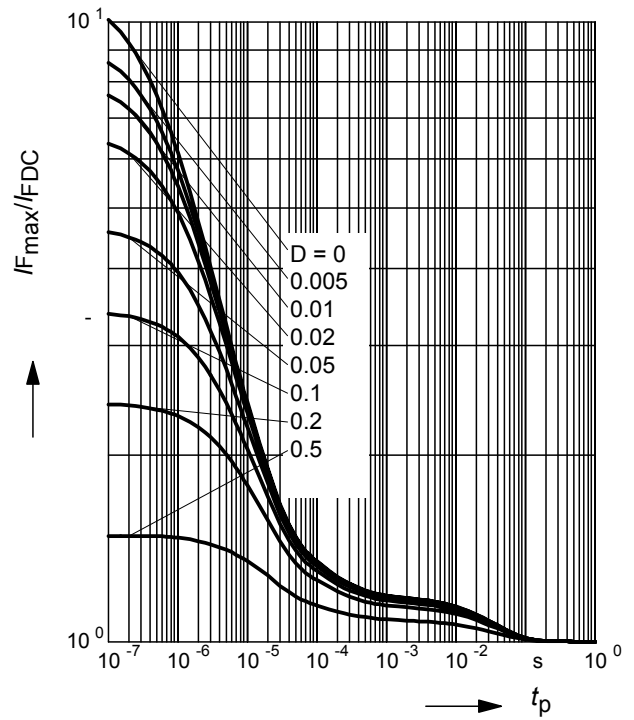

Permissible Puls Load $R_{thJS} = f(t_p)$

BAT68-07W

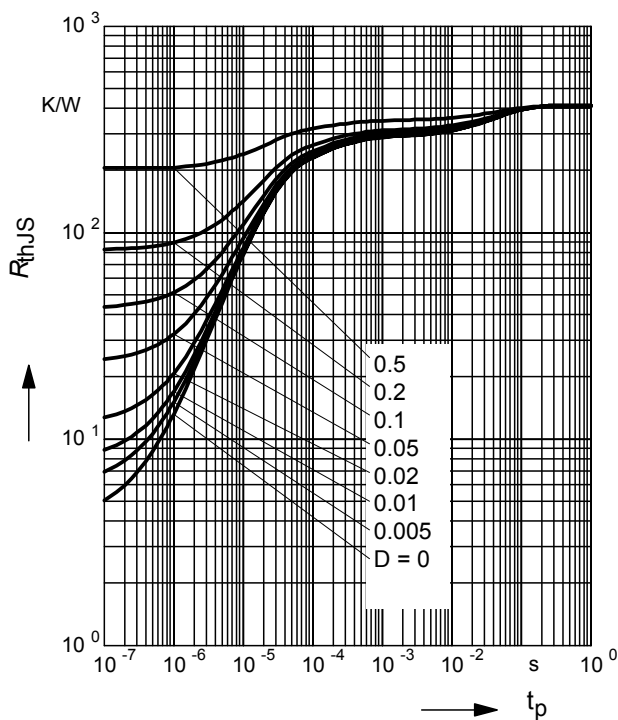

Permissible Pulse Load

$I_{Fmax} / I_{FDC} = f(t_p)$

BAT68-07W

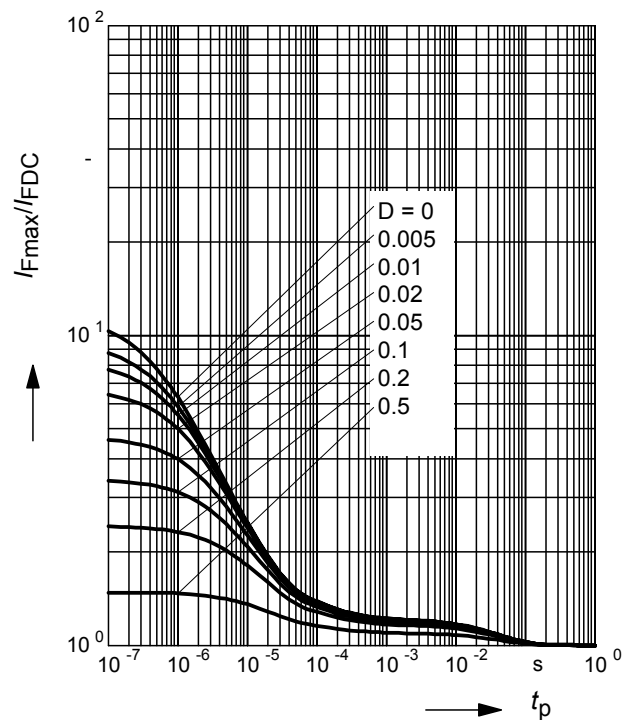

Rectifier voltage $V_{out} = f(V_{in})$

$f = 900\text{MHz}$

$R_L =$ Parameter in $k\Omega$

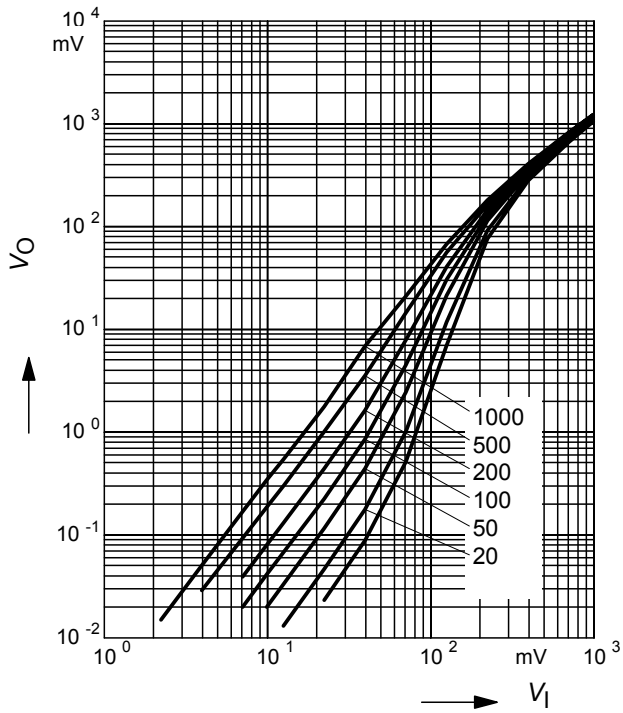

Testcircuit

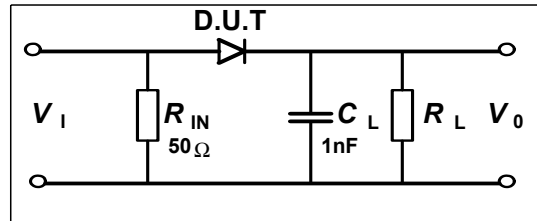

Package Outline



1) Lead width can be 0.6 max. in dambar area

Foot Print



Marking Layout (Example)



Standard Packing

Reel \varnothing 180 mm = 3.000 Pieces/Reel
 Reel \varnothing 330 mm = 10.000 Pieces/Reel

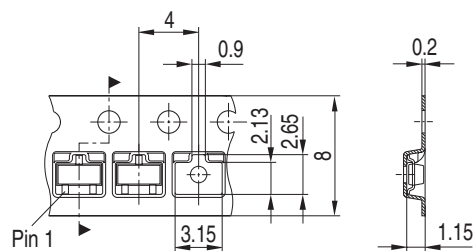

Package Outline

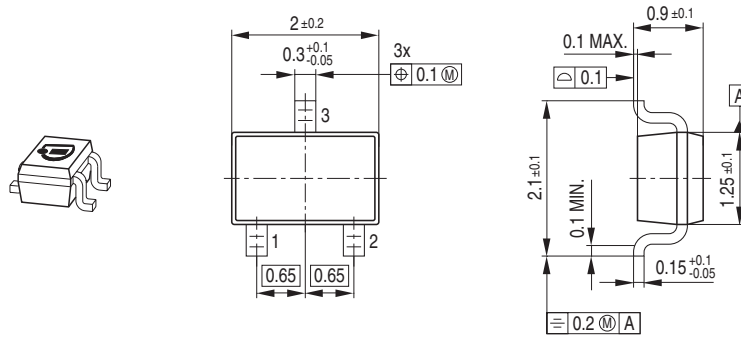

Foot Print

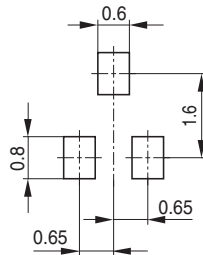

Marking Layout (Example)

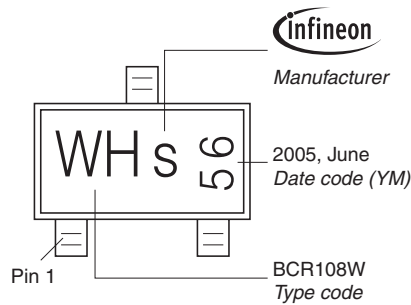

Standard Packing

Reel \varnothing 180 mm = 3.000 Pieces/Reel
 Reel \varnothing 330 mm = 10.000 Pieces/Reel

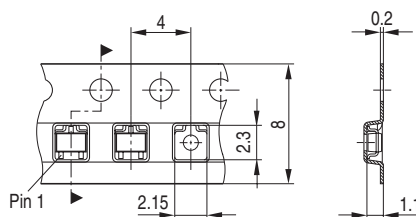

Package Outline

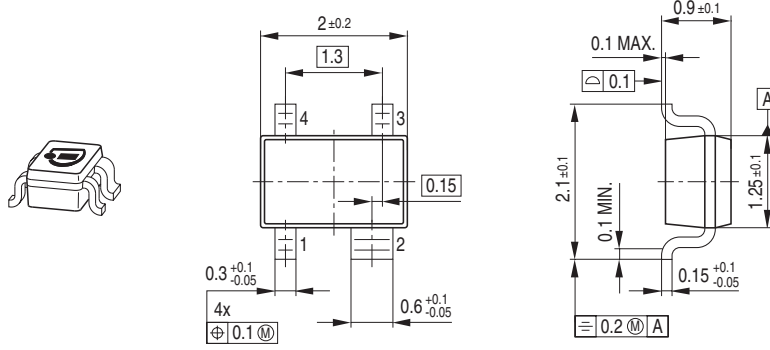

Foot Print

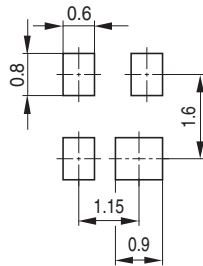

Marking Layout (Example)

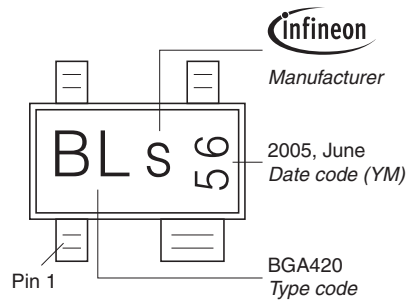

Standard Packing

Reel \varnothing 180 mm = 3.000 Pieces/Reel
 Reel \varnothing 330 mm = 10.000 Pieces/Reel

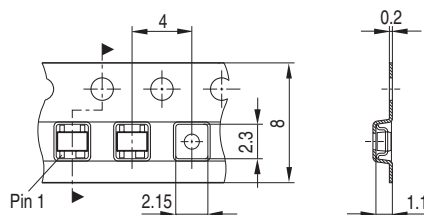

Package Outline

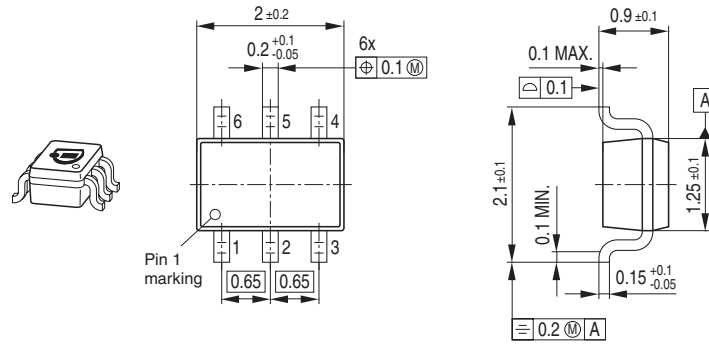

Foot Print

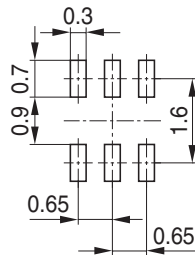

Marking Layout (Example)

Small variations in positioning of Date code, Type code and Manufacturer are possible.

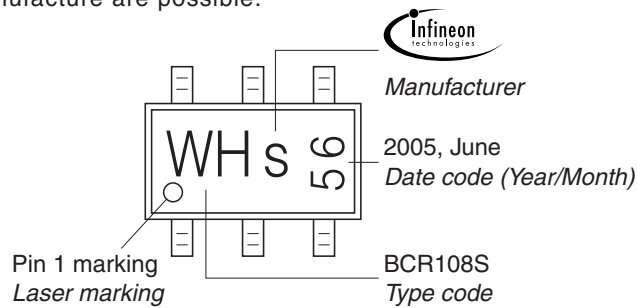

Standard Packing

Reel \varnothing 180 mm = 3.000 Pieces/Reel
 Reel \varnothing 330 mm = 10.000 Pieces/Reel

For symmetric types no defined Pin 1 orientation in reel.

