

$I_{F(AV)} = 2 \text{ Amp}$   
 $V_R = 60V$

**Major Ratings and Characteristics**

Characteristics	Values	Units
$I_{F(AV)}$ Rectangular waveform	2.0	A
$V_{RRM}$	60	V
$I_{FSM}$ @ $t_p = 5 \mu s$ sine	385	A
$V_F$ @ 1 Apk, $T_J = 125^\circ C$ (per leg)	0.56	V
$T_J$ range	-55 to 150	$^\circ C$

**Description/ Features**

The 20CJQ060 surface mount Schottky rectifier series has been designed for applications requiring very low forward drop and very small foot prints. Typical applications are in portables, switching power supplies, converters, automotive system, free-wheeling diodes, battery charging, and reverse battery protection.

- Small footprint, surface mountable
- Low profile
- Very low forward voltage drop
- High frequency operation
- Guard ring for enhanced ruggedness and long term reliability
- Common cathode

**Case Styles**



**SOT-223**

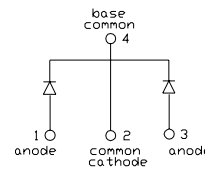

## Voltage Ratings

Part number	20CJQ060
V <sub>R</sub> Max. DC Reverse Voltage (V)	60
V <sub>RWM</sub> Max. Working Peak Reverse Voltage (V)	

## Absolute Maximum Ratings

Parameters	Values	Units	Conditions
I <sub>F(AV)</sub> Max. Average Forward (Per Leg) Current * See Fig. 5 (Per Device)	2	A	50% duty cycle @ T <sub>C</sub> = 127°C, rectangular wave form
	4		50% duty cycle @ T <sub>C</sub> = 109°C, rectangular wave form
I <sub>FSM</sub> Max. Peak One Cycle Non-Repetitive Surge Current (Per Leg) * See Fig. 7	385	A	5µs Sine or 3µs Rect. pulse 10ms Sine or 6ms Rect. pulse Following any rated load condition and with rated V <sub>RRM</sub> applied
	22		
E <sub>AS</sub> Non-Repetitive Avalanche Energy (Per Leg)	1.5	mJ	T <sub>J</sub> = 25 °C, I <sub>AS</sub> = 1 Amps, L = 3 mH
I <sub>AR</sub> Repetitive Avalanche Current (Per Leg)	1.0	A	Current decaying linearly to zero in 1 µsec Frequency limited by T <sub>J</sub> max. V <sub>A</sub> = 1.5 x V <sub>R</sub> typical

## Electrical Specifications

Parameters	Values	Units	Conditions
V <sub>FM</sub> Max. Forward Voltage Drop (Per Leg) * See Fig. 1 (1)	0.59	V	@ 1A T <sub>J</sub> = 25 °C
	0.75	V	@ 2A
	0.56	V	@ 1A T <sub>J</sub> = 125 °C
	0.67	V	@ 2A
I <sub>RM</sub> Max. Reverse Leakage Current (Per Leg) * See Fig. 2 (1)	0.1	mA	T <sub>J</sub> = 25 °C
	5.0	mA	T <sub>J</sub> = 125 °C V <sub>R</sub> = rated V <sub>R</sub>
C <sub>T</sub> Typ. Junction Capacitance (Per Leg)	60	pF	V <sub>R</sub> = 5V <sub>DC</sub> (test signal range 100Khz to 1Mhz) 25°C
L <sub>S</sub> Typical Series Inductance (Per Leg)	6	nH	Measured lead to lead 5mm from package body
dv/dt Max. Voltage Rate of Change	10000	V/µs	(Rated V <sub>R</sub> )

(1) Pulse Width &lt; 300µs, Duty Cycle &lt;2%

## Thermal-Mechanical Specifications

Parameters	Values	Units	Conditions
T <sub>J</sub> Max. Junction Temperature Range (*)	-55 to 150	°C	
T <sub>stg</sub> Max. Storage Temperature Range	-55 to 150	°C	
R <sub>thJA</sub> Max. Thermal Resistance Junction to Ambient	65	°C/W	DC operation
R <sub>thJL</sub> Max. Thermal Resistance Junction to Lead		25	°C/W DC operation
wt Approximate Weight	0.13 (.0045)	g (oz.)	
Case Style	SOT-223		
Device Marking	2CJQH		

(\*)  $\frac{dP_{tot}}{dT_J} < \frac{1}{R_{th(j-a)}}$  thermal runaway condition for a diode on its own heatsink

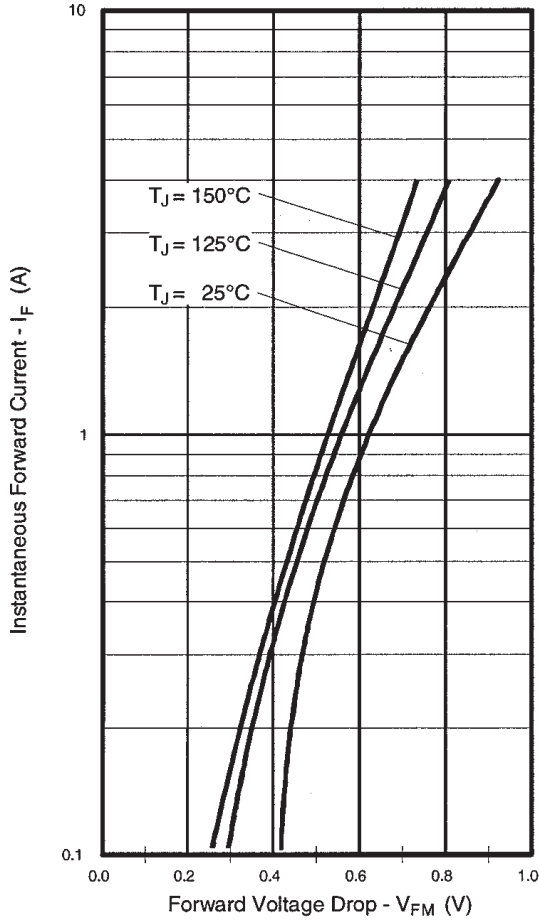

Fig. 1 - Max. Forward Voltage Drop Characteristics (Per Leg)

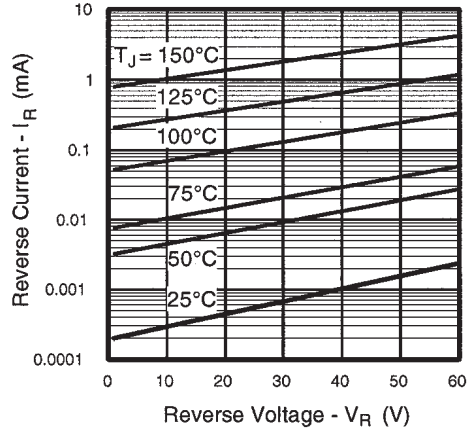

Fig. 2 - Typical Values Of Reverse Current Vs. Reverse Voltage (Per Leg)

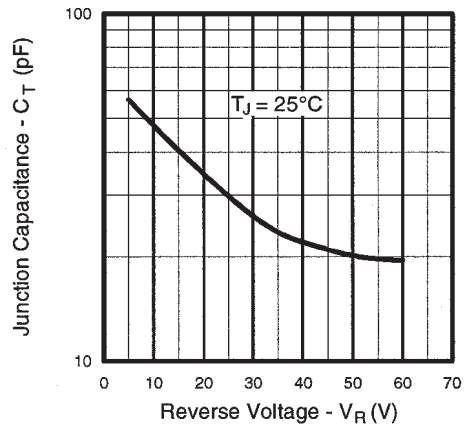

Fig. 3 - Typical Junction Capacitance Vs. Reverse Voltage (Per Leg)

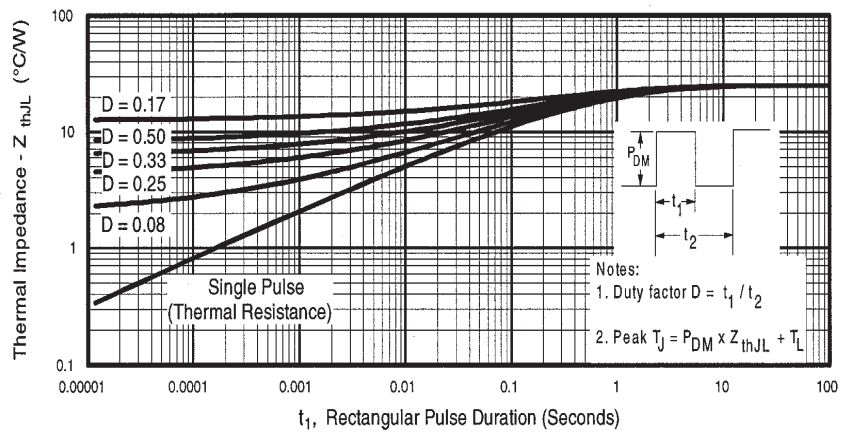

Fig. 4 - Max. Thermal Impedance  $Z_{thJC}$  Characteristics (Per Leg)

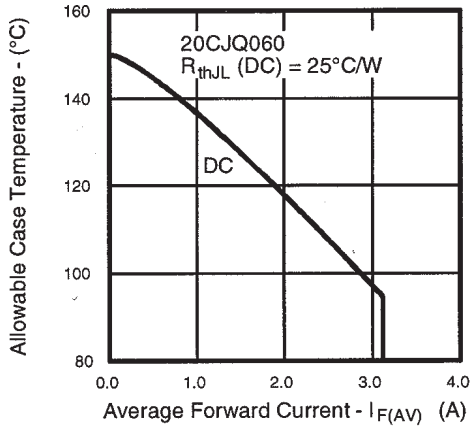

Fig. 5 - Max. Allowable Case Temperature Vs. Average Forward Current (Per Leg)

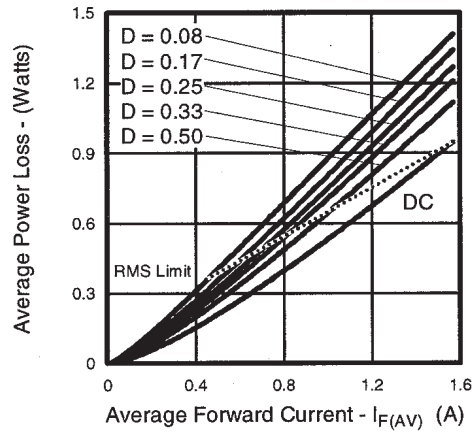

Fig. 6 - Forward Power Loss Characteristics (Per Leg)

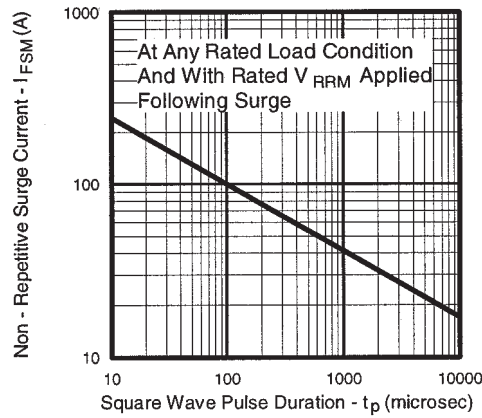

Fig. 7 - Max. Non-Repetitive Surge Current (Per Leg)

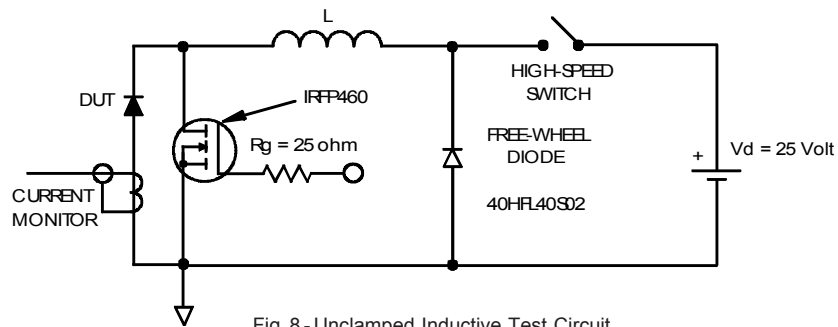

Fig. 8 - Unclamped Inductive Test Circuit

(2) Formula used:  $T_c = T_j - (Pd + Pd_{REV}) \times R_{thJC}$ ;

$Pd$  = Forward Power Loss =  $I_{F(AV)} \times V_{FM} @ (I_{F(AV)} / D)$  (see Fig. 6);

$Pd_{REV}$  = Inverse Power Loss =  $V_{R1} \times I_{R1} (1 - D)$ ;  $I_{R1} @ V_{R1} = 80\%$  rated  $V_R$

Outline Table

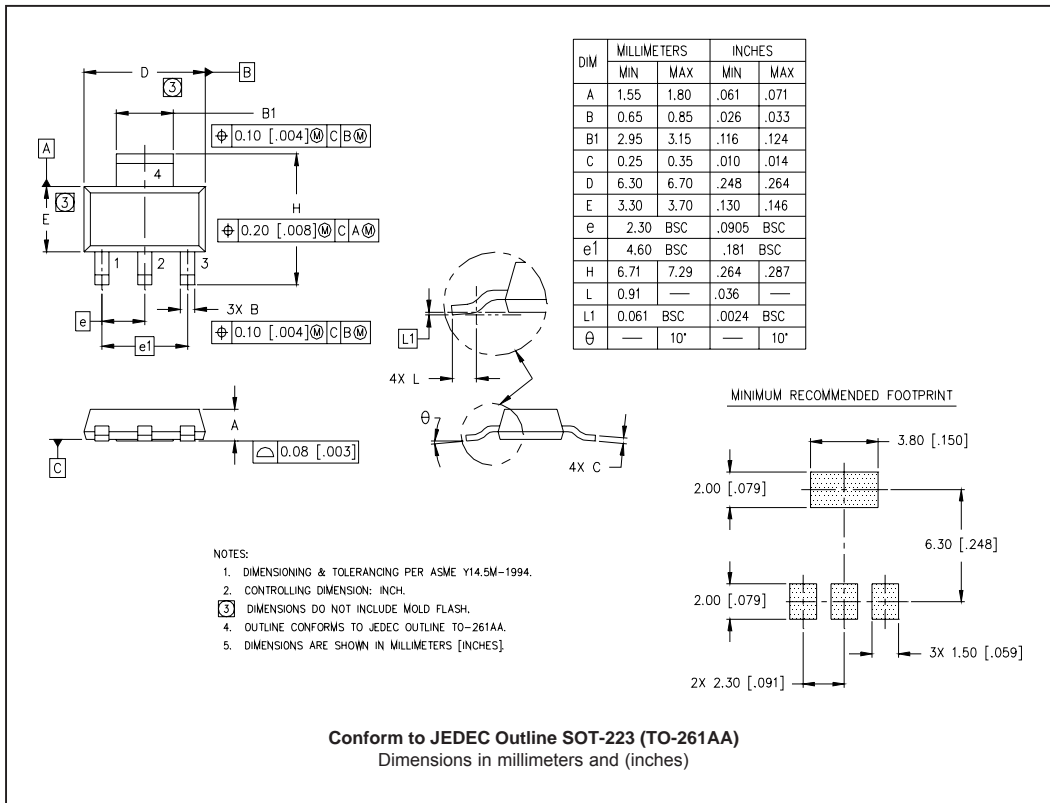

Marking Information

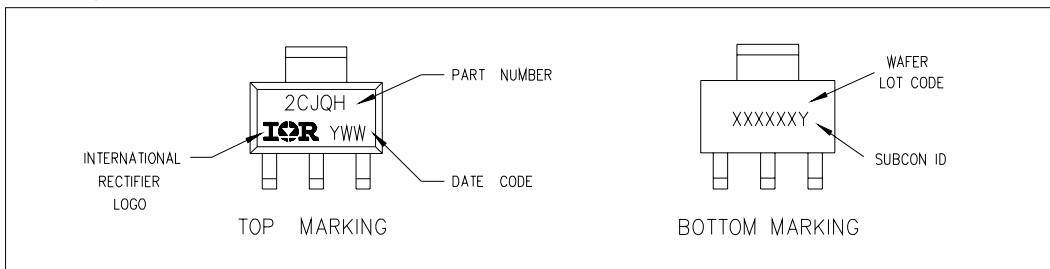

Tape and Reel Information

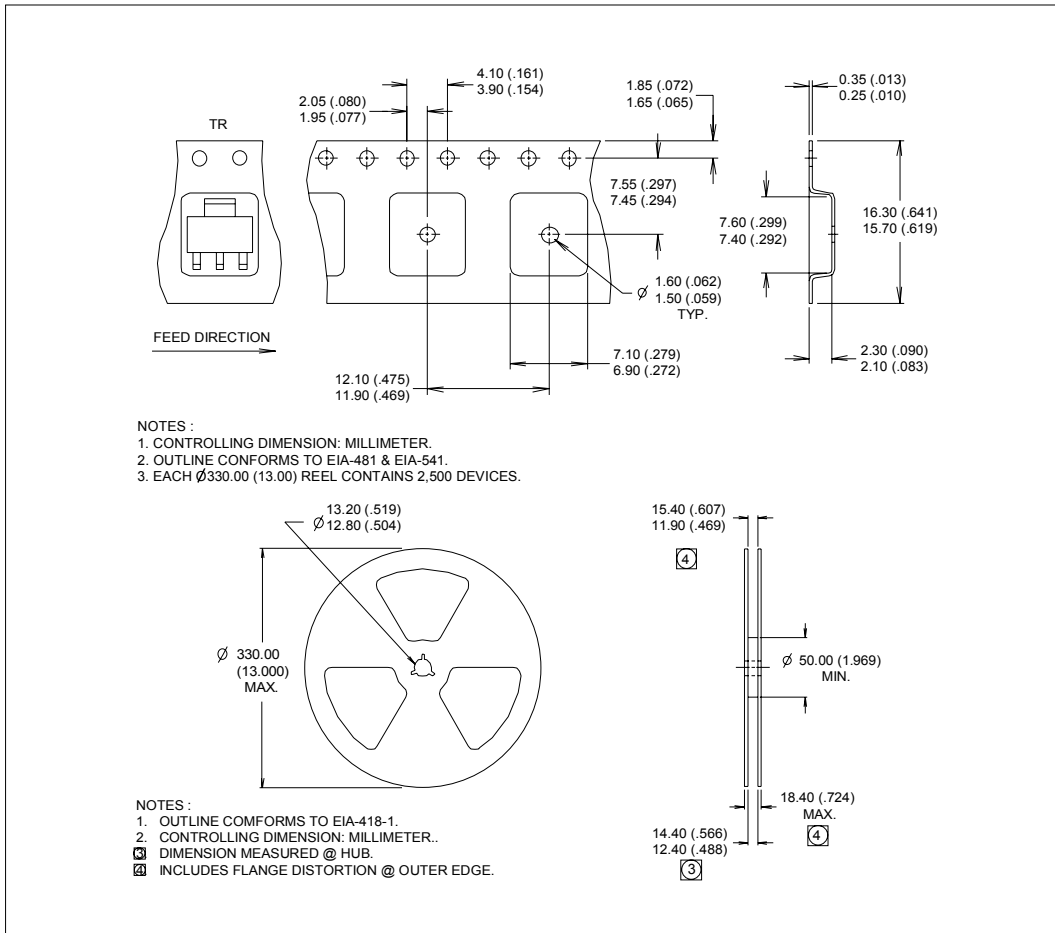

Ordering Information Table

Device Code								
	<table border="1" style="margin: auto;"> <tr> <td style="padding: 5px;">2</td> <td style="padding: 5px;">0</td> <td style="padding: 5px;">C</td> <td style="padding: 5px;">J</td> <td style="padding: 5px;">Q</td> <td style="padding: 5px;">060</td> <td style="padding: 5px;">-</td> </tr> </table>	2	0	C	J	Q	060	-
2	0	C	J	Q	060	-		
	<table style="margin: auto;"> <tr> <td style="border: 1px solid black; border-radius: 50%; padding: 2px 5px;">1</td> <td style="border: 1px solid black; border-radius: 50%; padding: 2px 5px;">2</td> <td style="border: 1px solid black; border-radius: 50%; padding: 2px 5px;">3</td> <td style="border: 1px solid black; border-radius: 50%; padding: 2px 5px;">4</td> <td style="border: 1px solid black; border-radius: 50%; padding: 2px 5px;">5</td> <td style="border: 1px solid black; border-radius: 50%; padding: 2px 5px;">6</td> <td style="border: 1px solid black; border-radius: 50%; padding: 2px 5px;">7</td> </tr> </table>	1	2	3	4	5	6	7
1	2	3	4	5	6	7		
<b>1</b>	- Current Rating (2 = 2A)							
<b>2</b>	- Schottky Rectifier Series							
<b>3</b>	- Circuit Configuration C = Common Cathode							
<b>4</b>	- Package J = SOT-223							
<b>5</b>	- Schottky "Q" Series							
<b>6</b>	- Voltage Rating (060 = 60V)							
<b>7</b>	- <ul style="list-style-type: none"> <li>• none = Standard Production</li> <li>• PbF = Lead-Free</li> </ul>							

Data and specifications subject to change without notice.  
 This product has been designed and qualified for Industrial Level.  
 Qualification Standards can be found on IR's Web site.