



# 6CWQ06FN

SCHOTTKY RECTIFIER

7 Amp

$I_{F(AV)} = 7\text{Amp}$   
 $V_R = 60\text{V}$

### Major Ratings and Characteristics

Characteristics	Values	Units
$I_{F(AV)}$ Rectangular waveform	7	A
$V_{RRM}$	60	V
$I_{FSM}$ @ tp = 5 $\mu$ s sine	490	A
$V_F$ @ 3 Apk, $T_J = 25^\circ\text{C}$ (per leg)	0.61	V
$T_J$ range	-40 to 150	$^\circ\text{C}$

### Description/ Features

The 6CWQ06FN surface mount, center tap, Schottky rectifier series has been designed for applications requiring low forward drop and small foot prints on PC board. Typical applications are in disk drives, switching power supplies, converters, free-wheeling diodes, battery charging, and reverse battery protection.

- Popular D-PAK outline
- Center tap configuration
- Small foot print, surface mountable
- Low forward voltage drop
- High frequency operation
- Guard ring for enhanced ruggedness and long term reliability

### Case Styles



D-PAK (TO-252AA)

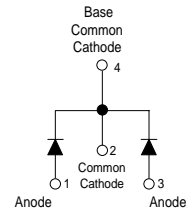

## Voltage Ratings

Part number	6CWQ06FN
V <sub>R</sub> Max. DC Reverse Voltage (V)	60
V <sub>RWM</sub> Max. Working Peak Reverse Voltage (V)	

## Absolute Maximum Ratings

Parameters	6CWQ...	Units	Conditions
I <sub>F(AV)</sub> Max. Average Forward (Per Leg) Current * See Fig. 5 (Per Device)	3.5 7	A	50% duty cycle @ T <sub>C</sub> = 133°C, rectangular wave form
I <sub>FSM</sub> Max. Peak One Cycle Non-Repetitive Surge Current * See Fig. 7	490 70	A	5μs Sine or 3μs Rect. pulse 10ms Sine or 6ms Rect. pulse
E <sub>AS</sub> Non-Repet. Avalan. Energy (Per Leg)	6.0	mJ	T <sub>J</sub> = 25 °C, I <sub>AS</sub> = 1 Amps, L = 12 mH
I <sub>AR</sub> Repetitive Avalanche Current (Per Leg)	1.0	A	Current decaying linearly to zero in 1 μsec Frequency limited by T <sub>J</sub> max. V <sub>A</sub> = 1.5 x V <sub>R</sub> typical

## Electrical Specifications

Parameters	6CWQ...	Units	Conditions
V <sub>FM</sub> Max. Forward Voltage Drop (Per Leg) * See Fig. 1 (1)	0.61	V	@ 3A T <sub>J</sub> = 25 °C
	0.76	V	@ 6A
	0.53	V	@ 3A T <sub>J</sub> = 125 °C
	0.65	V	@ 6A
I <sub>RM</sub> Max. Reverse Leakage Current (Per Leg) * See Fig. 2 (1)	2	mA	T <sub>J</sub> = 25 °C
	30	mA	T <sub>J</sub> = 125 °C
V <sub>F(TO)</sub> Threshold Voltage	0.38	V	T <sub>J</sub> = T <sub>J</sub> max.
r <sub>t</sub> Forward Slope Resistance	34.31	mΩ	
C <sub>T</sub> Typ. Junction Capacitance (Per Leg)	145	pF	V <sub>R</sub> = 5V <sub>DC</sub> (test signal range 100Khz to 1Mhz) 25°C
L <sub>S</sub> Typical Series Inductance (Per Leg)	5.0	nH	Measured lead to lead 5mm from package body
dv/dt Max. Voltage Rate of Change	10000	V/μs	(Rated V <sub>R</sub> )

(1) Pulse Width &lt; 300μs, Duty Cycle &lt;2%

## Thermal-Mechanical Specifications

Parameters	6CWQ...	Units	Conditions
T <sub>J</sub> Max. Junction Temperature Range (*)	-40 to 150	°C	
T <sub>stg</sub> Max. Storage Temperature Range	-40 to 150	°C	
R <sub>thJC</sub> Max. Thermal Resistance (Per Leg) Junction to Case (Per Device)	4.70	°C/W	DC operation * See Fig. 4
	2.35		
wt Approximate Weight	0.3(0.01)	g(oz.)	
Case Style	D-Pak		Similar to TO-252AA
Marking Device	6CWQ06FN		

(\*)  $\frac{dP_{tot}}{dT_j} < \frac{1}{R_{th(j-a)}}$  thermal runaway condition for a diode on its own heatsink

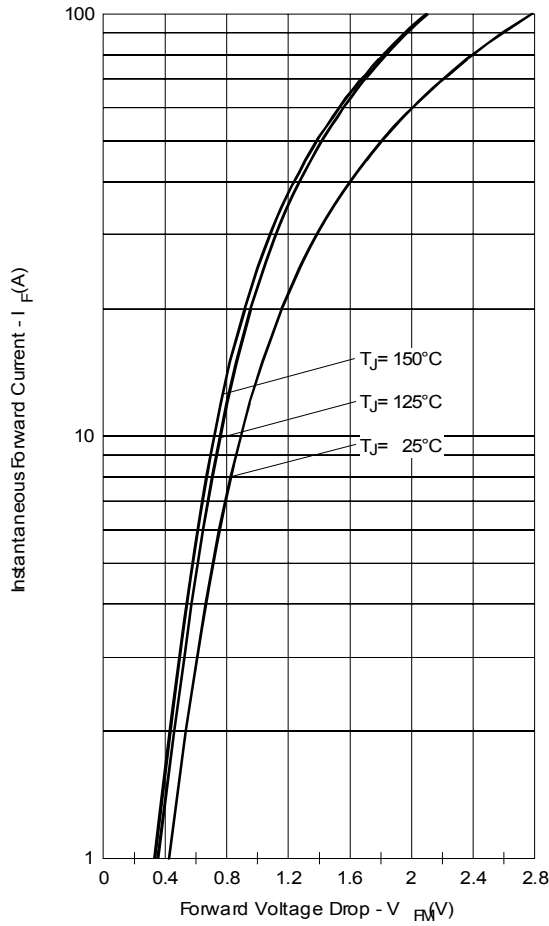

Fig. 1 - Max. Forward Voltage Drop Characteristics (Per Leg)

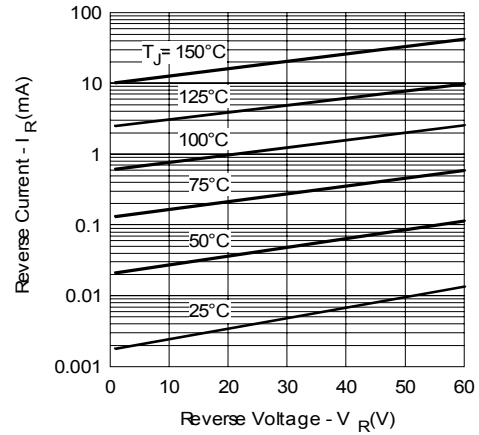

Fig. 2 - Typical Values Of Reverse Current Vs. Reverse Voltage (Per Leg)

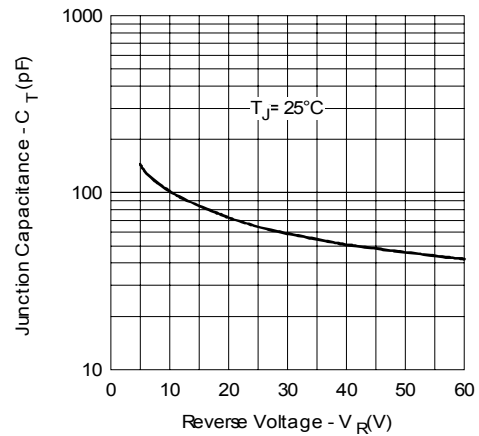

Fig. 3 - Typical Junction Capacitance Vs. Reverse Voltage (Per Leg)

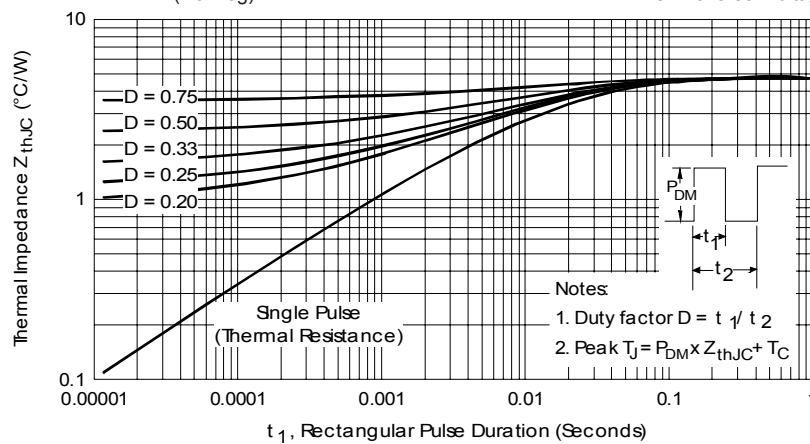

Fig. 4 - Max. Thermal Impedance  $Z_{thJC}$  Characteristics (Per Leg)

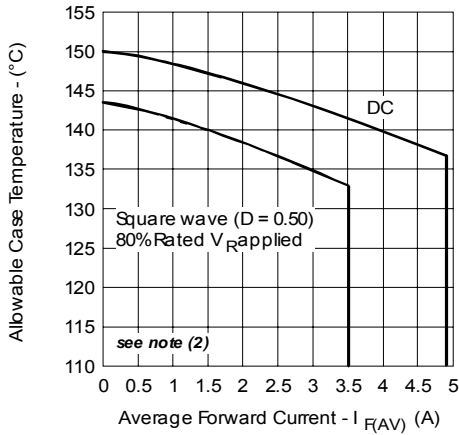

Fig. 5 - Max. Allowable Case Temperature Vs. Average Forward Current (Per Leg)

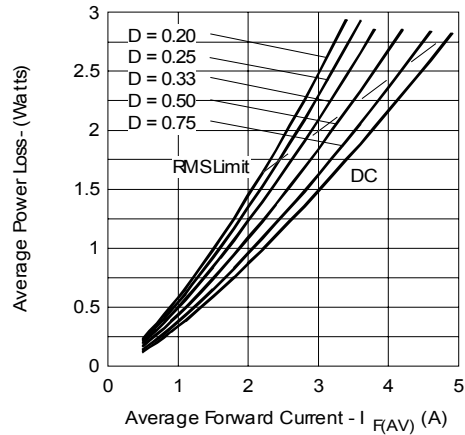

Fig. 6 - Forward Power Loss Characteristics (Per Leg)

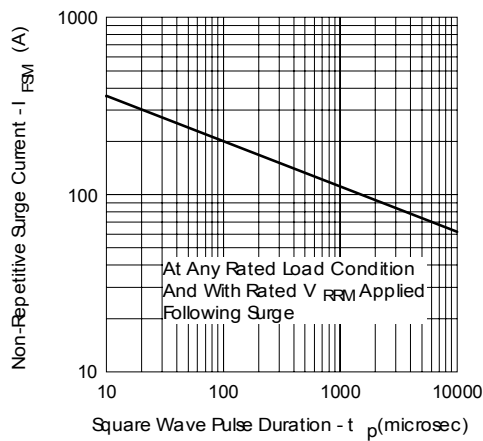
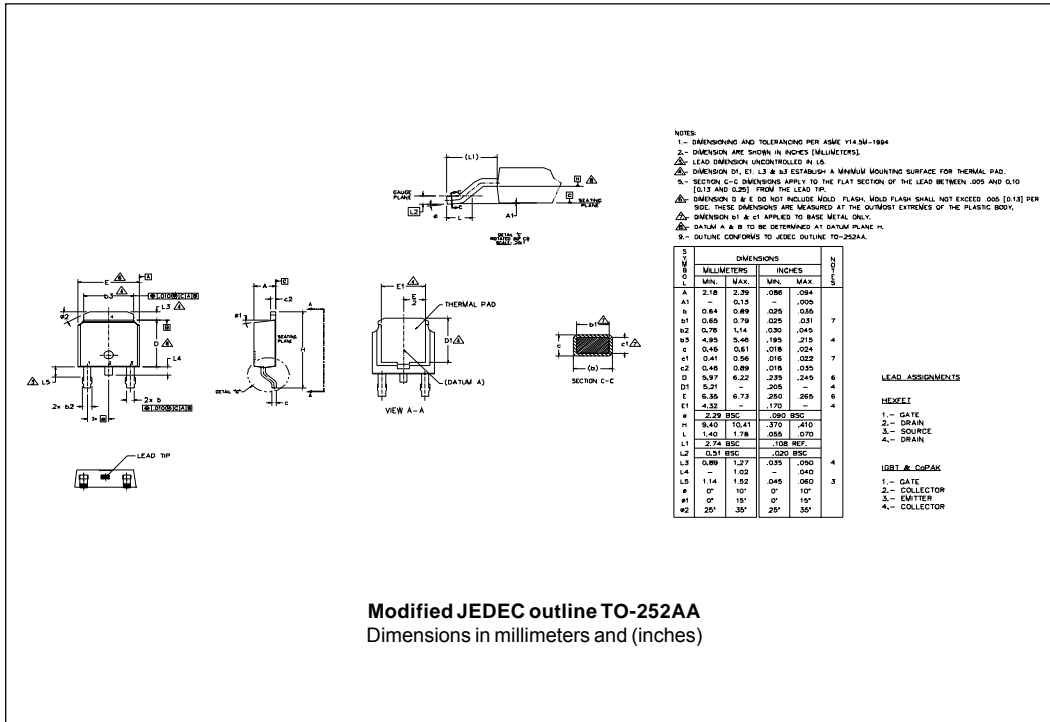

Fig. 7 - Max. Non-Repetitive Surge Current (Per Leg)

(2) Formula used:  $T_C = T_J - (Pd + Pd_{REV}) \times R_{thJC}$ ;  
 $Pd = \text{Forward Power Loss} = I_{F(AV)} \times V_{FM} @ (I_{F(AV)} / D)$  (see Fig. 6);  
 $Pd_{REV} = \text{Inverse Power Loss} = V_{R1} \times I_R (1 - D)$ ;  $I_R @ V_{R1} = 80\% \text{ rated } V_R$

Outline Table



Part Marking Information

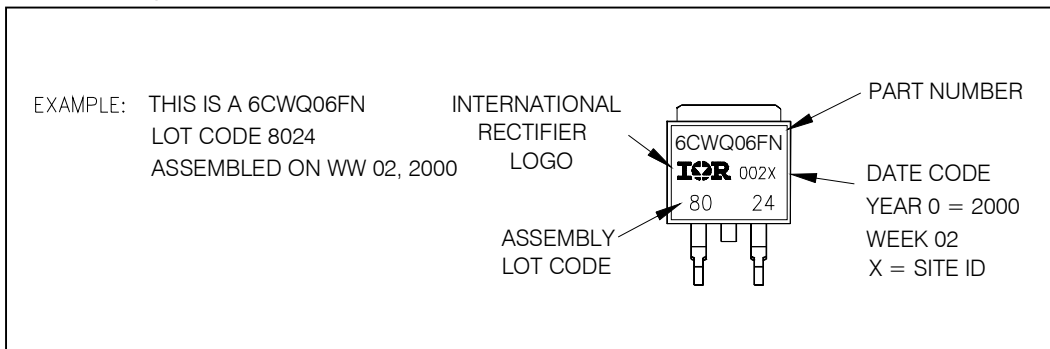

Tape & Reel Information

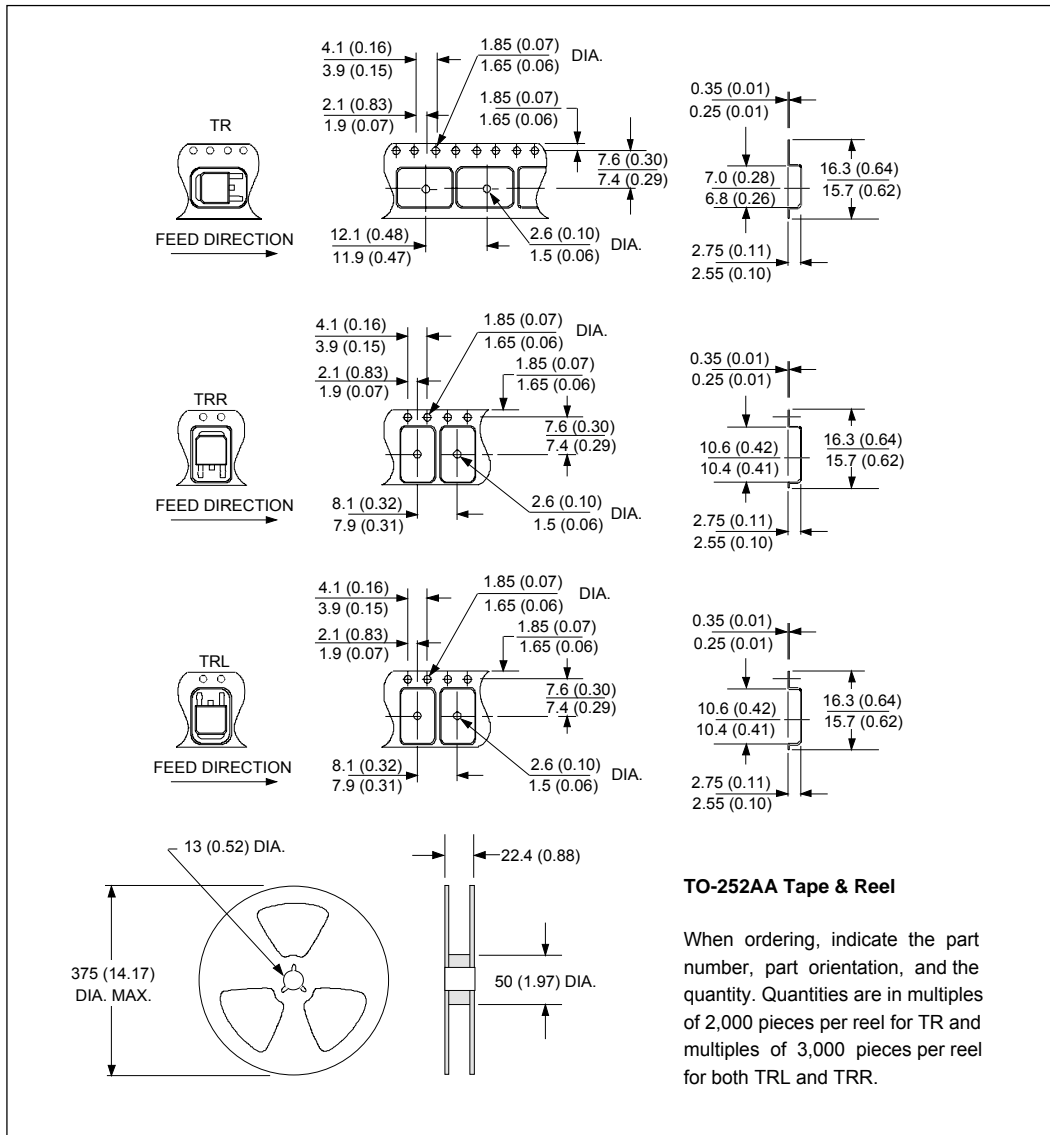

Ordering Information Table

Device Code																	
	<table border="1" style="margin: auto;"> <tr> <td style="padding: 5px;"><b>6</b></td> <td style="padding: 5px;"><b>C</b></td> <td style="padding: 5px;"><b>W</b></td> <td style="padding: 5px;"><b>Q</b></td> <td style="padding: 5px;"><b>06</b></td> <td style="padding: 5px;"><b>FN</b></td> <td style="padding: 5px;"><b>TRL</b></td> <td style="padding: 5px;"><b>-</b></td> </tr> <tr> <td style="text-align: center;">①</td> <td style="text-align: center;">②</td> <td style="text-align: center;">③</td> <td style="text-align: center;">④</td> <td style="text-align: center;">⑤</td> <td style="text-align: center;">⑥</td> <td style="text-align: center;">⑦</td> <td style="text-align: center;">⑧</td> </tr> </table>	<b>6</b>	<b>C</b>	<b>W</b>	<b>Q</b>	<b>06</b>	<b>FN</b>	<b>TRL</b>	<b>-</b>	①	②	③	④	⑤	⑥	⑦	⑧
<b>6</b>	<b>C</b>	<b>W</b>	<b>Q</b>	<b>06</b>	<b>FN</b>	<b>TRL</b>	<b>-</b>										
①	②	③	④	⑤	⑥	⑦	⑧										
<b>1</b>	- Current Rating (7A)																
<b>2</b>	- C = Center Tap Configuration																
<b>3</b>	- Package Identifier W = D-Pak																
<b>4</b>	- Schottky "Q" Series																
<b>5</b>	- Voltage Rating (06 = 60V)																
<b>6</b>	- FN = TO-252AA																
<b>7</b>	- <ul style="list-style-type: none"> <li>• none = Tube (50 pieces)</li> <li>• TR = Tape &amp; Reel</li> <li>• TRL = Tape &amp; Reel (Left Oriented)</li> <li>• TRR = Tape &amp; Reel (Right Oriented)</li> </ul>																
<b>8</b>	- <ul style="list-style-type: none"> <li>• none = Standard Production</li> <li>• PbF = Lead-Free</li> </ul>																

Data and specifications subject to change without notice.  
 This product has been designed and qualified for AEC Q101 Level.  
 Qualification Standards can be found on IR's Web site.