

IRF7413PbF

HEXFET® Power MOSFET

- Generation V Technology
- Ultra Low On-Resistance
- N-Channel Mosfet
- Surface Mount
- Available in Tape & Reel
- Dynamic dv/dt Rating
- Fast Switching
- 100% R_G Tested
- Lead-Free

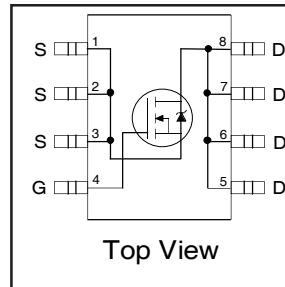

$$V_{DS} = 30V$$

$$R_{DS(on)} = 0.011\Omega$$

Description

Fifth Generation HEXFETs from International Rectifier utilize advanced processing techniques to achieve extremely low on-resistance per silicon area. This benefit, combined with the fast switching speed and ruggedized device design that HEXFET Power MOSFETs are well known for, provides the designer with an extremely efficient and reliable device for use in a wide variety of applications.

The SO-8 has been modified through a customized leadframe for enhanced thermal characteristics and multiple-die capability making it ideal in a variety of power applications. With these improvements, multiple devices can be used in an application with dramatically reduced board space. The package is designed for vapor phase, infra red, or wave soldering techniques. Power dissipation of greater than 0.8W is possible in a typical PCB mount application.

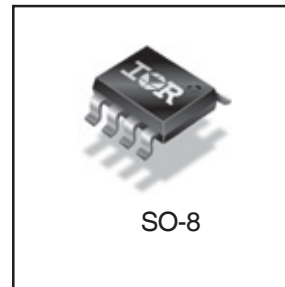

Absolute Maximum Ratings

Symbol	Parameter	Max	Units
V _{DS}	Drain-to-Source Voltage	30	V
V _{GS}	Gate-to-Source Voltage	± 20	
I _D @ T _A = 25°C	Continuous Drain Current, V _{GS} @ 10V	13	A
I _D @ T _A = 70°C	Continuous Drain Current, V _{GS} @ 10V	9.2	
I _{DM}	Pulsed Drain Current ①	58	
P _D @ T _A = 25°C	Power Dissipation	2.5	W
	Linear Derating Factor	0.02	mW/°C
E _{AS}	Single Pulse Avalanche Energy ②	260	mJ
dv/dt	Peak Diode Recovery dv/dt ③	5.0	V/ns
T _J , T _{STG}	Junction and Storage Temperature Range	-55 to +150	°C

Thermal Resistance Ratings

Symbol	Parameter	Typ	Max	Units
R _{θJL}	Junction-to-Drain Lead	—	20	°C/W
R _{θJA}	Junction-to-Ambient ④	—	50	

Electrical Characteristics @ T_J = 25°C (unless otherwise specified)

Symbol	Parameter	Min	Typ	Max	Units	Conditions
V _{(BR)DSS}	Drain-to-Source Breakdown Voltage	30	—	—	V	V _{GS} = 0V, I _D = 250μA
ΔV _{(BR)DSS/ΔT_J}	Breakdown Voltage Temp. Coefficient	—	0.034	—	V/°C	Reference to 25°C, I _D = 1mA
R _{DS(on)}	Static Drain-to-Source On-Resistance	—	—	0.011	Ω	V _{GS} = 10V, I _D = 7.3A ④
		—	—	0.018		V _{GS} = 4.5V, I _D = 3.7A ④
V _{GS(th)}	Gate Threshold Voltage	1.0	—	3.0	V	V _{DS} = V _{GS} , I _D = 250μA
g _{fs}	Forward Transconductance	10	—	—	S	V _{DS} = 10V, I _D = 3.7A
I _{DSS}	Drain-to-Source Leakage Current	—	—	12	μA	V _{DS} = 30V, V _{GS} = 0V
		—	—	25		V _{DS} = 24V, V _{GS} = 0V, T _J = 125°C
I _{GSS}	Gate-to-Source Forward Leakage	—	—	-100	nA	V _{GS} = -20V
	Gate-to-Source Reverse Leakage	—	—	100		V _{GS} = 20V
Q _g	Total Gate Charge	—	52	79	nC	I _D = 7.3A
Q _{gs}	Gate-to-Source Charge	—	6.1	9.2		V _{DS} = 24V
Q _{gd}	Gate-to-Drain ("Miller") Charge	—	16	23		V _{GS} = 10V, See Fig. 6 and 9 ④
R _G	Gate Resistance	—	—	3.7	Ω	
t _{d(on)}	Turn-On Delay Time	—	8.6	—	ns	V _{DD} = 15V
t _r	Rise Time	—	50	—		I _D = 7.3A
t _{d(off)}	Turn-Off Delay Time	—	52	—		R _G = 6.2 Ω
t _f	Fall Time	—	46	—		R _G = 2.0Ω, See Fig. 10 ④
C _{iss}	Input Capacitance	—	1800	—	pF	V _{GS} = 0V
C _{oss}	Output Capacitance	—	680	—		V _{DS} = 25V
C _{rss}	Reverse Transfer Capacitance	—	240	—		f = 1.0MHz, See Fig. 5

Source-Drain Ratings and Characteristics

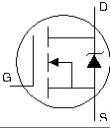
Symbol	Parameter	Min.	Typ.	Max.	Units	Conditions
I _S	Continuous Source Current (Body Diode)	—	—	3.1	A	MOSFET symbol showing the integral reverse p-n junction diode. 
I _{SM}	Pulsed Source Current (Body Diode) ①	—	—	58		
V _{SD}	Diode Forward Voltage	—	—	1.0	V	T _J = 25°C, I _S = 7.3A, V _{GS} = 0V ③
t _{rr}	Reverse Recovery Time	—	74	110	ns	T _J = 25°C, I _F = 7.3A
Q _{rr}	Reverse Recovery Charge	—	200	300	nC	di/dt = 100A/μs ③

Notes:

① Repetitive rating; pulse width limited by max. junction temperature. (See fig. 11)

② Starting T_J = 25°C, L = 9.8mH
R_G = 25Ω, I_{AS} = 7.3A. (See Figure 12)

③ I_{SD} ≤ 7.3A, di/dt ≤ 100A/μs, V_{DD} ≤ V_{(BR)DSS},
T_J ≤ 150°C

④ Pulse width ≤ 300μs; duty cycle ≤ 2%.

⑤ Surface mounted on FR-4 board

⑥ R_θ is measured at T_J approximately 90°C

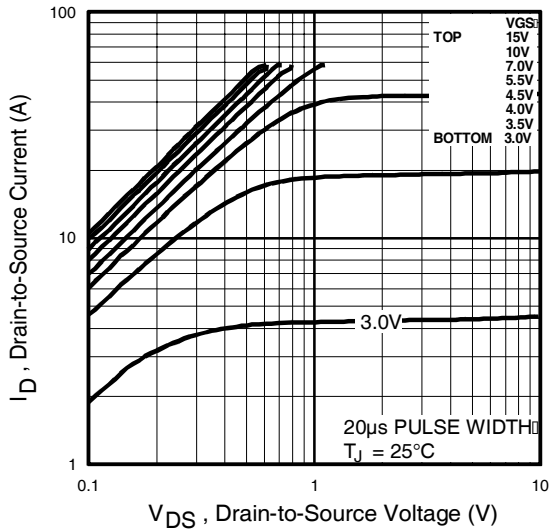

Fig 1. Typical Output Characteristics

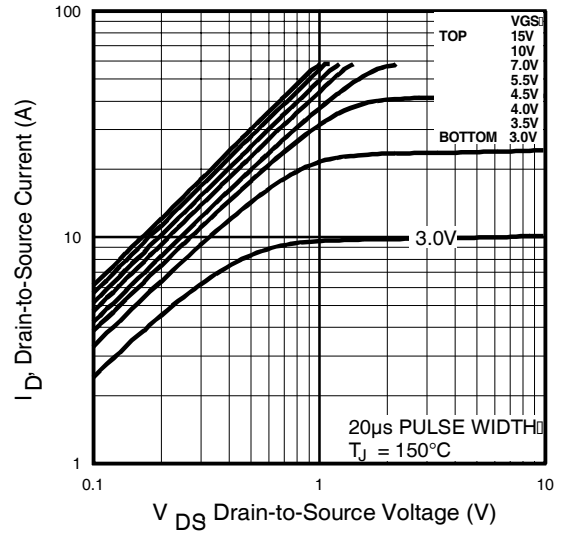

Fig 2. Typical Output Characteristics

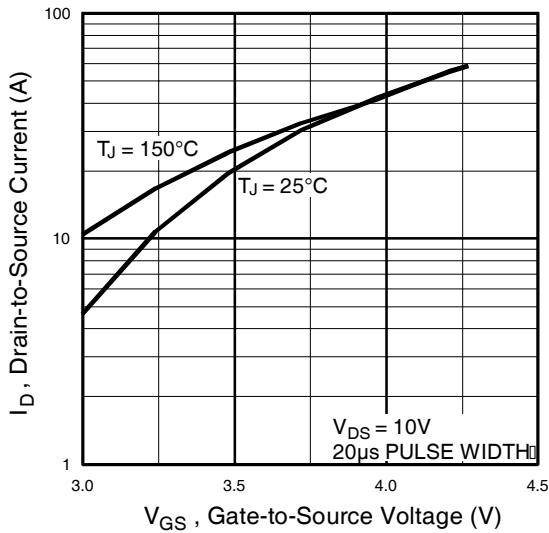

Fig 3. Typical Transfer Characteristics

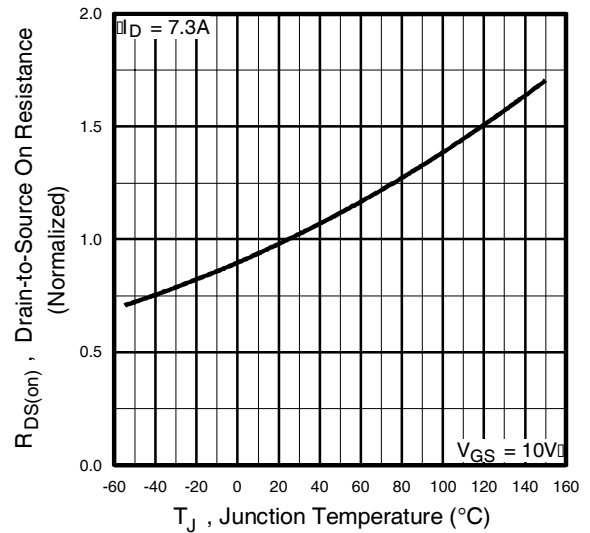

Fig 4. Normalized On-Resistance Vs. Temperature

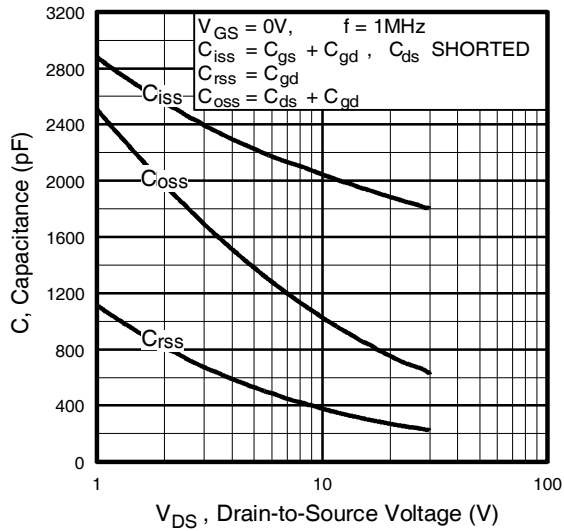

Fig 5. Typical Capacitance Vs. Drain-to-Source Voltage

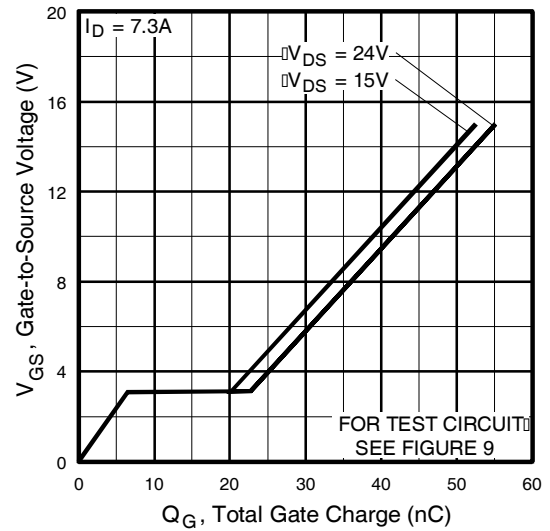

Fig 6. Typical Gate Charge Vs. Gate-to-Source Voltage

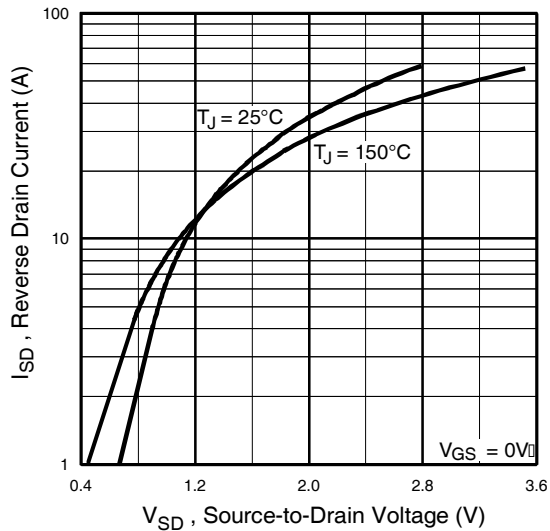

Fig 7. Typical Source-Drain Diode Forward Voltage

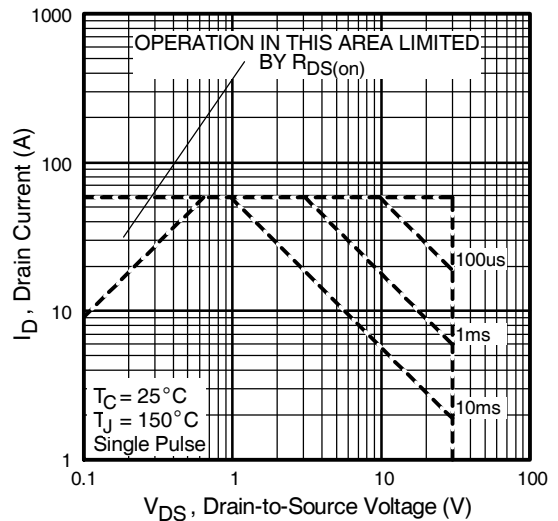

Fig 8. Maximum Safe Operating Area

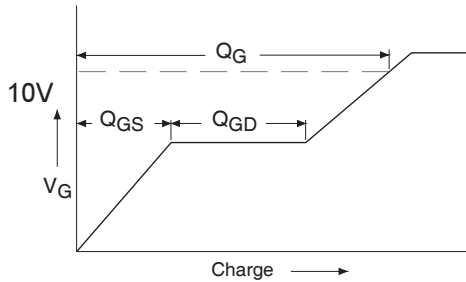

Fig 9a. Basic Gate Charge Waveform

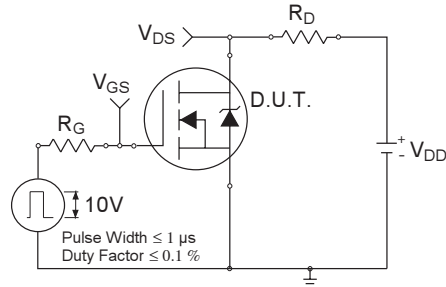

Fig 10a. Switching Time Test Circuit

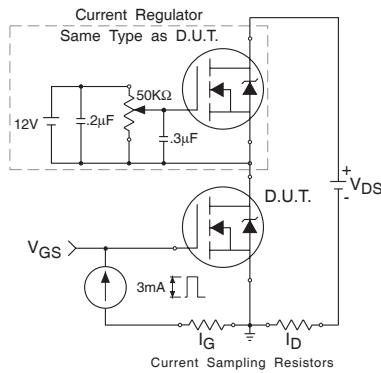

Fig 9b. Gate Charge Test Circuit

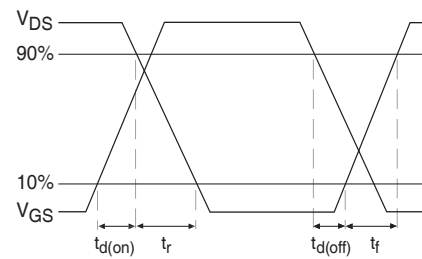

Fig 10b. Switching Time Waveforms

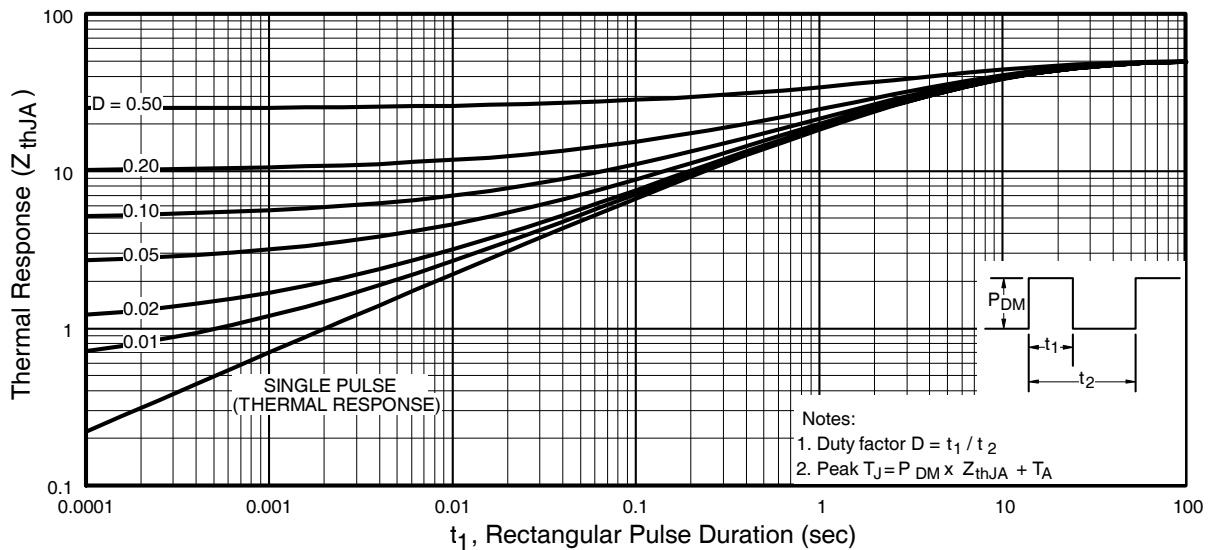

Fig 11. Maximum Effective Transient Thermal Impedance, Junction-to-Ambient

IRF7413PbF

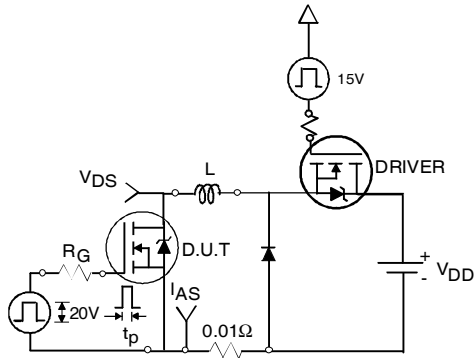

Fig 12a. Unclamped Inductive Test Circuit

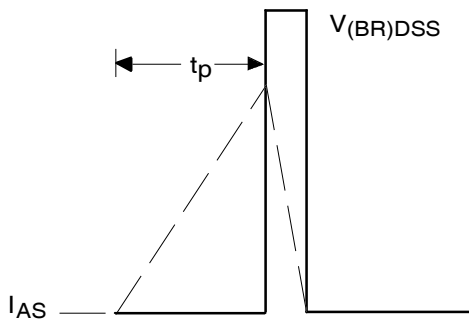

Fig 12b. Unclamped Inductive Waveforms

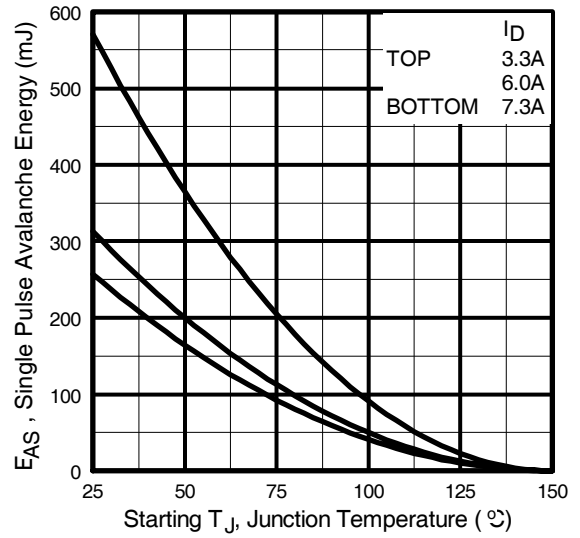

Fig 12c. Maximum Avalanche Energy Vs. Drain Current

Peak Diode Recovery dv/dt Test Circuit

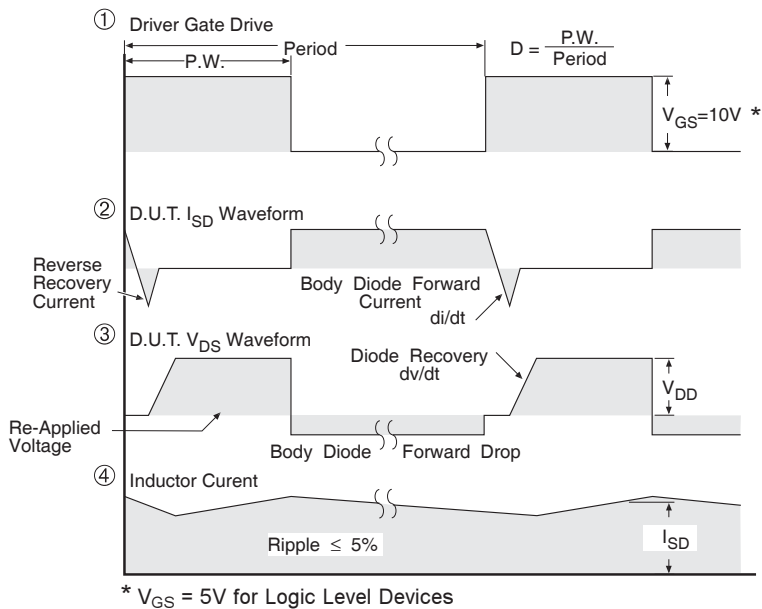
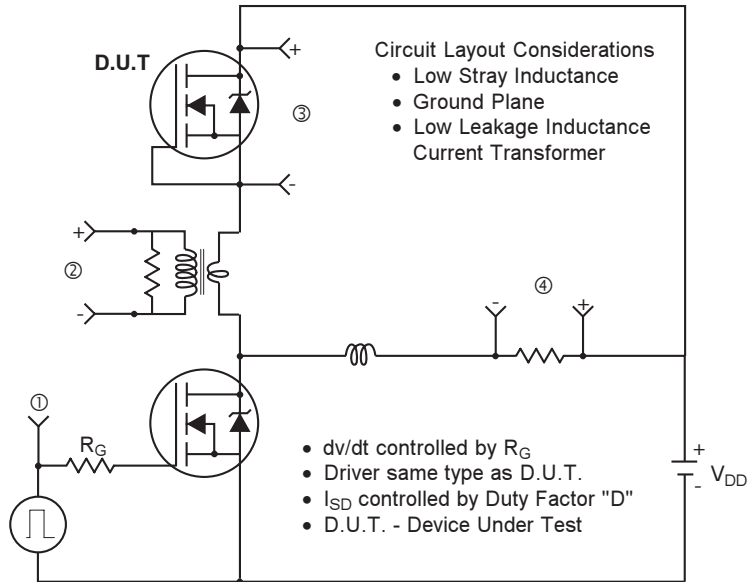
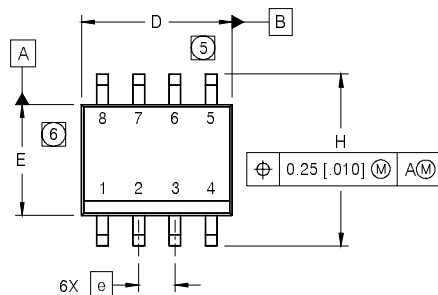

Fig 13. For N-Channel HEXFETS

IRF7413PbF

SO-8 Package Outline

Dimensions are shown in millimeters (inches)



DIM	INCHES		MILLIMETERS	
	MIN	MAX	MIN	MAX
A	.0532	.0688	1.35	1.75
A1	.0040	.0098	0.10	0.25
b	.013	.020	0.33	0.51
c	.0075	.0098	0.19	0.25
D	.189	.1968	4.80	5.00
E	.1497	.1574	3.80	4.00
e	.050 BASIC		1.27 BASIC	
e1	.025 BASIC		0.635 BASIC	
H	.2284	.2440	5.80	6.20
K	.0099	.0196	0.25	0.50
L	.016	.050	0.40	1.27
y	0°	8°	0°	8°

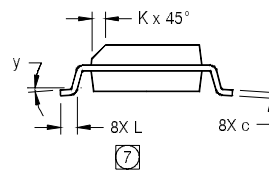
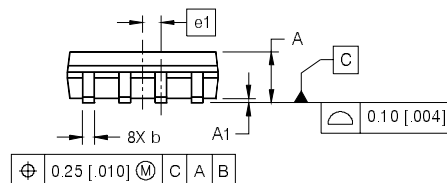

NOTES:

- DIMENSIONING & TOLERANCING PER ASME Y14.5M-1994.
- CONTROLLING DIMENSION: MILLIMETER
- DIMENSIONS ARE SHOWN IN MILLIMETERS [INCHES].
- OUTLINE CONFORMS TO JEDEC OUTLINE MS-012AA.
- (5) DIMENSION DOES NOT INCLUDE MOLD PROTRUSIONS. MOLD PROTRUSIONS NOT TO EXCEED 0.15 [0.006].
- (6) DIMENSION DOES NOT INCLUDE MOLD PROTRUSIONS. MOLD PROTRUSIONS NOT TO EXCEED 0.25 [0.10].
- (7) DIMENSION IS THE LENGTH OF LEAD FOR SOLDERING TO A SUBSTRATE.

FOOTPRINT

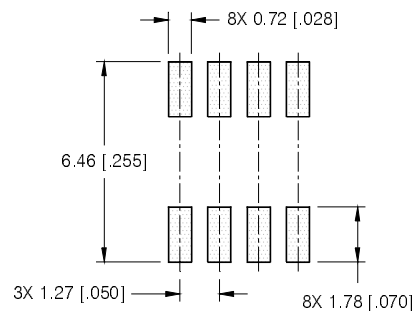

SO-8 Part Marking

EXAMPLE: THIS IS AN IRF7101 (MOSFET)

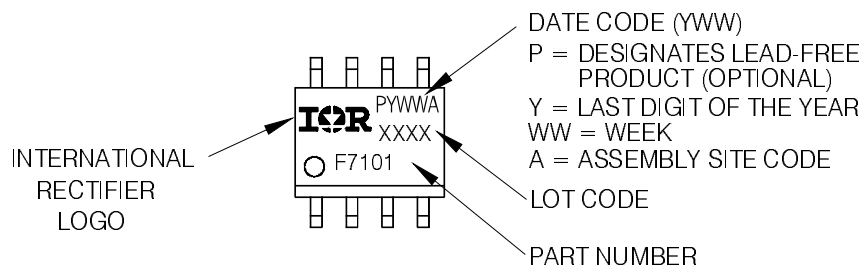

Note: For the most current drawing please refer to IR website at <http://www.irf.com/package/>
www.irf.com

SO-8 Tape and Reel

Dimensions are shown in millimeters (inches)

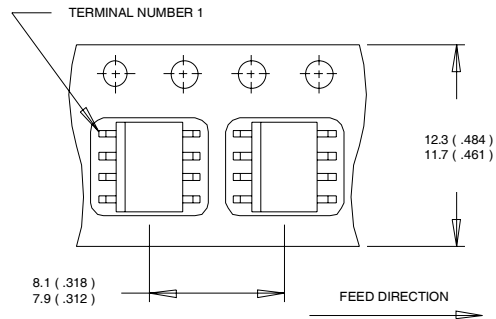

- NOTES:
1. CONTROLLING DIMENSION : MILLIMETER.
 2. ALL DIMENSIONS ARE SHOWN IN MILLIMETERS(INCHES).
 3. OUTLINE CONFORMS TO EIA-481 & EIA-541.

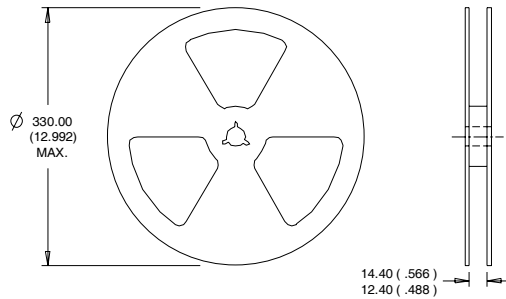

- NOTES:
1. CONTROLLING DIMENSION : MILLIMETER.
 2. OUTLINE CONFORMS TO EIA-481 & EIA-541.

Note: For the most current drawing please refer to IR website at <http://www.irf.com/package/>

Data and specifications subject to change without notice.
 This product has been designed and qualified for the Consumer market.
 Qualification Standards can be found on IR's Web site.

International
IR Rectifier

IR WORLD HEADQUARTERS: 233 Kansas St., El Segundo, California 90245, USA Tel: (310) 252-7105
 TAC Fax: (310) 252-7903

Visit us at www.irf.com for sales contact information. 02/2008

Mouser Electronics

Authorized Distributor

Click to View Pricing, Inventory, Delivery & Lifecycle Information:

[International Rectifier:](#)

[IRF7413GTRPBF](#)