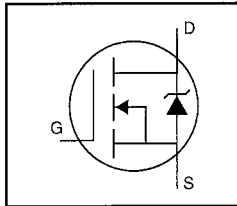


## HEXFET® Power MOSFET

- Dynamic dv/dt Rating
- Repetitive Avalanche Rated
- Isolated Central Mounting Hole
- Fast Switching
- Ease of Paralleling
- Simple Drive Requirements



$$V_{DSS} = 250V$$

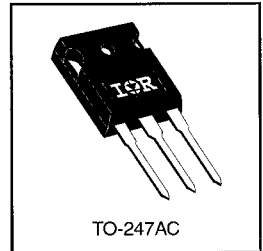
$$R_{DS(on)} = 0.14\Omega$$

$$I_D = 23A$$

## Description

Third Generation HEXFETs from International Rectifier provide the designer with the best combination of fast switching, ruggedized device design, low on-resistance and cost-effectiveness.

The TO-247 package is preferred for commercial–industrial applications where higher power levels preclude the use of TO-220 devices. The TO-247 is similar but superior to the earlier TO-218 package because of its isolated mounting hole. It also provides greater creepage distance between pins to meet the requirements of most safety specifications.



DATA SHEETS

## Absolute Maximum Ratings

Parameter	Max.	Units
$I_D @ T_C = 25^\circ\text{C}$	Continuous Drain Current, $V_{GS} @ 10\text{ V}$	23
$I_D @ T_C = 100^\circ\text{C}$	Continuous Drain Current, $V_{GS} @ 10\text{ V}$	15
$I_{DM}$	Pulsed Drain Current ①	92
$P_D @ T_C = 25^\circ\text{C}$	Power Dissipation	190
	Linear Derating Factor	1.5
$V_{GS}$	Gate-to-Source Voltage	$\pm 20$
$E_{AS}$	Single Pulse Avalanche Energy ②	410
$I_{AR}$	Avalanche Current ①	23
$E_{AR}$	Repetitive Avalanche Energy ①	19
dv/dt	Peak Diode Recovery dv/dt ③	4.8
$T_J$ $T_{STG}$	Operating Junction and Storage Temperature Range	-55 to +150
	Soldering Temperature, for 10 seconds	300 (1.6mm from case)
	Mounting Torque, 6-32 or M3 screw	10 lbf•in (1.1 N•m)

## Thermal Resistance

Parameter	Min.	Typ.	Max.	Units
$R_{\theta JC}$	—	—	0.65	°C/W
$R_{\theta CS}$	—	0.24	—	
$R_{\theta JA}$	—	—	40	

**Electrical Characteristics @ T<sub>J</sub> = 25°C (unless otherwise specified)**

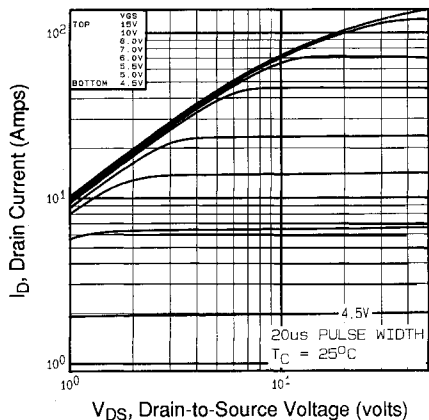
	Parameter	Min.	Typ.	Max.	Units	Test Conditions
V <sub>(BR)DSS</sub>	Drain-to-Source Breakdown Voltage	250	—	—	V	V <sub>GS</sub> =0V, I <sub>D</sub> =250μA
ΔV <sub>(BR)DSS</sub> /ΔT <sub>J</sub>	Breakdown Voltage Temp. Coefficient	—	0.39	—	V/°C	Reference to 25°C, I <sub>D</sub> =1mA
R <sub>DS(on)</sub>	Static Drain-to-Source On-Resistance	—	—	0.14	Ω	V <sub>DS</sub> =10V, I <sub>D</sub> =14A ④
V <sub>GS(th)</sub>	Gate Threshold Voltage	2.0	—	4.0	V	V <sub>DS</sub> =V <sub>GS</sub> , I <sub>D</sub> =250μA
g <sub>fs</sub>	Forward Transconductance	11	—	—	S	V <sub>DS</sub> =50V, I <sub>D</sub> =14A ④
I <sub>DSS</sub>	Drain-to-Source Leakage Current	—	—	25	μA	V <sub>DS</sub> =250V, V <sub>GS</sub> =0V
		—	—	250		V <sub>DS</sub> =200V, V <sub>GS</sub> =0V, T <sub>J</sub> =125°C
I <sub>GSS</sub>	Gate-to-Source Forward Leakage	—	—	100	nA	V <sub>GS</sub> =20V
	Gate-to-Source Reverse Leakage	—	—	-100		V <sub>GS</sub> =-20V
Q <sub>g</sub>	Total Gate Charge	—	—	140	nC	I <sub>D</sub> =23A
Q <sub>gs</sub>	Gate-to-Source Charge	—	—	24		V <sub>DS</sub> =200V
Q <sub>gd</sub>	Gate-to-Drain ("Miller") Charge	—	—	71		V <sub>GS</sub> =10V See Fig. 6 and 13 ④
t <sub>d(on)</sub>	Turn-On Delay Time	—	15	—	ns	V <sub>DD</sub> =125V
t <sub>r</sub>	Rise Time	—	63	—		I <sub>D</sub> =23A
t <sub>d(off)</sub>	Turn-Off Delay Time	—	74	—		R <sub>G</sub> =6.2Ω
t <sub>f</sub>	Fall Time	—	50	—		R <sub>D</sub> =5.4Ω See Figure 10 ④
L <sub>D</sub>	Internal Drain Inductance	—	5.0	—	nH	Between lead, 6 mm (0.25in.) from package and center of die contact
L <sub>S</sub>	Internal Source Inductance	—	13	—		
C <sub>ISS</sub>	Input Capacitance	—	2700	—	pF	V <sub>GS</sub> =0V
C <sub>OSS</sub>	Output Capacitance	—	620	—		V <sub>DS</sub> =25V
C <sub>RSS</sub>	Reverse Transfer Capacitance	—	180	—		f=1.0MHz See Figure 5


**Source-Drain Ratings and Characteristics**

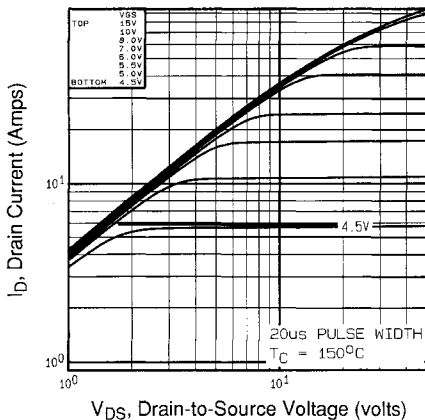
	Parameter	Min.	Typ.	Max.	Units	Test Conditions
I <sub>S</sub>	Continuous Source Current (Body Diode)	—	—	23	A	MOSFET symbol showing the integral reverse p-n junction diode.
I <sub>SM</sub>	Pulsed Source Current (Body Diode) ①	—	—	92		
V <sub>SD</sub>	Diode Forward Voltage	—	—	1.8	V	T <sub>J</sub> =25°C, I <sub>S</sub> =23A, V <sub>GS</sub> =0V ④
t <sub>rr</sub>	Reverse Recovery Time	—	370	560	ns	T <sub>J</sub> =25°C, I <sub>F</sub> =23A
Q <sub>rr</sub>	Reverse Recovery Charge	—	4.6	6.9	μC	di/dt=100A/μs ④
t <sub>on</sub>	Forward Turn-On Time	Intrinsic turn-on time is negligible (turn-on is dominated by L <sub>S</sub> +L <sub>D</sub> )				

**Notes:**

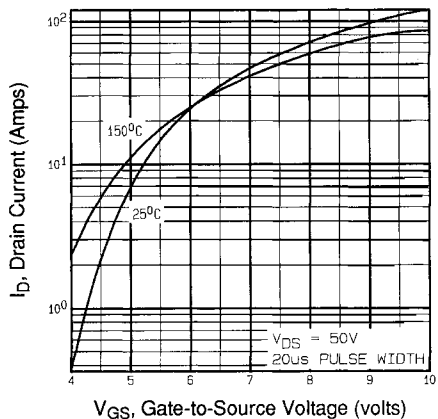
- ① Repetitive rating; pulse width limited by max. junction temperature (See Figure 11)
- ② V<sub>DD</sub>=50V, starting T<sub>J</sub>=25°C, L=1.2mH R<sub>G</sub>=25Ω, I<sub>AS</sub>=23A (See Figure 12)
- ③ I<sub>SD</sub>≤23A, di/dt≤180A/μs, V<sub>DD</sub>≤V<sub>(BR)DSS</sub>, T<sub>J</sub>≤150°C
- ④ Pulse width ≤ 300 μs; duty cycle ≤2%.



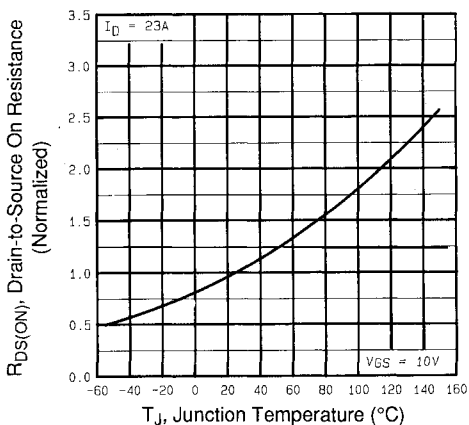
**Fig 1.** Typical Output Characteristics,  
 $T_C = 25^\circ\text{C}$



**Fig 2.** Typical Output Characteristics,  
 $T_C = 150^\circ\text{C}$

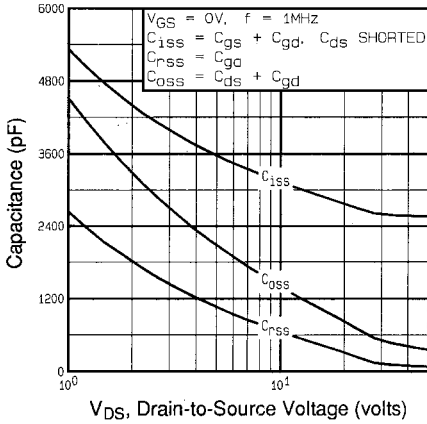


**Fig 3.** Typical Transfer Characteristics

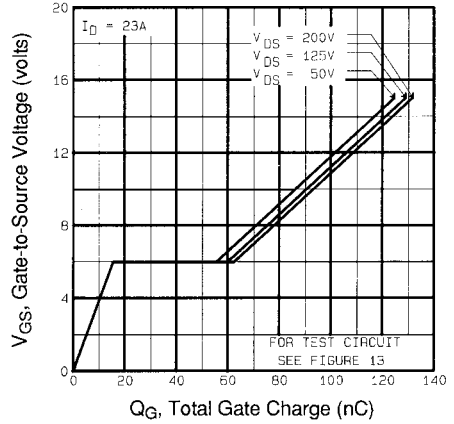


**Fig 4.** Normalized On-Resistance  
Vs. Temperature

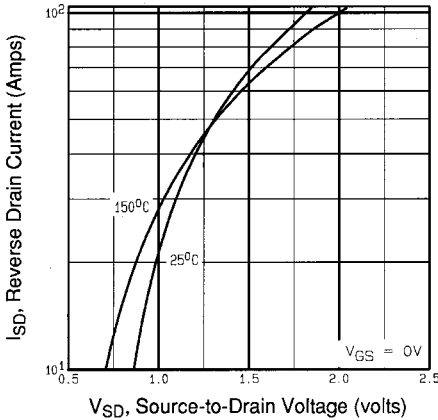
DATA SHEETS



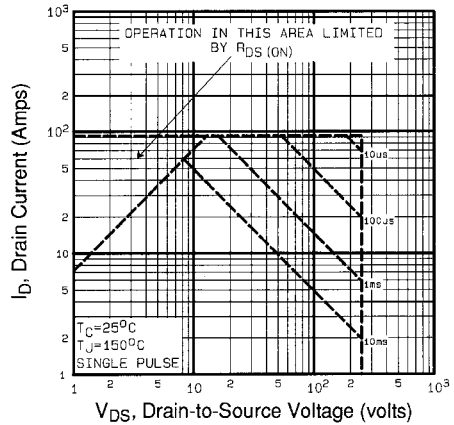
**Fig 5.** Typical Capacitance Vs. Drain-to-Source Voltage



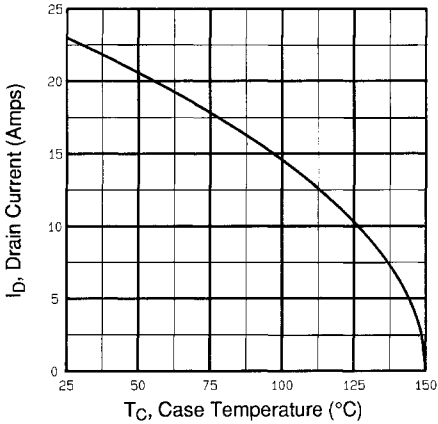
**Fig 6.** Typical Gate Charge Vs. Gate-to-Source Voltage



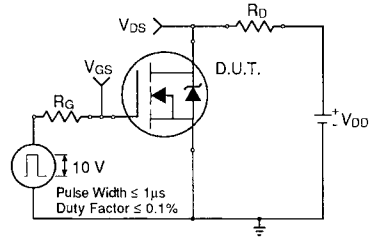
**Fig 7.** Typical Source-Drain Diode Forward Voltage



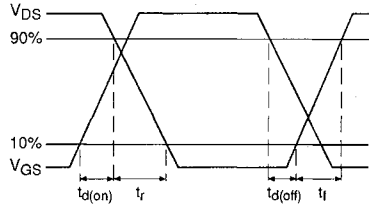
**Fig 8.** Maximum Safe Operating Area



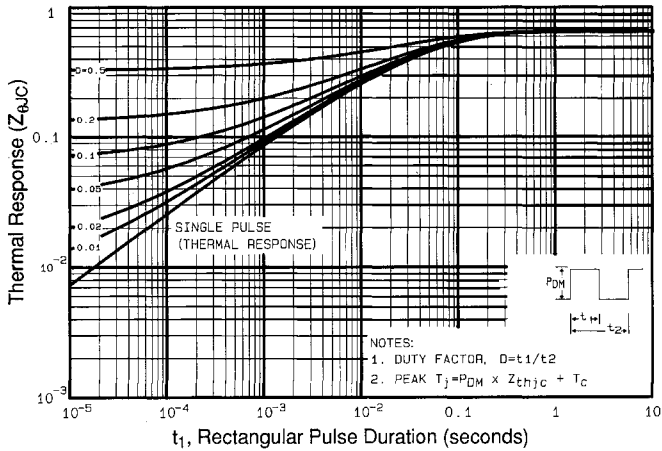
**Fig 9.** Maximum Drain Current Vs. Case Temperature



**Fig 10a.** Switching Time Test Circuit

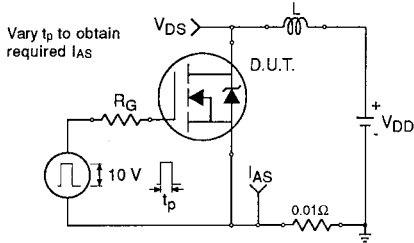


**Fig 10b.** Switching Time Waveforms

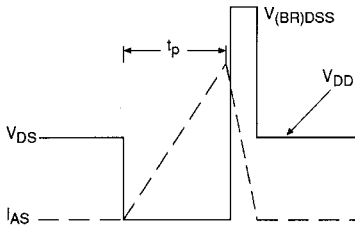


**Fig 11.** Maximum Effective Transient Thermal Impedance, Junction-to-Case

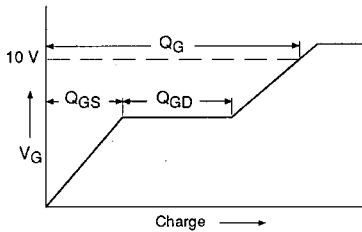
DATA SHEETS



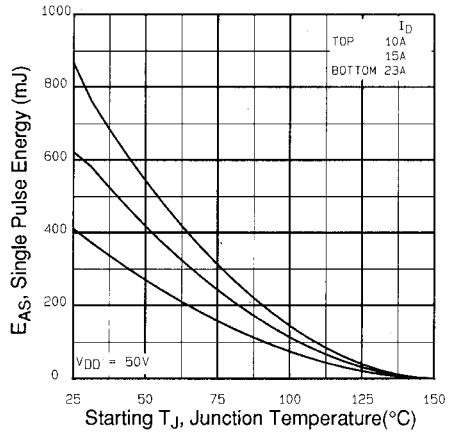
**Fig 12a.** Unclamped Inductive Test Circuit



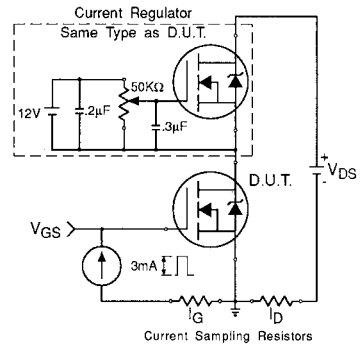
**Fig 12b.** Unclamped Inductive Waveforms



**Fig 13a.** Basic Gate Charge Waveform



**Fig 12c.** Maximum Avalanche Energy Vs. Drain Current



**Fig 13b.** Gate Charge Test Circuit

**Appendix A:** Figure 14, Peak Diode Recovery  $dv/dt$  Test Circuit – See page 1505

**Appendix B:** Package Outline Mechanical Drawing – See page 1511

**Appendix C:** Part Marking Information – See page 1517