

HEXFET® Power MOSFET

**Application**

- High Efficiency Synchronous Rectification in SMPS
- Uninterruptible Power Supply
- High Speed Power Switching
- Hard Switched and High Frequency Circuits

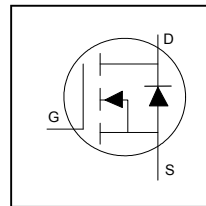

<b>V<sub>DSS</sub></b>	<b>300V</b>
<b>R<sub>DS(on)</sub> typ.</b>	<b>56mΩ</b>
	<b>69mΩ</b>
<b>I<sub>D</sub></b>	<b>38A</b>

**Benefits**

- Improved Gate, Avalanche and Dynamic dV/dt Ruggedness
- Fully Characterized Capacitance and Avalanche SOA
- Enhanced body diode dV/dt and dI/dt Capability
- Lead-Free, RoHS Compliant

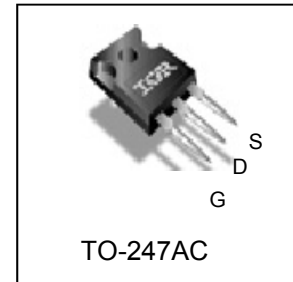

<b>G</b>	<b>D</b>	<b>S</b>
Gate	Drain	Source

Base part number	Package Type	Standard Pack		Orderable Part Number
		Form	Quantity	
IRFP4137PbF	TO-247AC	Tube	25	IRFP4137PbF

	Parameter	Max.	Units
I <sub>D</sub> @ T <sub>C</sub> = 25°C	Continuous Drain Current, V <sub>GS</sub> @ 10V	38	A
I <sub>D</sub> @ T <sub>C</sub> = 100°C	Continuous Drain Current, V <sub>GS</sub> @ 10V	27	
I <sub>DM</sub>	Pulsed Drain Current ①	152	
P <sub>D</sub> @ T <sub>C</sub> = 25°C	Maximum Power Dissipation	341	W
	Linear Derating Factor	2.3	W/°C
V <sub>GS</sub>	Gate-to-Source Voltage	± 20	V
dv/dt	Peak Diode Recovery dv/dt③	8.9	V/ns
T <sub>J</sub> T <sub>STG</sub>	Operating Junction and Storage Temperature Range	-55 to + 175	°C
	Soldering Temperature, for 10 seconds (1.6mm from case)	300	
	Mounting Torque, 6-32 or M3 Screw	10 lbf·in (1.1 N·m)	

**Avalanche Characteristics**

E <sub>AS</sub> (Thermally limited)	Single Pulse Avalanche Energy ②	541	mJ
-------------------------------------	---------------------------------	-----	----

**Thermal Resistance**

	Parameter	Typ.	Max.	Units
R <sub>θJC</sub>	Junction-to-Case ③	—	0.44	°C/W
R <sub>θCS</sub>	Case-to-Sink, Flat Greased Surface	0.24	—	
R <sub>θJA</sub>	Junction-to-Ambient ⑦⑧	—	40	

**Static @ T<sub>J</sub> = 25°C (unless otherwise specified)**

	Parameter	Min.	Typ.	Max.	Units	Conditions
V <sub>(BR)DSS</sub>	Drain-to-Source Breakdown Voltage	300	—	—	V	V <sub>GS</sub> = 0V, I <sub>D</sub> = 250μA
ΔV <sub>(BR)DSS</sub> /ΔT <sub>J</sub>	Breakdown Voltage Temp. Coefficient	—	0.24	—	V/°C	Reference to 25°C, I <sub>D</sub> = 3.5mA
R <sub>DS(on)</sub>	Static Drain-to-Source On-Resistance	—	56	69	mΩ	V <sub>GS</sub> = 10V, I <sub>D</sub> = 24A ④
V <sub>GS(th)</sub>	Gate Threshold Voltage	3.0	—	5.0	V	V <sub>DS</sub> = V <sub>GS</sub> , I <sub>D</sub> = 250μA
I <sub>DSS</sub>	Drain-to-Source Leakage Current	—	—	20	μA	V <sub>DS</sub> = 300V, V <sub>GS</sub> = 0V
		—	—	250		V <sub>DS</sub> = 300V, V <sub>GS</sub> = 0V, T <sub>J</sub> = 125°C
I <sub>GSS</sub>	Gate-to-Source Forward Leakage	—	—	100	nA	V <sub>GS</sub> = 20V
	Gate-to-Source Reverse Leakage	—	—	-100		V <sub>GS</sub> = -20V
R <sub>G</sub>	Gate Resistance	—	1.3	—	Ω	

**Dynamic Electrical Characteristics @ T<sub>J</sub> = 25°C (unless otherwise specified)**

g <sub>fs</sub>	Forward Transconductance	45	—	—	S	V <sub>DS</sub> = 50V, I <sub>D</sub> = 24A
Q <sub>g</sub>	Total Gate Charge	—	83	125	nC	I <sub>D</sub> = 24A
Q <sub>gs</sub>	Gate-to-Source Charge	—	28	42		V <sub>DS</sub> = 150V
Q <sub>gd</sub>	Gate-to-Drain Charge	—	26	39		V <sub>GS</sub> = 10V
t <sub>d(on)</sub>	Turn-On Delay Time	—	18	—	ns	V <sub>DD</sub> = 195V
t <sub>r</sub>	Rise Time	—	23	—		I <sub>D</sub> = 24A
t <sub>d(off)</sub>	Turn-Off Delay Time	—	34	—		R <sub>G</sub> = 2.2Ω
t <sub>f</sub>	Fall Time	—	20	—		V <sub>GS</sub> = 10V
C <sub>iss</sub>	Input Capacitance	—	5168	—	pF	V <sub>GS</sub> = 0V
C <sub>oss</sub>	Output Capacitance	—	300	—		V <sub>DS</sub> = 50V
C <sub>rss</sub>	Reverse Transfer Capacitance	—	77	—		f = 1.0MHz
C <sub>oss eff.(ER)</sub>	Effective Output Capacitance (Energy Related)	—	196	—		V <sub>GS</sub> = 0V, V <sub>DS</sub> = 0V to 240V <sup>⑥</sup>
C <sub>oss eff.(TR)</sub>	Output Capacitance (Time Related)	—	265	—		See Fig.11
						V <sub>GS</sub> = 0V, V <sub>DS</sub> = 0V to 240V <sup>⑤</sup>

**Diode Characteristics**

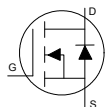
	Parameter	Min.	Typ.	Max.	Units	Conditions
I <sub>S</sub>	Continuous Source Current (Body Diode) ①	—	—	40	A	MOSFET symbol showing the integral reverse p-n junction diode. 
I <sub>SM</sub>	Pulsed Source Current (Body Diode) ①	—	—	160		
V <sub>SD</sub>	Diode Forward Voltage	—	—	1.3	V	T <sub>J</sub> = 25°C, I <sub>S</sub> = 24A, V <sub>GS</sub> = 0V ④
t <sub>rr</sub>	Reverse Recovery Time	—	302	—	ns	T <sub>J</sub> = 25°C V <sub>DD</sub> = 255V
		—	379	—		T <sub>J</sub> = 125°C I <sub>F</sub> = 24A,
Q <sub>rr</sub>	Reverse Recovery Charge	—	1739	—	nC	T <sub>J</sub> = 25°C di/dt = 100A/μs ④
		—	2497	—		T <sub>J</sub> = 125°C
I <sub>RSM</sub>	Reverse Recovery Current	—	13	—	A	T <sub>J</sub> = 25°C

**Notes:**

- ① Repetitive rating; pulse width limited by max. junction temperature.
- ② Recommended max EAS limit, starting T<sub>J</sub> = 25°C, L = 2.05mH, R<sub>G</sub> = 50Ω, I<sub>AS</sub> = 24A, V<sub>GS</sub> = 10V.
- ③ I<sub>SD</sub> ≤ 24A, di/dt ≤ 1771A/μs, V<sub>DD</sub> ≤ V<sub>(BR)DSS</sub>, T<sub>J</sub> ≤ 175°C.
- ④ Pulse width ≤ 400μs; duty cycle ≤ 2%.
- ⑤ C<sub>oss eff. (TR)</sub> is a fixed capacitance that gives the same charging time as C<sub>oss</sub> while V<sub>DS</sub> is rising from 0 to 80% V<sub>DSS</sub>.
- ⑥ C<sub>oss eff. (ER)</sub> is a fixed capacitance that gives the same energy as C<sub>oss</sub> while V<sub>DS</sub> is rising from 0 to 80% V<sub>DSS</sub>.
- ⑦ When mounted on 1" square PCB (FR-4 or G-10 Material). For recommended footprint and soldering techniques refer to application note #AN-994
- ⑧ R<sub>θ</sub> is measured at T<sub>J</sub> approximately 90°C

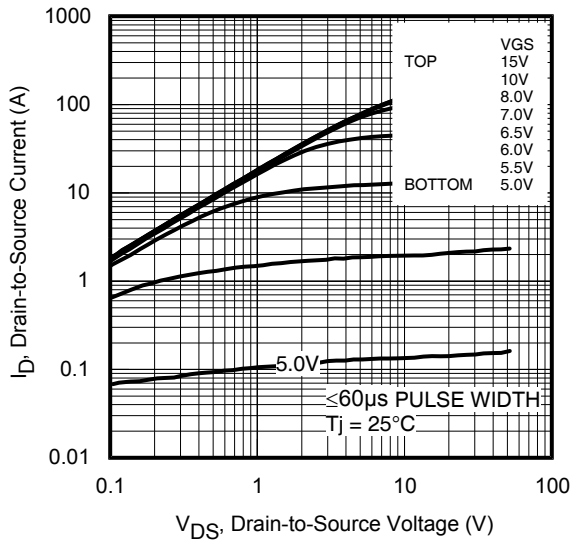
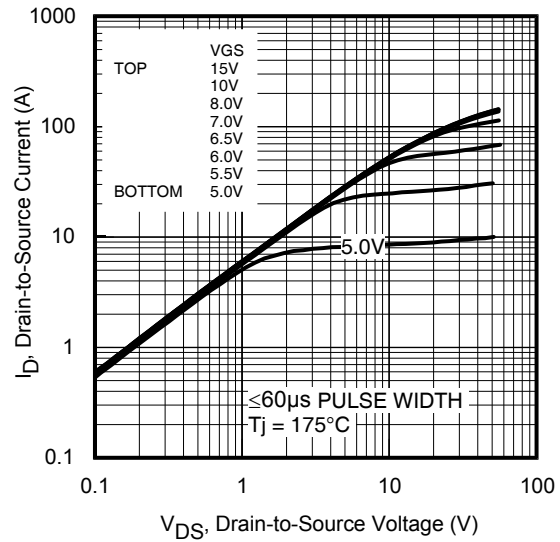
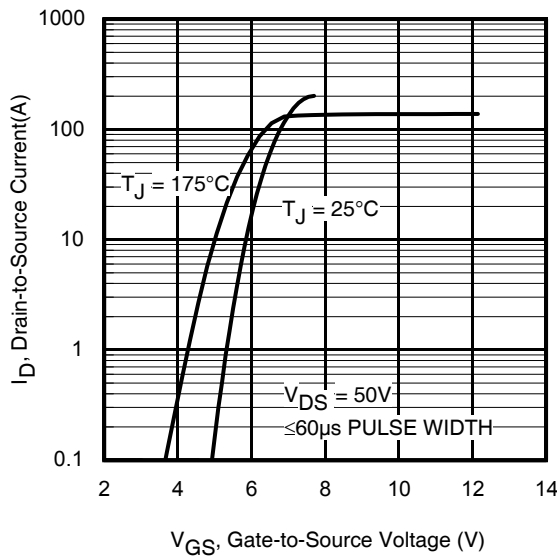
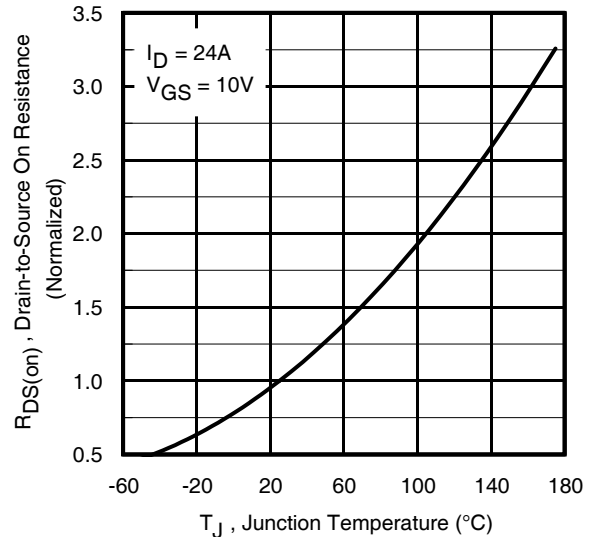
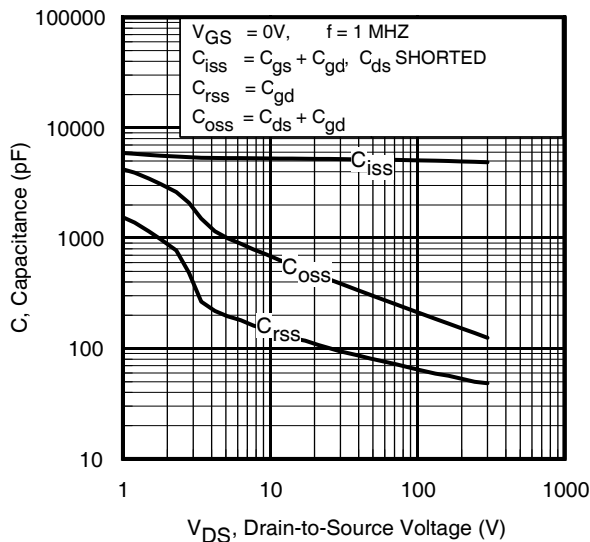
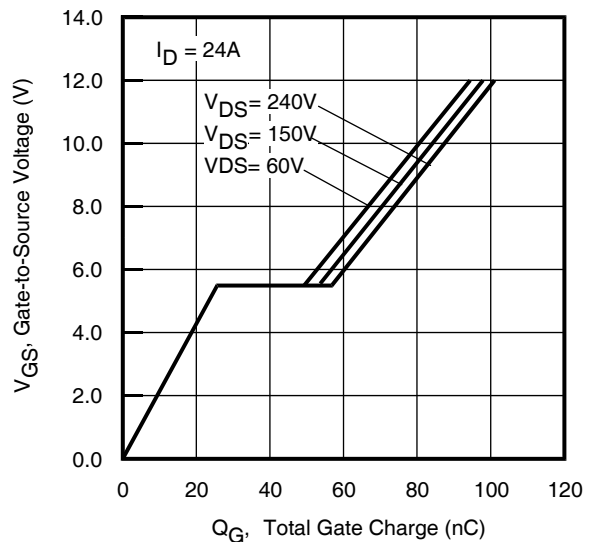
**Fig 1. Typical Output Characteristics**

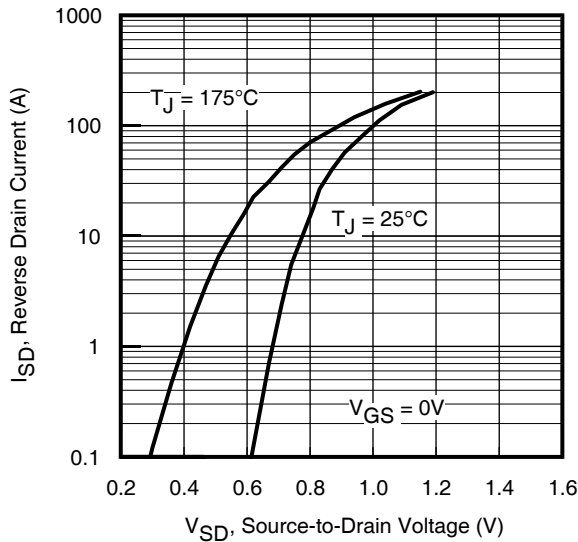
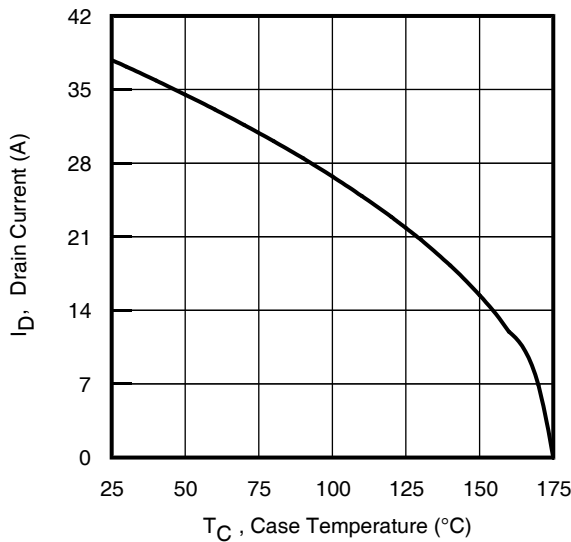
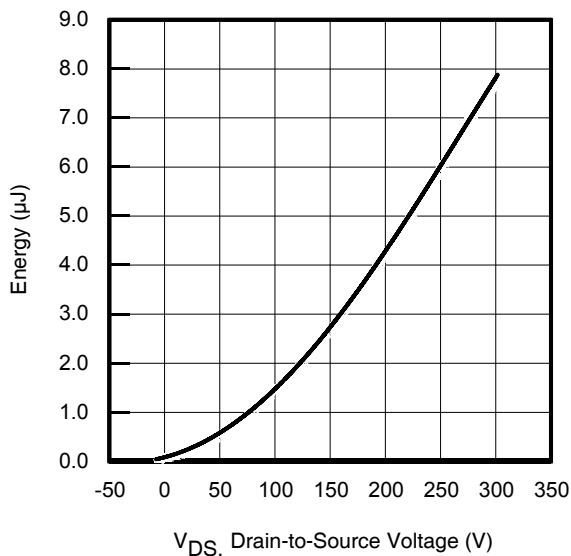
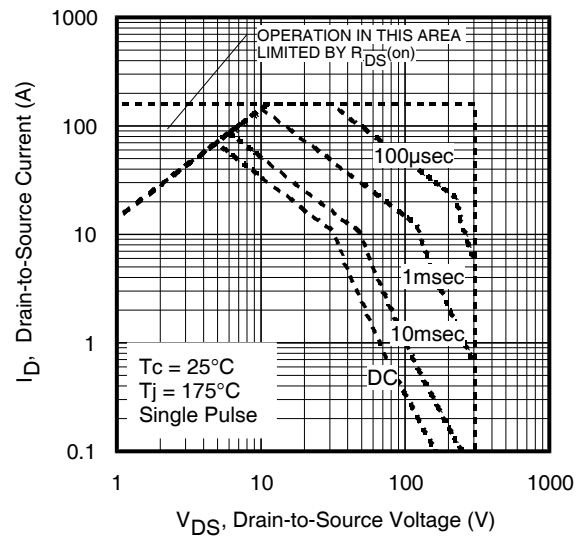
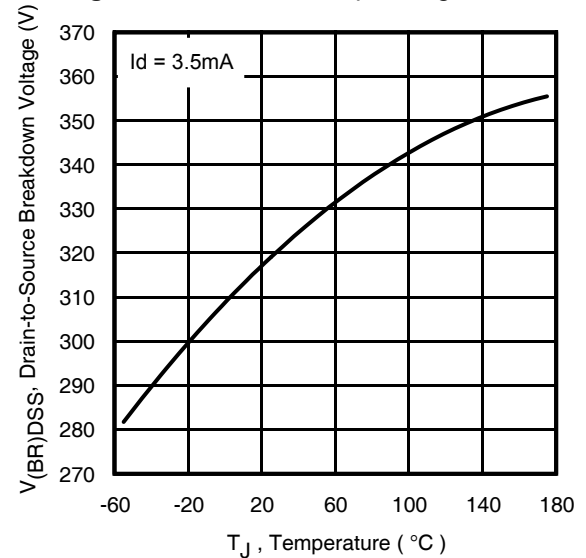
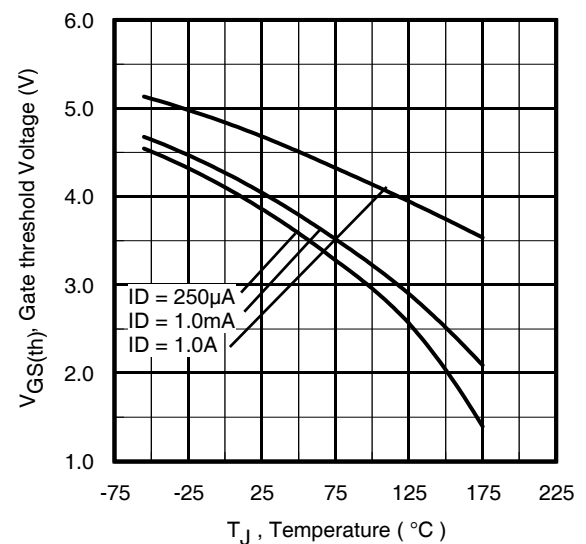
**Fig 2. Typical Output Characteristics**

**Fig 3. Typical Transfer Characteristics**

**Fig 4. Normalized On-Resistance vs. Temperature**

**Fig 5. Typical Capacitance vs. Drain-to-Source Voltage**

**Fig 6. Typical Gate Charge vs. Gate-to-Source Voltage**

**Fig 7. Typical Source-Drain Diode Forward Voltage**

**Fig 9. Maximum Drain Current vs. Case Temperature**

**Fig 11. Typical  $C_{oss}$  Stored Energy**

**Fig 8. Maximum Safe Operating Area**

**Fig 10. Drain-to-Source Breakdown Voltage**

**Fig 12. Threshold Voltage vs. Temperature**

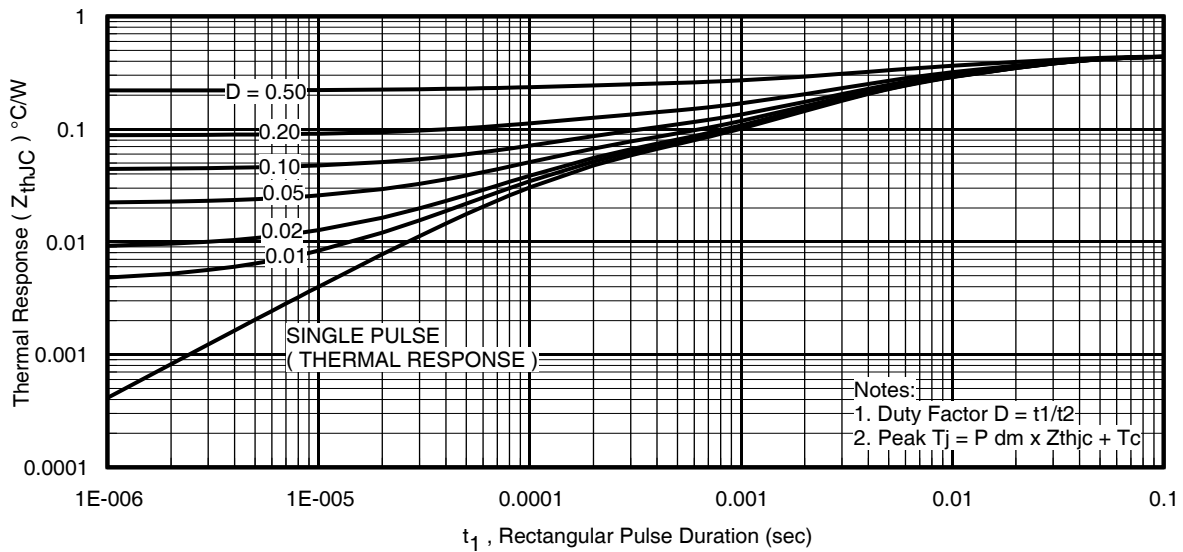

Fig 13. Maximum Effective Transient Thermal Impedance, Junction-to-Case

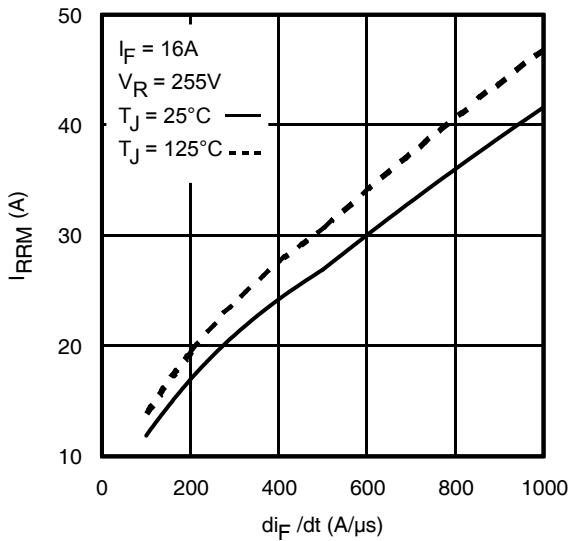

Fig 14. Typical Recovery Current vs. dif/dt

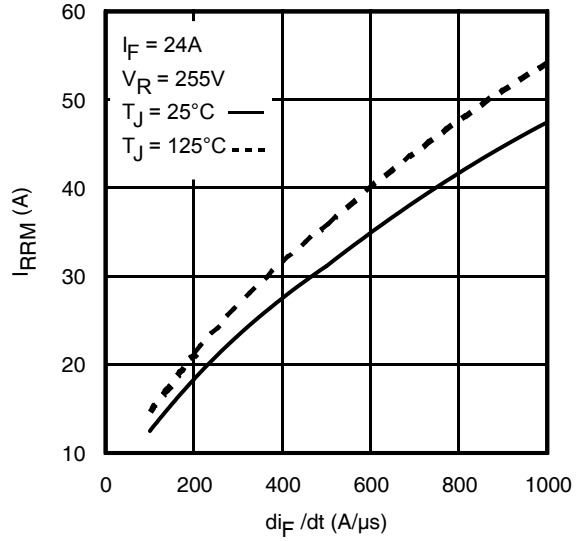

Fig 15. Typical Recovery Current vs. dif/dt

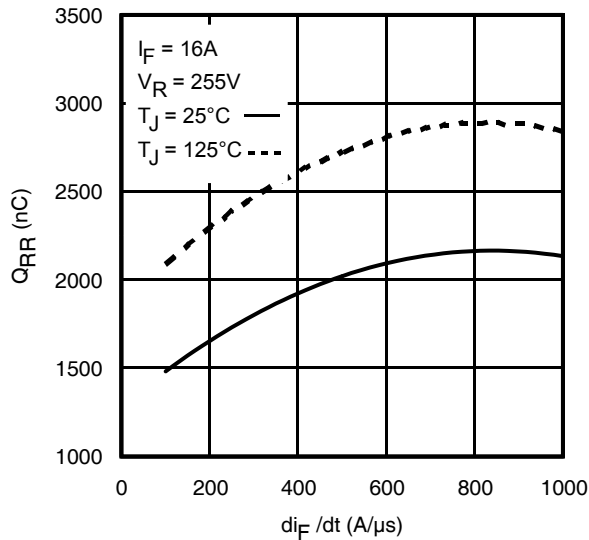

Fig 16. Typical Stored Charge vs. dif/dt

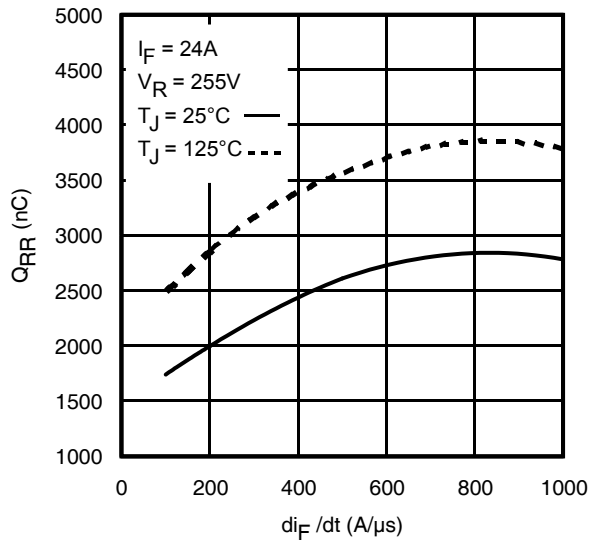
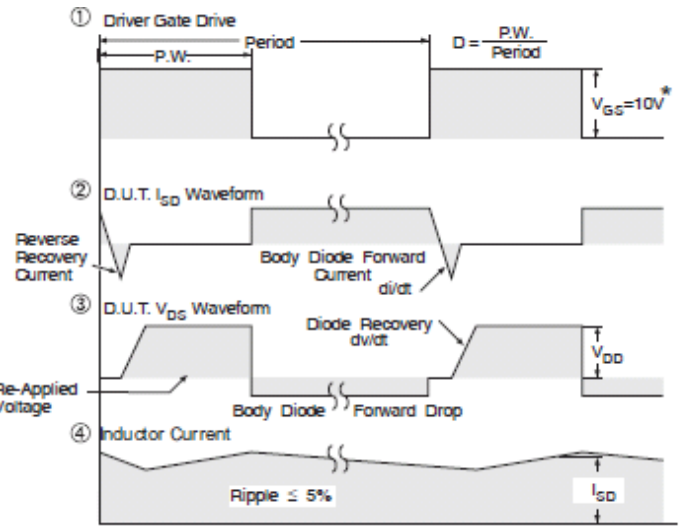
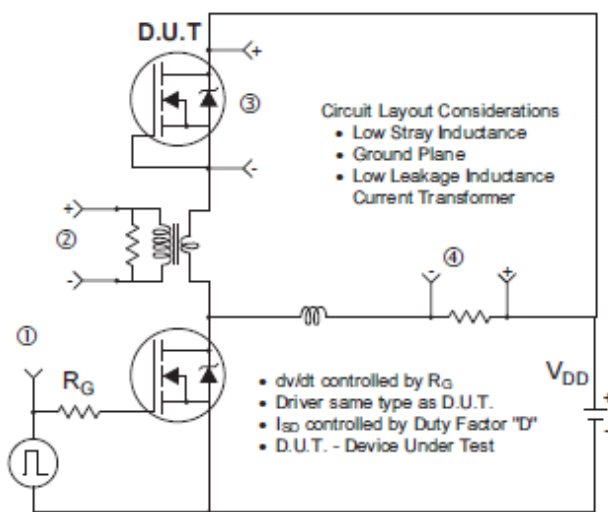
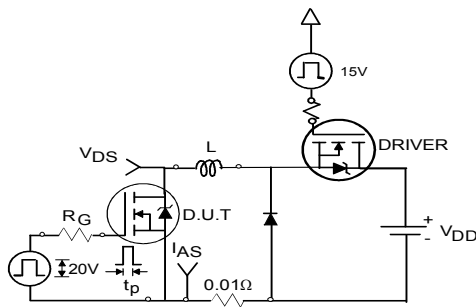

Fig 17. Typical Stored Charge vs. dif/dt



\*  $V_{GS} = 5V$  for Logic Level Devices

**Fig 18.** Peak Diode Recovery  $dv/dt$  Test Circuit for N-Channel HEXFET® Power MOSFETs



**Fig 19a.** Unclamped Inductive Test Circuit

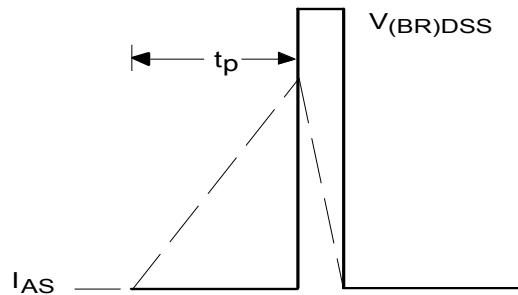

**Fig 19b.** Unclamped Inductive Waveforms

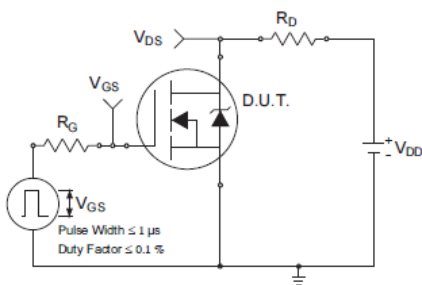

**Fig 20a.** Switching Time Test Circuit

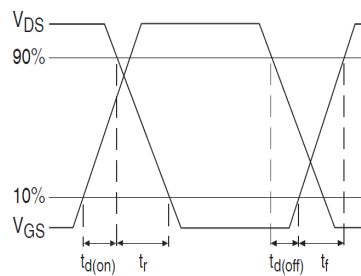

**Fig 20b.** Switching Time Waveforms

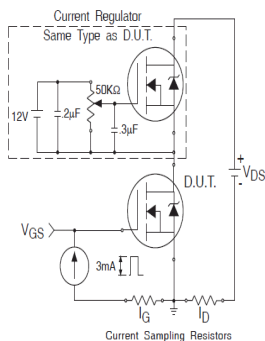

**Fig 21a.** Gate Charge Test Circuit

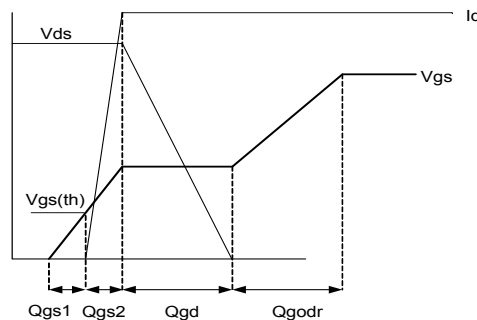

**Fig 21b.** Gate Charge Waveform

## TO-247AC Package Outline

Dimensions are shown in millimeters (inches)

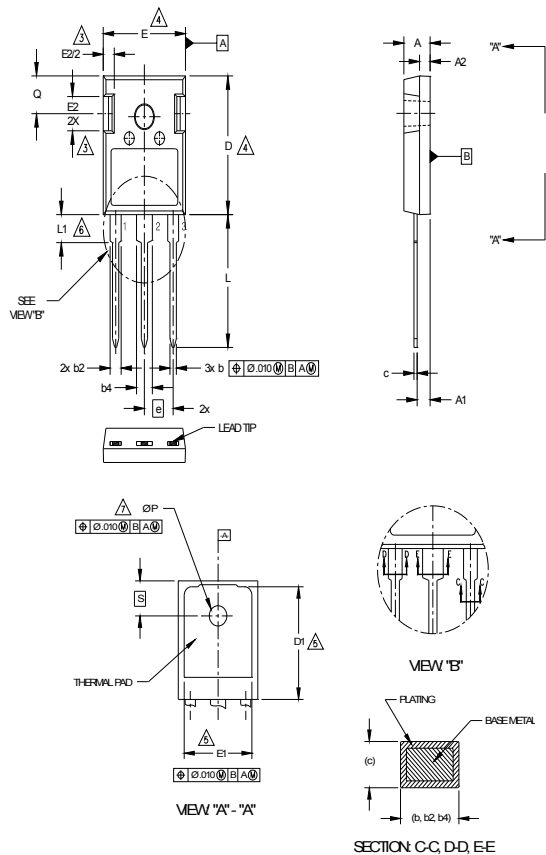

SYMBOL	DIMENSIONS				NOTES
	INCHES		MILLIMETERS		
	MIN.	MAX.	MIN.	MAX.	
A	.190	.204	4.83	5.20	
A1	.090	.100	2.29	2.54	
A2	.075	.085	1.91	2.16	
b	.042	.052	1.07	1.33	
b2	.075	.094	1.91	2.41	
b4	.113	.133	2.87	3.38	
c	.022	.026	0.55	0.68	
D	.819	.830	20.80	21.10	4
D1	.640	.694	16.25	17.65	5
E	.620	.635	15.75	16.13	4
E1	.512	.570	13.00	14.50	
E2	.145	.196	3.68	5.00	
e	.215 Typical		5.45 Typical		
L	.780	.800	19.80	20.32	
L1	.161	.173	4.10	4.40	
Ø P	.138	.143	3.51	3.65	
Q	.216	.236	5.49	6.00	
S	.238	.248	6.04	6.30	

- LEAD ASSIGNMENTS**
- HEXFET**
- 1.- GATE
  - 2.- DRAIN
  - 3.- SOURCE
  - 4.- DRAIN
- IGBTs, CoPACK**
- 1.- GATE
  - 2.- COLLECTOR
  - 3.- EMITTER
  - 4.- COLLECTOR
- DIODES**
- 1.- ANODE/OPEN
  - 2.- CATHODE
  - 3.- ANODE

- NOTES:**
- 1 DIMENSIONING AND TOLERANCING AS PER ASME Y14.5M 1994.
  - 2 DIMENSIONS ARE SHOWN IN INCHES AND MILLIMETERS.
  - 3 CONTOUR OF SLOT OPTIONAL.
  - 4 DIMENSION D & E DO NOT INCLUDE MOLD FLASH. MOLD FLASH SHALL NOT EXCEED .005" (0.127) PER SIDE. THESE DIMENSIONS ARE MEASURED AT THE OUTERMOST EXTREMES OF THE PLASTIC BODY.
  - 5 THERMAL PAD CONTOUR OPTIONAL WITHIN DIMENSIONS D1 & E1.
  - 6 LEAD FINISH UNCONTROLLED IN L1.
  - 7 Ø P TO HAVE A MAXIMUM DRAFT ANGLE OF 1.5 ° TO THE TOP OF THE PART WITH A MAXIMUM HOLE DIAMETER OF .154 INCH.

## TO-247AC Part Marking Information

Notes: This part marking information applies to devices produced after 02/26/2001

EXAMPLE: THIS IS AN IRFPE30  
WITH ASSEMBLY  
LOT CODE 5657  
ASSEMBLED ON WW 35, 2001  
IN THE ASSEMBLY LINE "H"

Note: "P" in assembly line position  
indicates "Lead-Free"

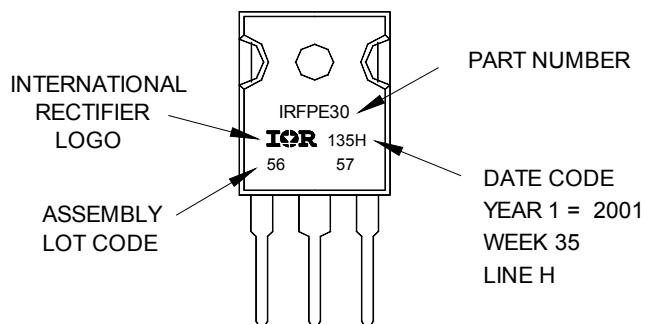

TO-247AC package is not recommended for Surface Mount Application.

Note: For the most current drawing please refer to IR website at <http://www.irf.com/package/>

**Qualification Information†**

<b>Qualification Level</b>	Industrial (per JEDEC JESD47F) ††	
<b>Moisture Sensitivity Level</b>	TO-247AC	N/A
<b>RoHS Compliant</b>	Yes	

† Qualification standards can be found at International Rectifier’s web site: <http://www.irf.com/product-info/reliability/>

†† Applicable version of JEDEC standard at the time of product release.

Data and specifications subject to change without notice.



**IR WORLD HEADQUARTERS:** 101N Sepulveda., El Segundo, California 90245, USA Tel: (310) 252-7105

TAC Fax: (310) 252-7903

Visit us at [www.irf.com](http://www.irf.com) for sales contact information.



# Mouser Electronics

Authorized Distributor

Click to View Pricing, Inventory, Delivery & Lifecycle Information:

[International Rectifier:](#)

[IRFP4137PBF](#)