

IRS21850S SINGLE HIGH SIDE DRIVER IC

IC Features

- Gate drive supply range from 10 V to 20 V
- Undervoltage lockout for V_{BS} and V_{CC}
- 3.3 V and 5 V input logic compatible
- Tolerant to negative transient voltage
- Matched propagation delays for all channels
- RoHS compliant

Product Summary

Topology	Single High Side
V_{OFFSET}	600 V
V_{OUT}	10V - 20V
I_{O+} & I_{O-} (typical)	4A / 4A
t_{on} & t_{off} (typical)	160ns & 160ns

Package Types

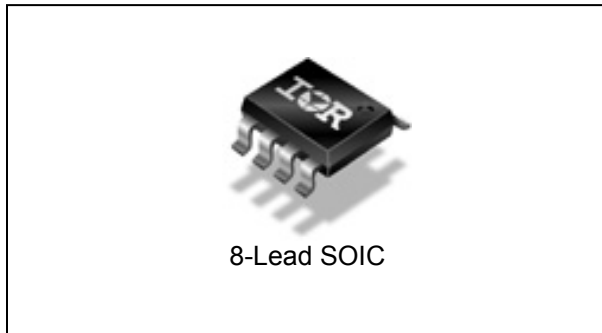

Typical Connection Diagram

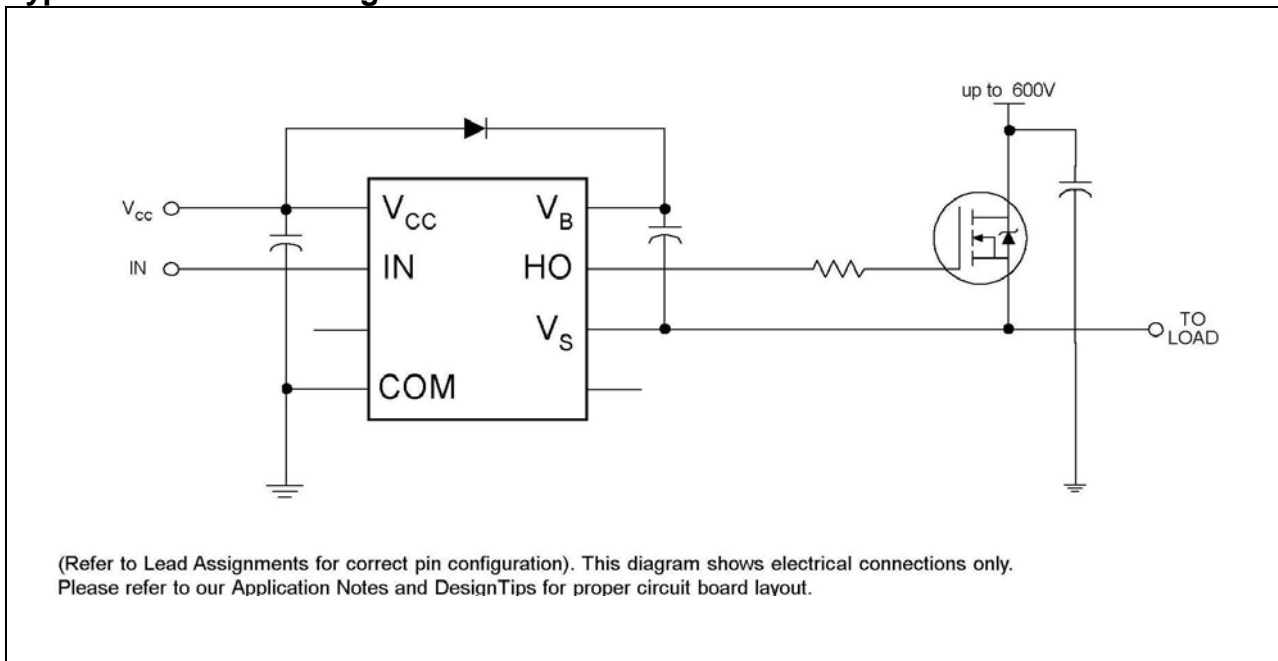

Table of Contents	Page
Description	3
Qualification Information	4
Absolute Maximum Ratings	5
Recommended Operating Conditions	5
Dynamic Electrical Characteristics	6
Static Electrical Characteristics	6
Functional Block Diagram	7
Input/Output Pin Equivalent Circuit Diagram	8
Lead Definitions	9
Lead Assignments	9
Waveform Definitions	10
Parameter Temperature Trends	11
Package Details	17
Tape and Reel Details	18
Part Marking Information	19
Ordering Information	20

Description

The IRS21850 is a high voltage, high speed power MOSFET and IGBT single high-side driver with propagation delay matched output channels. Proprietary HVIC and latch immune CMOS technologies enable ruggedized monolithic construction. The floating logic input is compatible with standard CMOS or LSTTL output, down to 3.3V logic and can be operated up to 600 V above the ground. The output driver features a high pulse current buffer stage designed for minimum driver cross-conduction. The floating channel can be used to drive an N-channel power MOSFET or IGBT in the high-side configuration, which operates up to 600 V.

Qualification Information[†]

Qualification Level		Industrial ^{††}	
		Comments: This family of ICs has passed JEDEC's Industrial qualification. IR's Consumer qualification level is granted by extension of the higher Industrial level.	
Moisture Sensitivity Level		SOIC8	MSL2 ^{†††} 260°C (per IPC/JEDEC J-STD-020)
ESD	Machine Model	Class C (per JEDEC standard EIA/JESD22-A115)	
	Human Body Model	Class 2 (per EIA/JEDEC standard JESD22-A114)	
IC Latch-Up Test		Class I, Level A (per JESD78)	
RoHS Compliant		Yes	

† Qualification standards can be found at International Rectifier's web site <http://www.irf.com/>

†† Higher qualification ratings may be available should the user have such requirements. Please contact your International Rectifier sales representative for further information.

††† Higher MSL ratings may be available for the specific package types listed here. Please contact your International Rectifier sales representative for further information.

Absolute Maximum Ratings

Absolute maximum ratings indicate sustained limits beyond which damage to the device may occur. All voltage parameters are absolute voltages referenced to COM. The thermal resistance and power dissipation ratings are measured under boardmounted and still air conditions.

Symbol	Definition	Min.	Max.	Units
V _{CC}	Low-side supply voltage	-0.3	20 [†]	V
V _{IN}	Low-side output voltage (HIN)	COM -0.3	V _{CC} + 0.3	
V _B	High-side floating well supply voltage	-0.3	620 [†]	
V _S	High-side floating well supply return voltage	V _B -20	V _B + 0.3	
V _{HO}	Floating gate drive output voltage	V _S -0.3	V _B + 0.3	
dV _S /dt	Allowable VS offset supply transient relative to COM	---	50	V/ns
P _D	Maximum Power Dissipation @ TA ≤ +25°C	---	1.25	W
Rth _{JA}	Thermal resistance, junction to ambient	---	100	°C/W
T _J	Junction temperature	-55	150	°C
T _S	Storage temperature	-55	150	
T _L	Lead temperature (soldering, 10 seconds)	---	300	

† All supplies are fully tested at 25 V. An internal 20 V clamp exists for each supply.

Recommended Operating Conditions

For proper operation, the device should be used within the recommended conditions. All voltage parameters are absolute voltages referenced to COM. The offset rating are tested with supplies of (V_{CC}-COM)= (V_B-V_S)=15 V.

Symbol	Definition	Min.	Max.	Units
V _{CC}	Low-side supply voltage	10	20	V
V _{IN}	HIN input voltage	COM	V _{CC}	
V _B	High-side floating well supply voltage	V _S + 10	V _S + 20	
V _S	High-side floating well supply offset voltage	Note 2	600	
V _{HO}	Floating gate drive output voltage	V _S	V _B	
T _A	Ambient temperature	-40	125	°C

†† Logic operational for VS of -5 V to +600 V. Logic state held for V_S of -5 V to -V_{BS}. (Please refer to the Design Tip DT97-3 for more details).

Dynamic Electrical Characteristics

(V_{CC-COM})= (V_B-V_S) =15 V, $T_A = 25\text{ }^\circ\text{C}$. $C_L = 1000\text{ pF}$ unless otherwise specified. All parameters are referenced to COM.

Symbol	Definition	Min	Typ	Max	Units	Test Conditions
t_{on}	Turn-on propagation delay	---	160	210	ns	(V_S-COM)= 0 V
t_{off}	Turn-off propagation delay	---	160	210		(V_S-COM)= 600 V
t_r	Turn-on rise time	---	15	40		
t_f	Turn-off fall time	---	15	40		

Static Electrical Characteristics

(V_{CC-COM})= (V_B-V_S) =15 V. The V_{IN} , V_{TH} , and I_{IN} parameters are referenced to COM. The V_O and I_O parameters are referenced respective V_S and are applicable to the respective output leads HO. The V_{CC} parameters are referenced to COM. The V_{BSUV} parameters are referenced to V_S .

Symbol	Definition	Min	Typ	Max	Units	Test Conditions
V_{CCUV+}	V_{CC} supply undervoltage positive going threshold	8.0	8.9	9.8	V	
V_{CCUV-}	V_{CC} supply undervoltage negative going threshold	7.4	8.2	9.0		
V_{BSUV+}	V_{BS} supply undervoltage positive going threshold	8.0	8.9	9.8		
V_{BSUV-}	V_{BS} supply undervoltage negative going threshold	7.4	8.2	9.0		
I_{LK}	High-side floating well offset supply leakage current	—	—	50	μA	$V_B = V_S = 600\text{ V}$
I_{QBS}	Quiescent V_{BS} supply current	—	80	150		$HIN = 0\text{ V or }5\text{ V}$
I_{QCC}	Quiescent V_{CC} supply current	—	120	240		
V_{IH}	Logic "1" input voltage	2.5	—	—	V	
V_{IL}	Logic "0" input voltage	—	—	0.8		
$V_{OH, HO}$	HO high level output voltage, $V_{BIAS} - V_O$	—	20	60	mV	$I_O = 2\text{ mA}$
$V_{OL, HO}$	HO low level output voltage, V_O	—	10	30		
I_{IN+}	Logic "1" input bias current	—	10	20	μA	$V_{HIN} = 5\text{ V}$
I_{IN-}	Logic "0" input bias current	—	0	5		$V_{HIN} = 0\text{ V}$
$I_{O+, HO}$	Output high short circuit pulsed current HO	—	4	—	A	$V_O = 0\text{ V}, V_{IN} = 0\text{ V}$ $PW \leq 10\text{ }\mu\text{s}$
$I_{O-, HO}$	Output low short circuit pulsed current HO	—	4	—		$V_O = 15\text{ V}, V_{IN} = 15\text{ V}$ $PW \leq 10\text{ }\mu\text{s}$

Functional Block Diagram

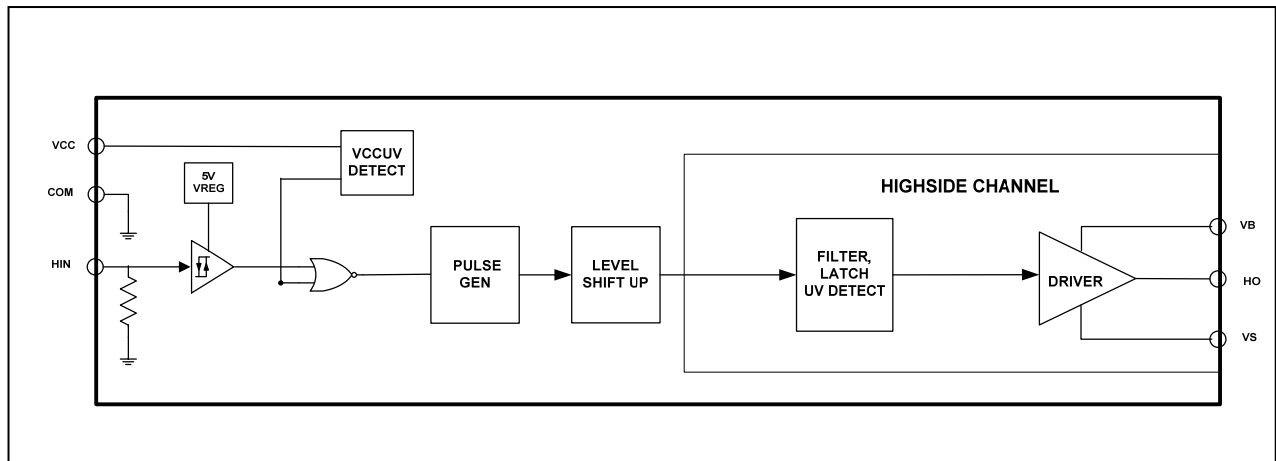

I/O Pin Equivalent Circuit Diagrams

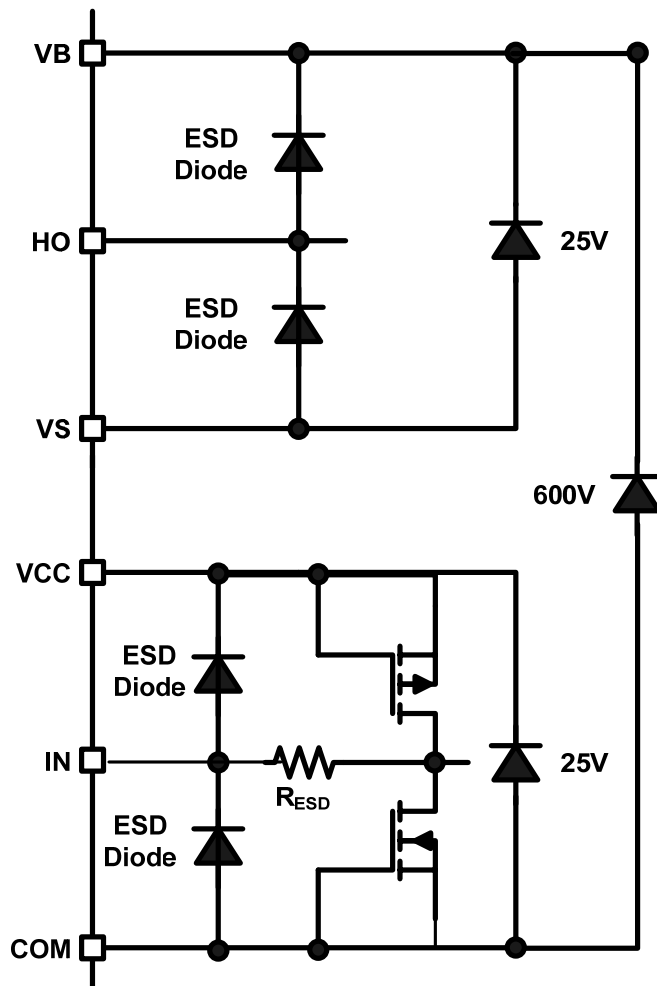

Lead Definitions

Pin #	Symbol	Description
1	VCC	Low-side supply voltage
2	HIN	Logic inputs for high-side gate driver output (in phase)
3	NC	No Connect
4	COM	Ground
5	NC	No Connect
6	VS	High voltage floating supply return
7	HO	High-side driver outputs
8	VB	High-side drive floating supply

Lead Assignments

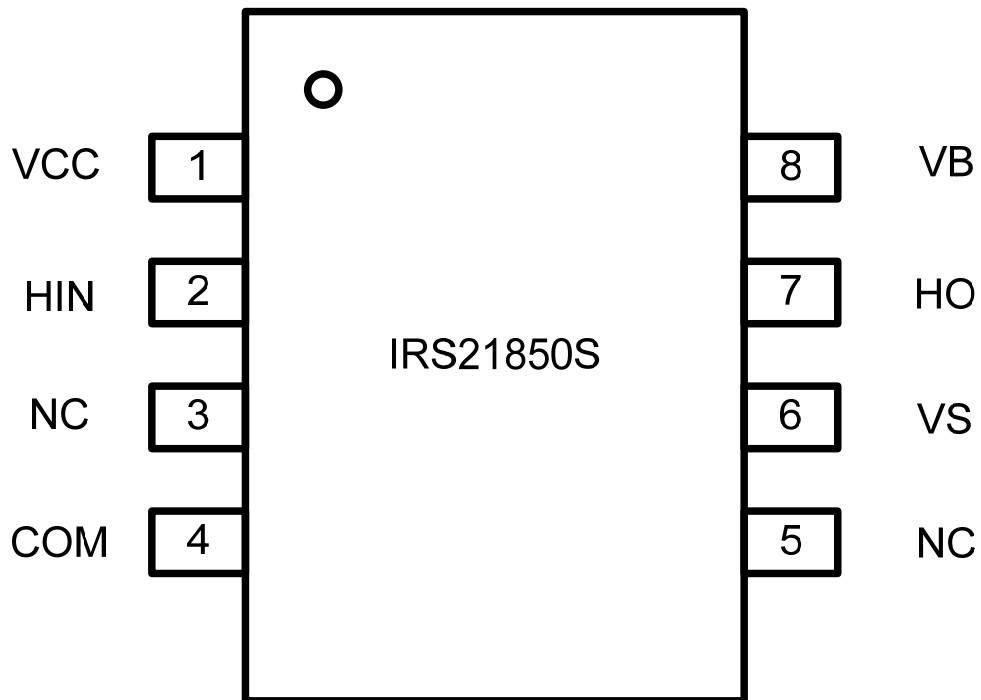

Waveform definitions

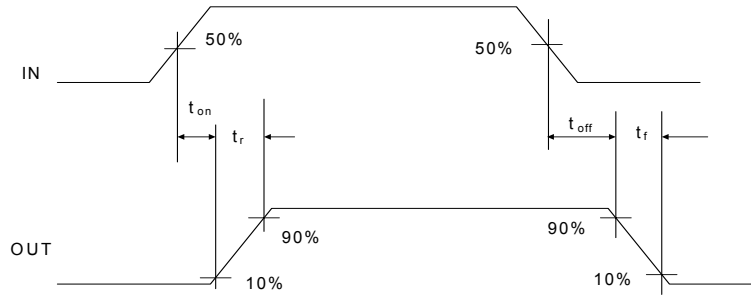

Figure 1 Switching Time Waveforms

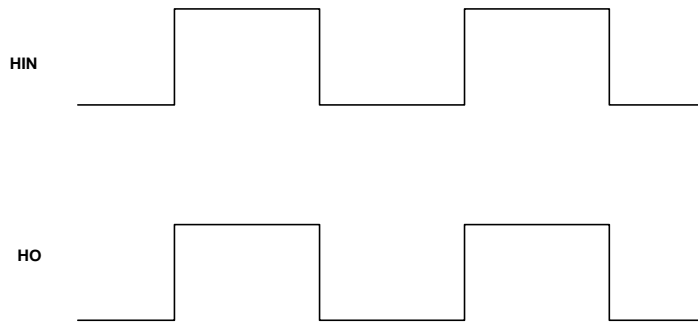

Figure 2 Input/Output Timing Diagram

Parameter Temperature Trends

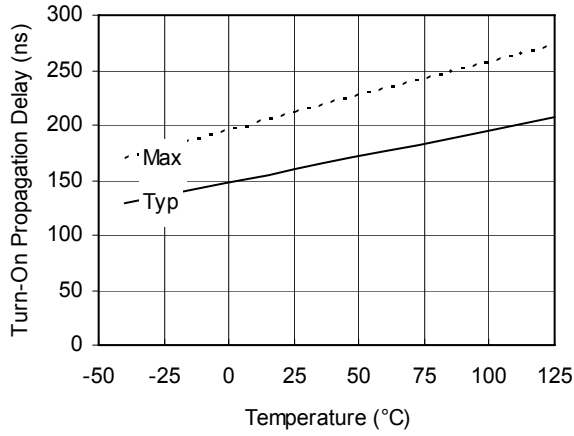

Figure 3A. Turn-On Propagation Delay vs. Temperature

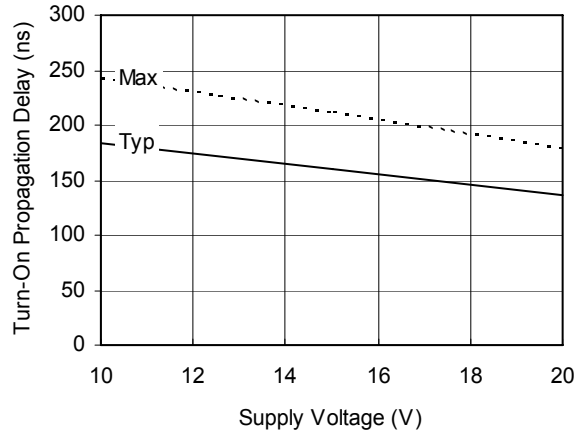

Figure 3B. Turn-On Propagation Delay vs. Supply Voltage

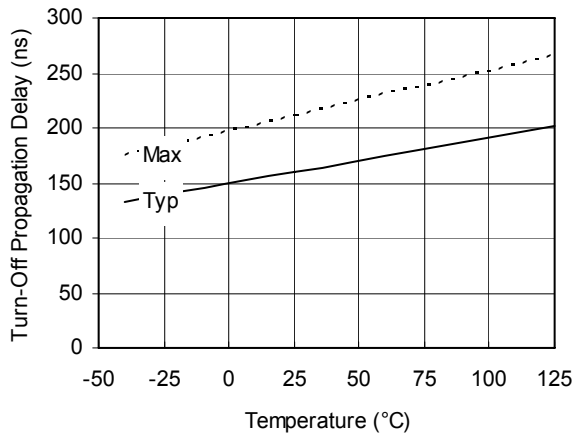

Figure 4A. Turn-Off Propagation Delay vs. Temperature

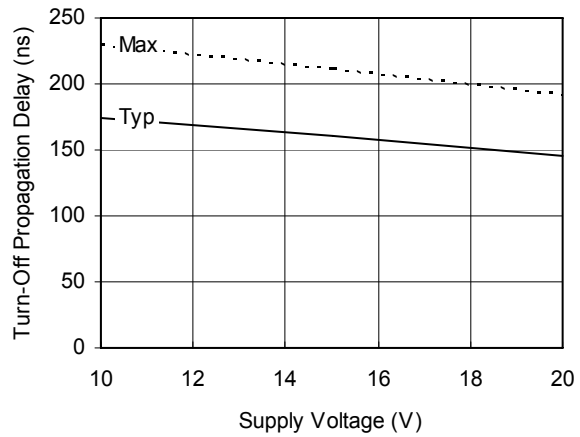

Figure 4B. Turn-Off Propagation Delay vs. Supply Voltage

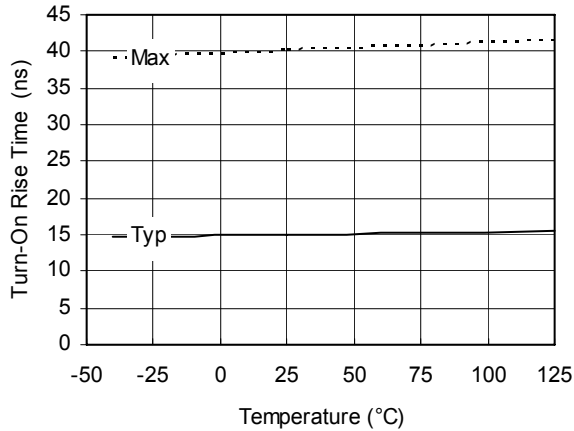

Figure 5A. Turn-On Rise Time vs. Temperature

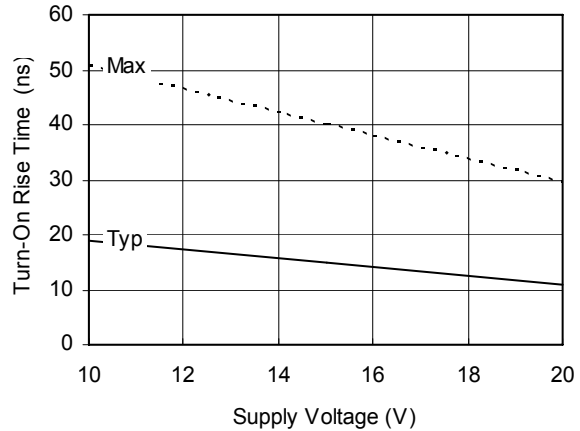

Figure 5B. Turn-On Rise Time vs. Supply Voltage

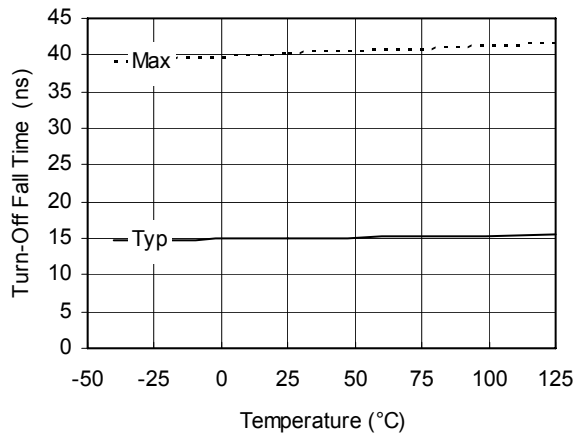

Figure 6A. Turn-Off Fall Time vs. Temperature

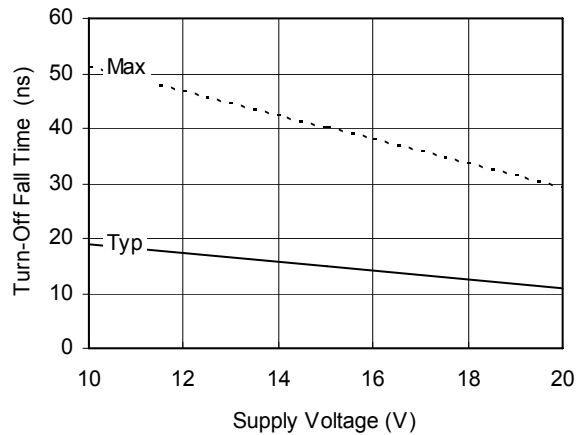

Figure 6B. Turn-Off Fall Time vs. Supply Voltage

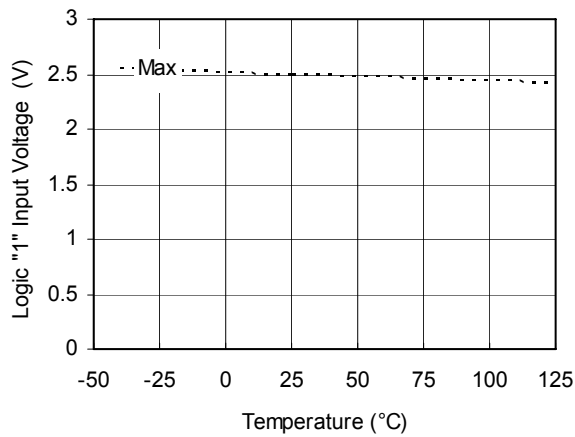

Figure 7A. Logic "1" Input Voltage vs. Temperature

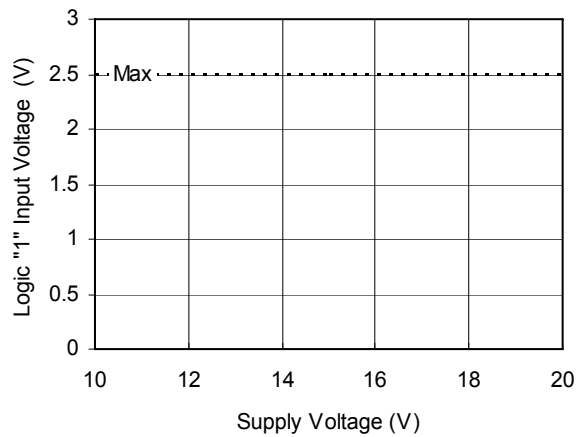

Figure 7B. Logic "1" Input Voltage vs. Supply Voltage

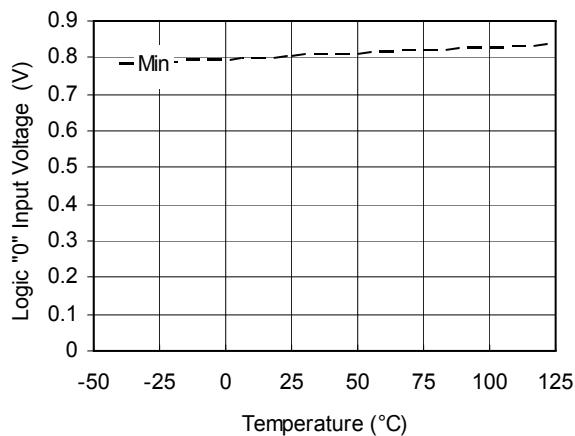

Figure 8A. Logic "0" Input Voltage vs. Temperature

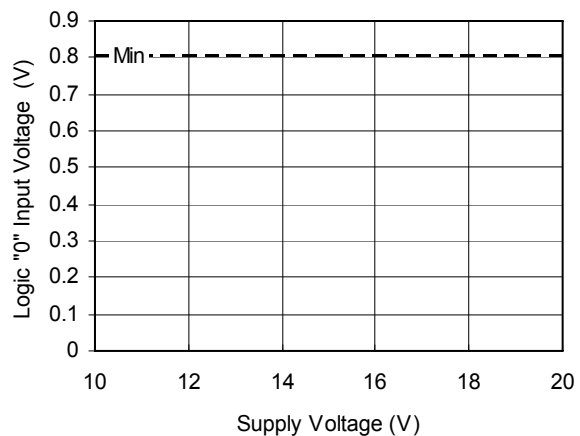

Figure 8B. Logic "0" Input Voltage vs. Supply Voltage

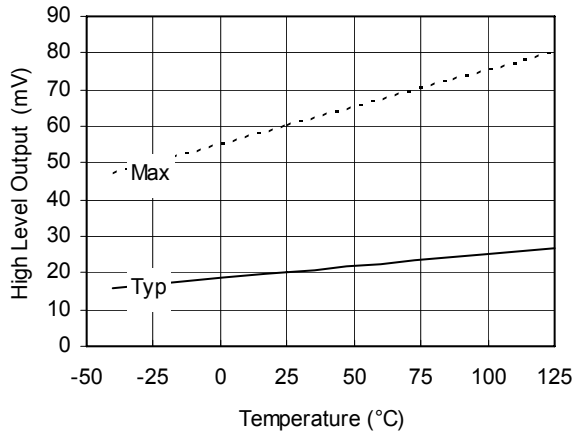

Figure 9A. High Level Output vs. Temperature (Io = 2mA)

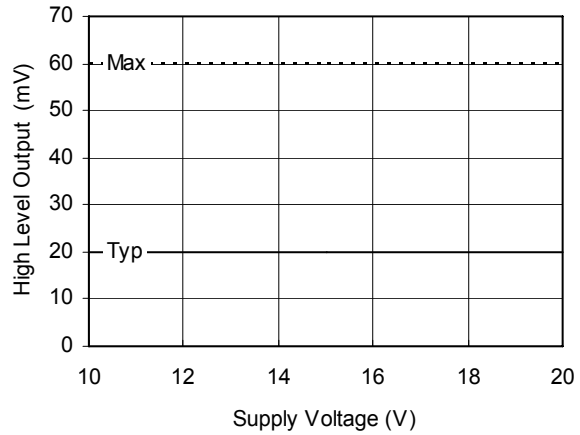

Figure 9B. High Level Output vs. Supply Voltage (Io = 2mA)

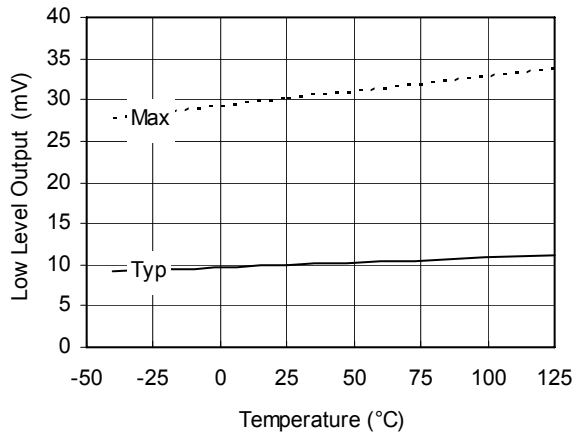

Figure 10A. Low Level Output vs. Temperature (Io = 2mA)

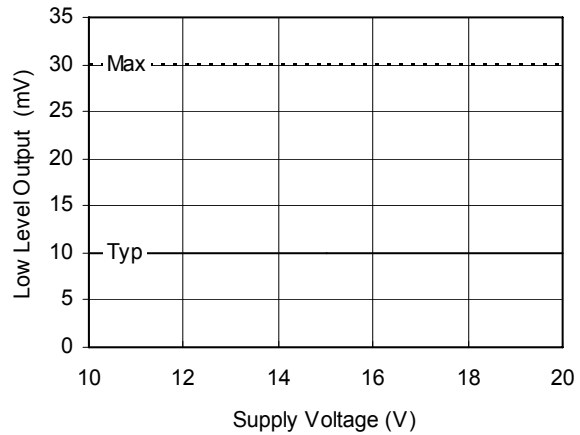

Figure 10B. Low Level Output vs. Supply Voltage (Io = 2mA)

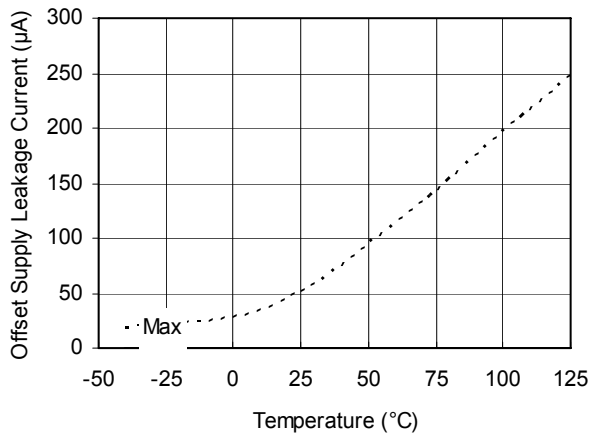

Figure 11A. Offset Supply Leakage Current vs. Temperature

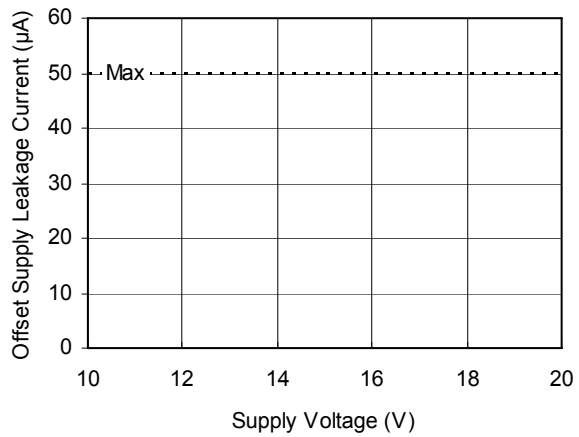

Figure 11B. Offset Supply Leakage Current vs. Supply Voltage

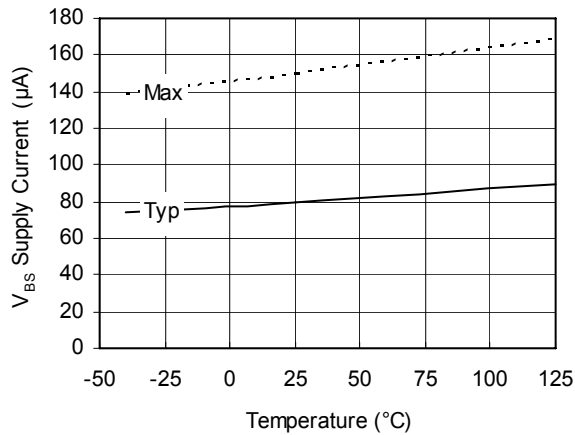

Figure 12A. V_{BS} Supply Current vs. Temperature

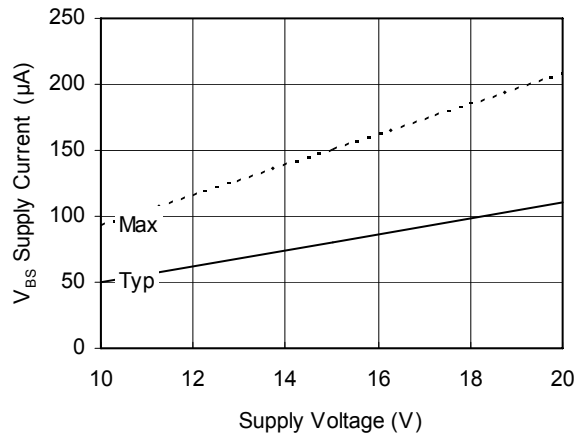

Figure 12B. V_{BS} Supply Current vs. Supply Voltage

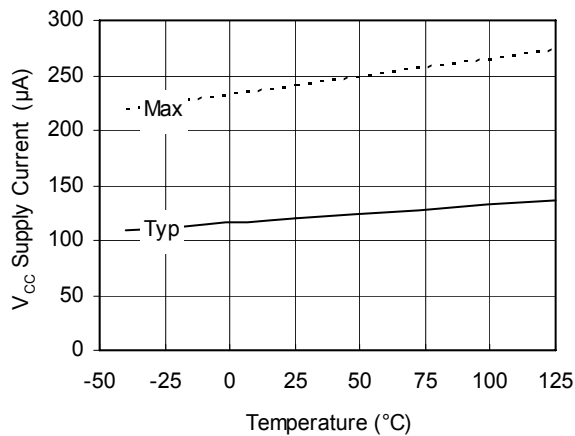

Figure 13A. V_{CC} Supply Current vs. Temperature

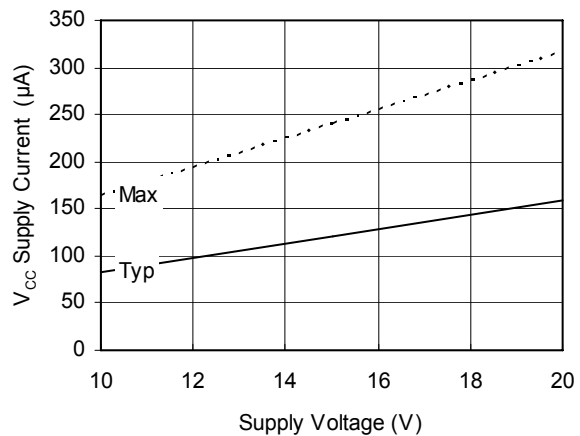

Figure 13B. V_{CC} Supply Current vs. Supply Voltage

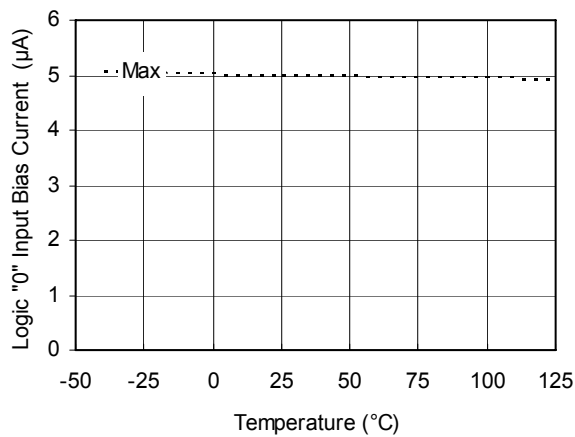

Figure 14A. Logic "0" Input Bias Current vs. Temperature

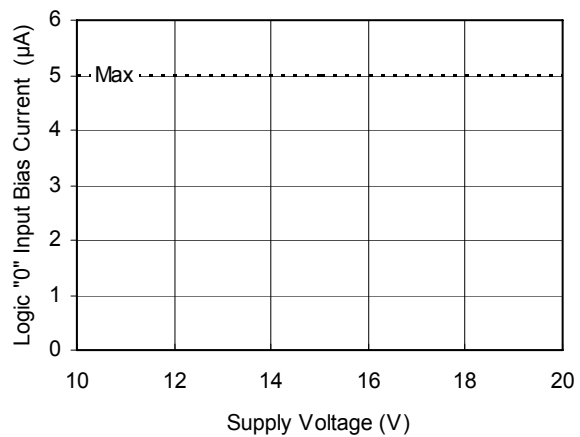

Figure 14B. Logic "0" Input Bias Current vs. Supply Voltage

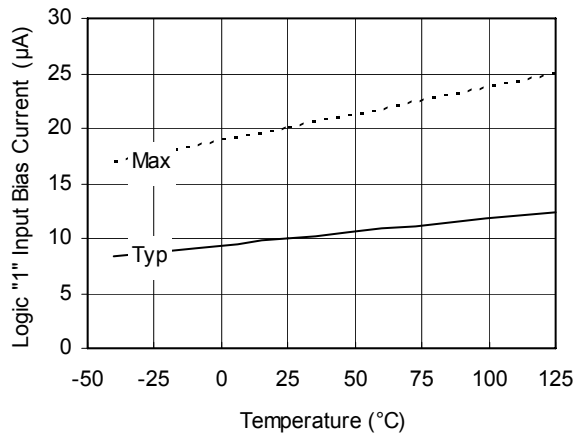

Figure 15A. Logic "1" Input Bias Current vs. Temperature

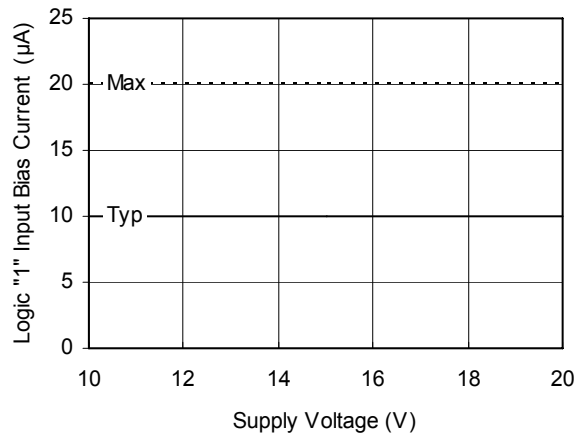

Figure 15B. Logic "1" Input Bias Current vs. Supply Voltage

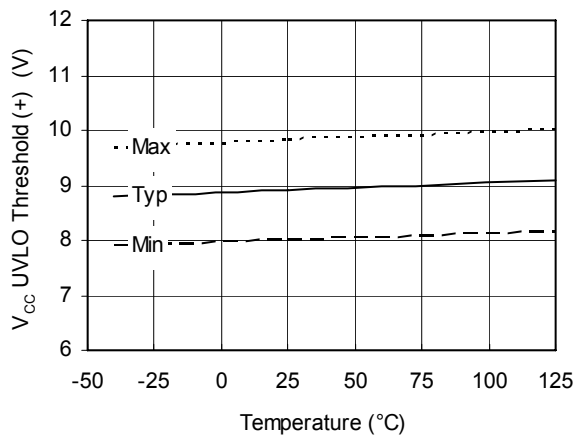

Figure 16. V_{CC} Undervoltage Threshold (+) vs. Temperature

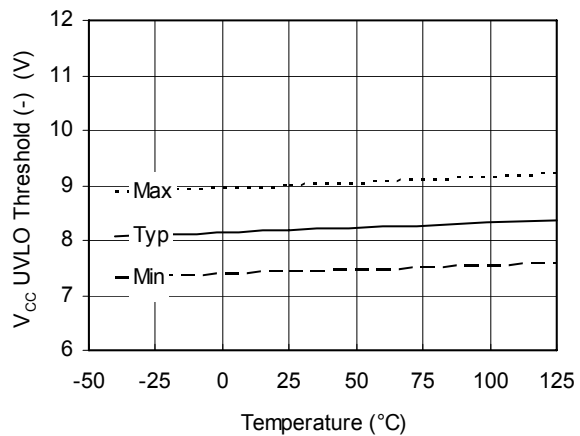

Figure 17. V_{CC} Undervoltage Threshold (-) vs. Temperature

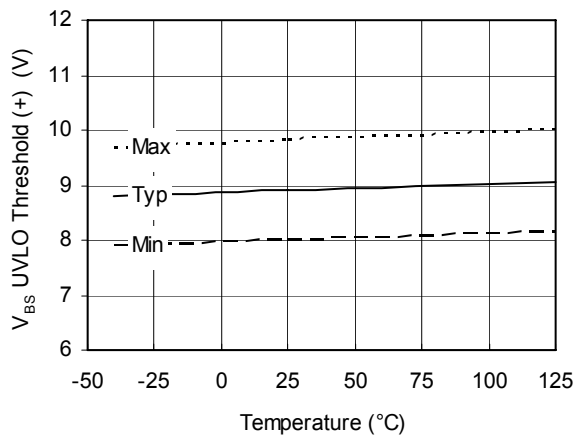

Figure 18. V_{BS} Undervoltage Threshold (+) vs. Temperature

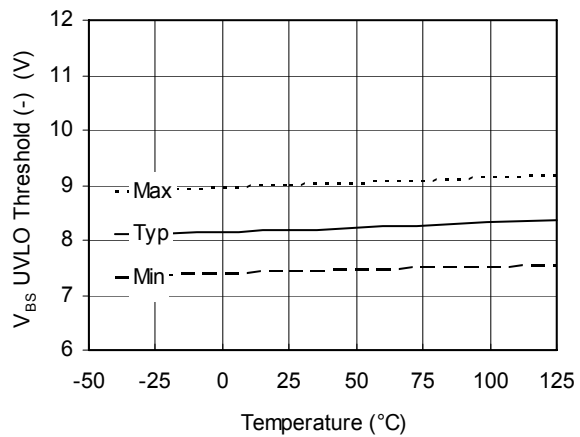

Figure 19. V_{BS} Undervoltage Threshold (-) vs. Temperature

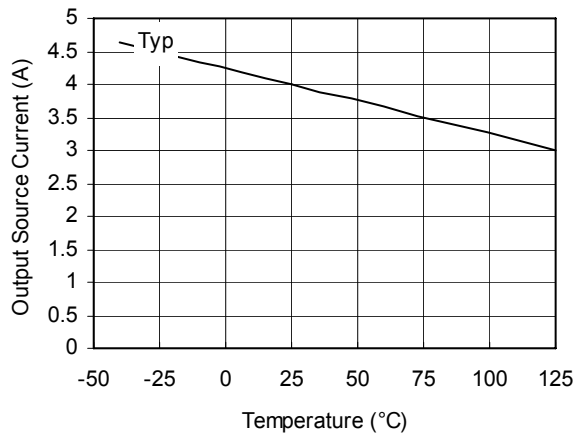

Figure 20A. Output Source Current vs. Temperature

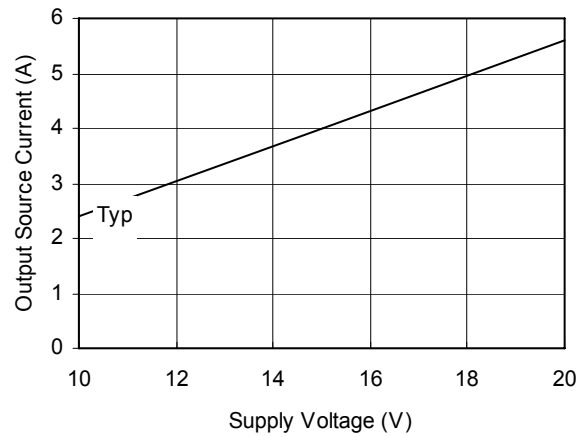

Figure 20B. Output Source Current vs. Supply Voltage

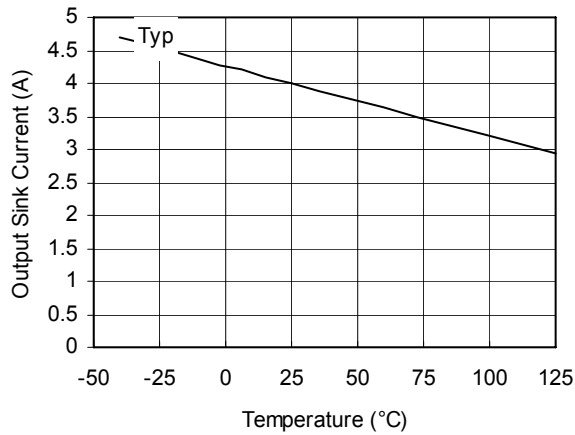

Figure 21A. Output Sink Current vs. Temperature

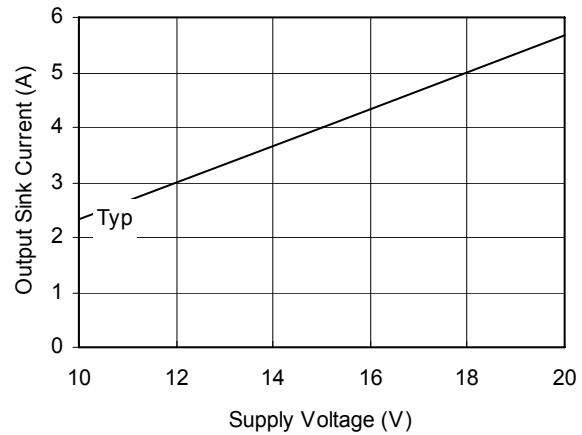
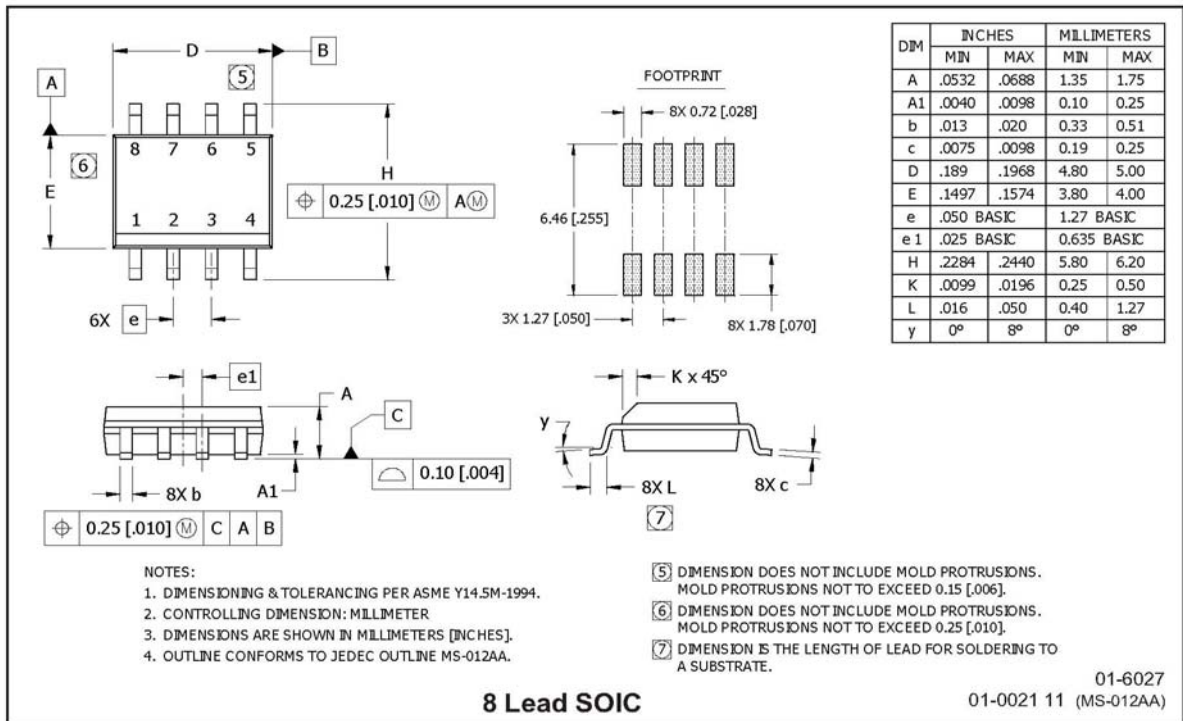
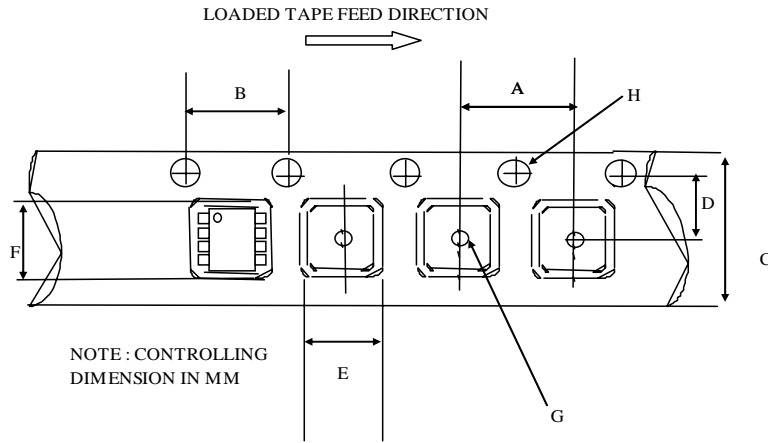

Figure 21B. Output Sink Current vs. Supply Voltage

Package Details, SOIC8N



Package Details: SOIC8N, Tape and Reel



CARRIER TAPE DIMENSION FOR 8SOICN

Code	Metric		Imperial	
	Min	Max	Min	Max
A	7.90	8.10	0.311	0.318
B	3.90	4.10	0.153	0.161
C	11.70	12.30	0.46	0.484
D	5.45	5.55	0.214	0.218
E	6.30	6.50	0.248	0.255
F	5.10	5.30	0.200	0.208
G	1.50	n/a	0.059	n/a
H	1.50	1.60	0.059	0.062

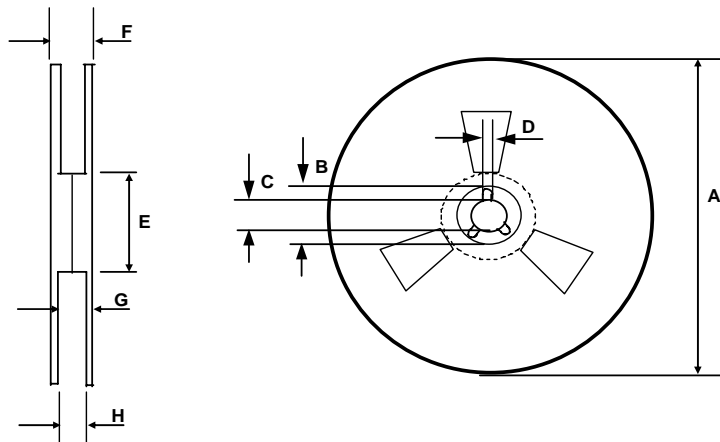

REEL DIMENSIONS FOR 8SOICN

Code	Metric		Imperial	
	Min	Max	Min	Max
A	329.60	330.25	12.976	13.001
B	20.95	21.45	0.824	0.844
C	12.80	13.20	0.503	0.519
D	1.95	2.45	0.767	0.096
E	98.00	102.00	3.858	4.015
F	n/a	18.40	n/a	0.724
G	14.50	17.10	0.570	0.673
H	12.40	14.40	0.488	0.566

Part Marking Information

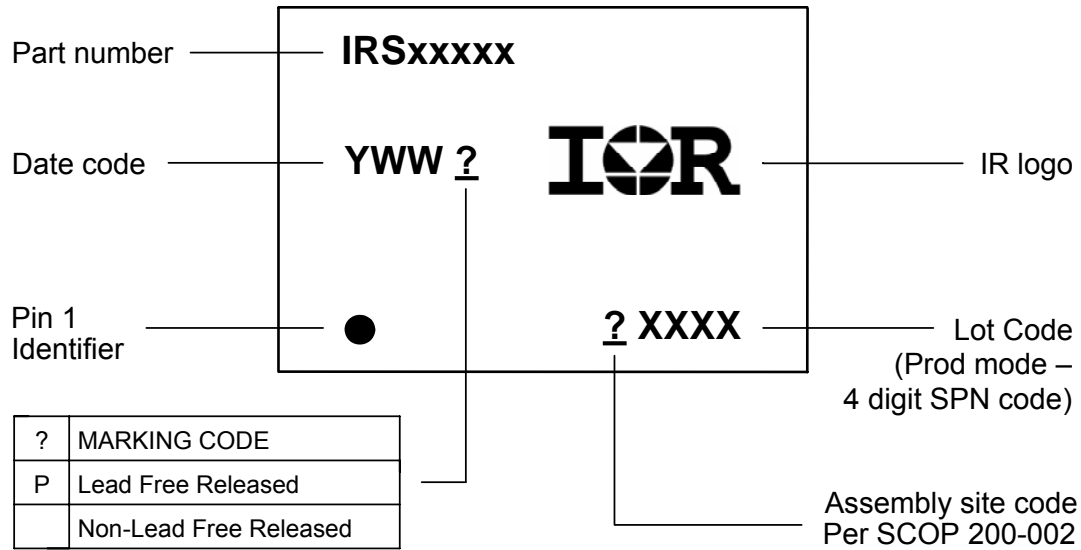

Ordering Information

Base Part Number	Package Type	Standard Pack		Complete Part Number
		Form	Quantity	
IRS21850SPBF	SOIC8N	Tube/Bulk	95	IRS21850SPBF
		Tape and Reel	2500	IRS21850STRPBF

The information provided in this document is believed to be accurate and reliable. However, International Rectifier assumes no responsibility for the consequences of the use of this information. International Rectifier assumes no responsibility for any infringement of patents or of other rights of third parties which may result from the use of this information. No license is granted by implication or otherwise under any patent or patent rights of International Rectifier. The specifications mentioned in this document are subject to change without notice. This document supersedes and replaces all information previously supplied.

For technical support, please contact IR's Technical Assistance Center
<http://www.irf.com/technical-info/>

WORLD HEADQUARTERS:
 233 Kansas St., El Segundo, California 90245
 Tel: (310) 252-7105

Mouser Electronics

Authorized Distributor

Click to View Pricing, Inventory, Delivery & Lifecycle Information:

[International Rectifier:](#)

[IRS21850STRPBF](#) [IRS21850SPBF](#)