

# VLA502-01

DRIVER FOR IGBT MODULES

## DESCRIPTION

VLA502-01 is a hybrid integrated circuit designed for driving N-channel IGBT modules in any gate-amplifier application. VLA502 is the high-speed version of VLA500.

This device include the isolated type DC-DC converter for a Gate drive. Therefore design of the gate power supply is not required.

The system of built-in short circuit protection provide a margin to time by function to maintain reverse bias for a predetermined time after the detection of short circuit.

Recommended IGBT modules:

$V_{CES} = 600V$  series up to 600A class

$V_{CES} = 1200V$  series up to 600A class

## FEATURES

- Built-in the isolated type DC-DC converter for gate drive
- Propagation delay time : 0.4us(typ)
- SIP outline allows more space on mounting area
- Variable fall time on activity of short circuit protection<sup>(\*)</sup>
- Electrical isolation voltage between input and output is 2500Vrms (for 1minute)
- CMOS, TTL compatible

<sup>(\*)</sup> Please note that IGBT modules of "Mitsubishi NFH series" is not guaranteed for short-circuit.

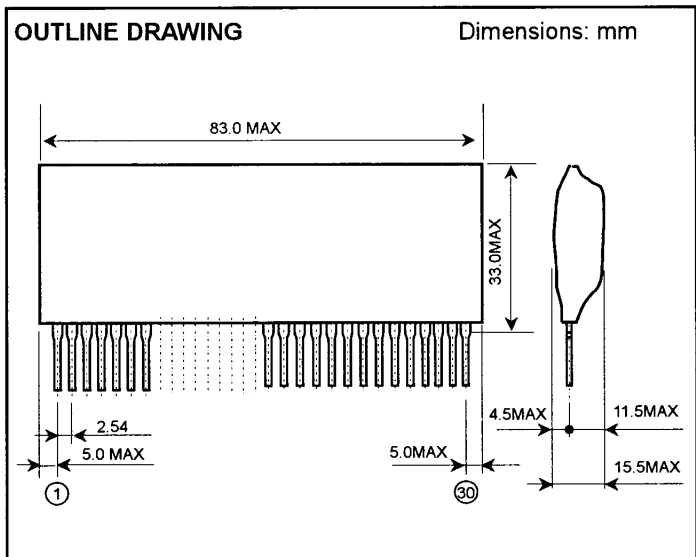

## APPLICATIONS

To drive IGBT modules for Induction heating, Power supply, Inverter or AC servo systems application

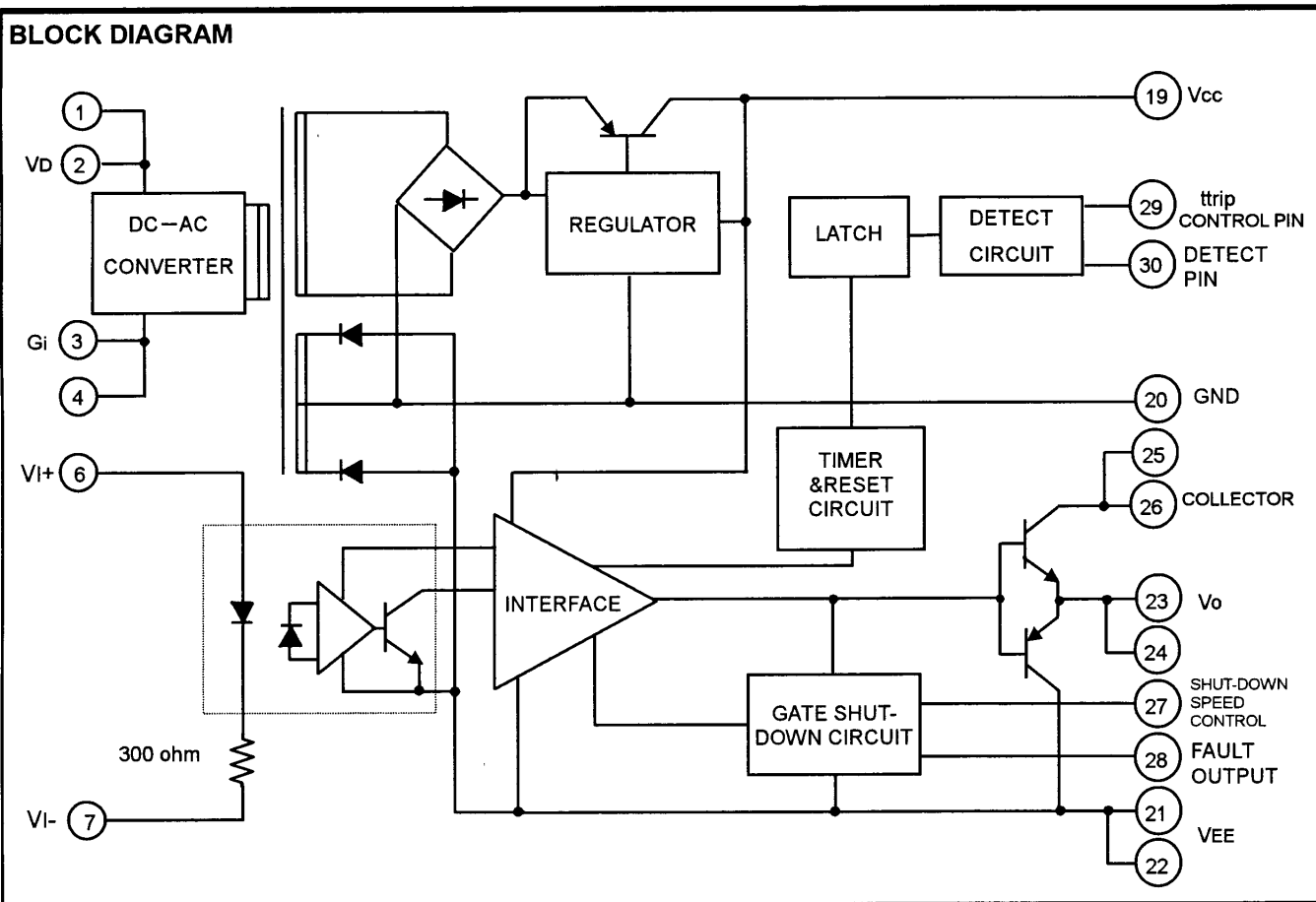

**MAXIMUM RATINGS** (Unless otherwise noted, Ta=25°C)

Symbol	Parameter	Conditions	Ratings	Unit
V <sub>D</sub>	Supply voltage	DC	-1~16.5	V
V <sub>I</sub>	Input signal voltage	Applied between pin 6 - 7 50% duty cycle, pulse width 1ms	-1 ~ +7	V
V <sub>O</sub>	Output voltage	When the output voltage is "H"	V <sub>CC</sub>	V
I <sub>OHP</sub>	Output current	Pulse width 2μs	-12	A
I <sub>OLP</sub>			12	A
V <sub>iso</sub>	Isolation voltage	Sine wave voltage 60Hz, for 1min.	2500	V <sub>rms</sub>
T <sub>C1</sub>	Case temperature1	Surface temperature(opto-coupler mounting part) (*3)	85	°C
T <sub>C2</sub>	Case temperature2	Surface temperature(excepting opto-coupler mounting part)	100	°C
T <sub>opr</sub>	Operating temperature	No condensation allowable	-20 ~ +60	°C
T <sub>stg</sub>	Storage temperature	No condensation allowable	-25 ~ +100 (*1)	°C
I <sub>FO</sub>	Fault output current	Applied pin 28	20	mA
V <sub>R30</sub>	Input voltage to pin 30	Applied pin 30	50	V
I <sub>drive</sub>	Gate drive current	Gate average current	210 (*2)	mA

(\*1) Differs from H/C condition

(\*2) Refer to I<sub>drive</sub>-T<sub>a</sub> CHARACTERISTICS (Needs derating)

(\*3) Refer to the below figure.

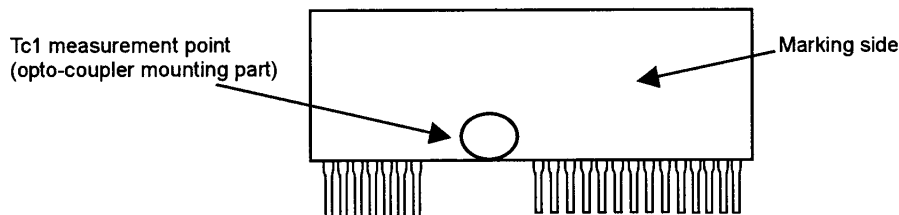
**ELECTRICAL CHARACTERISTICS** (Unless otherwise noted, Ta=25°C, V<sub>D</sub>=15V, R<sub>G</sub>=2.2 ohm)

Symbol	Parameter	Conditions	Limits			Unit
			Min	Typ	Max	
V <sub>D</sub>	Supply voltage	Recommended range	14.2	15	15.8	V
V <sub>IN</sub>	Pull-up voltage on input side	Recommended range	4.75	5	5.25	V
I <sub>IH</sub>	"H" input current	Recommended range	9.5	10	14	mA
f	Switching frequency	Recommended range	-	-	60	kHz
R <sub>G</sub>	Gate resistance	Recommended range	1	-	-	ohm
I <sub>IH</sub>	"H" input current	V <sub>IN</sub> = 5V	-	10	-	mA
V <sub>CC</sub>	Gate positive supply voltage	—	15.2	-	17.5	V
V <sub>EE</sub>	Gate negative supply voltage	—	-6	-	-11.5	V
Eta	Gate supply efficiency	Load current = 210mA Eta = (V <sub>CC</sub> + V <sub>EE</sub>  ) x 0.21 / (15 x I <sub>D</sub> ) x 100	60	75	-	%
V <sub>OH</sub>	"H" output voltage	10k ohm connected between pin 23-20	14	15.3	16.5	V
V <sub>OL</sub>	"L" output voltage	10k ohm connected between pin 23-20	-5.5	-	-11	V
t <sub>PLH</sub>	"L-H" propagation delay time	I <sub>IH</sub> = 10mA	0.25	0.4	0.65	μs
t <sub>r</sub>	"L-H" rise time	I <sub>IH</sub> = 10mA	-	0.3	1	μs
t <sub>PHL</sub>	"H-L" propagation delay time	I <sub>IH</sub> = 10mA	0.25	0.4	0.65	μs
t <sub>f</sub>	"H-L" fall time	I <sub>IH</sub> = 10mA	-	0.3	1	μs
t <sub>timer</sub>	Timer	Between start and cancel (under input sign "L")	1	-	2	ms
I <sub>FO</sub>	Fault output current	Applied pin 28, R = 4.7k ohm	-	5	-	mA
t <sub>trip1</sub>	Controlled time detect short circuit 1	Pin 30 : 15V and more, pin 29 : open	-	1.8	-	μs
t <sub>trip2</sub>	Controlled time detect short circuit 2 (*4)	Pin 30 : 15V and more, pin 29-21,22 : 10pF (connective capacitance)	-	2.2	-	μs
V <sub>SC</sub>	SC detect voltage	Collector voltage of module	15	-	-	V

(\*4) Length of wiring of condenser controlled time detect short-circuit is within 5cm from pin 21,22 and 29 coming and going.

PERFORMANCE CURVES

$V_{CC}, |V_{EE}| - T_a$  CHARACTERISTICS (TYPICAL)

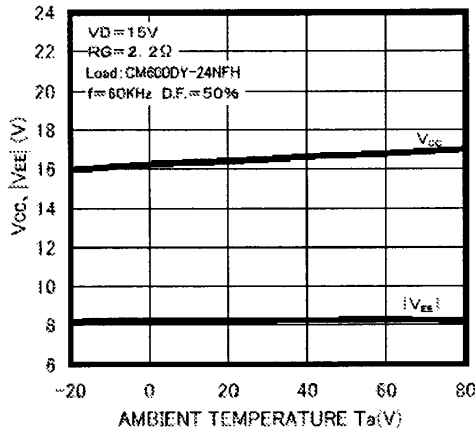

$V_{CC}, |V_{EE}| - I_o$  CHARACTERISTICS (TYPICAL)

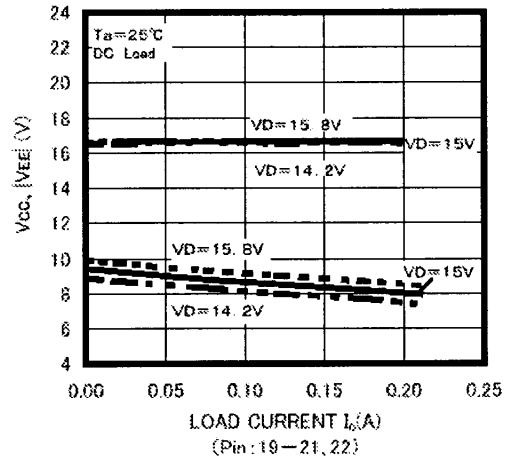

t<sub>PLH</sub>, t<sub>PHL</sub> - T<sub>a</sub> CHARACTERISTICS (TYPICAL)

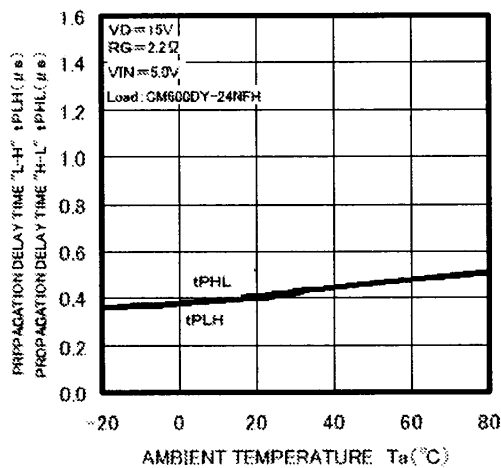

t<sub>PLH</sub>, t<sub>PHL</sub> - V<sub>I</sub> CHARACTERISTICS (TYPICAL)

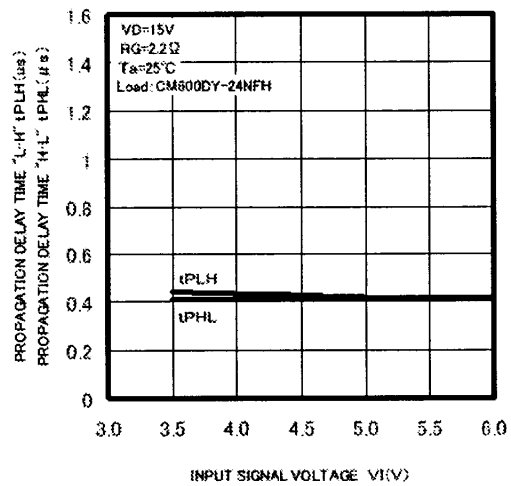

t<sub>trip</sub> - T<sub>a</sub> CHARACTERISTICS (TYPICAL)

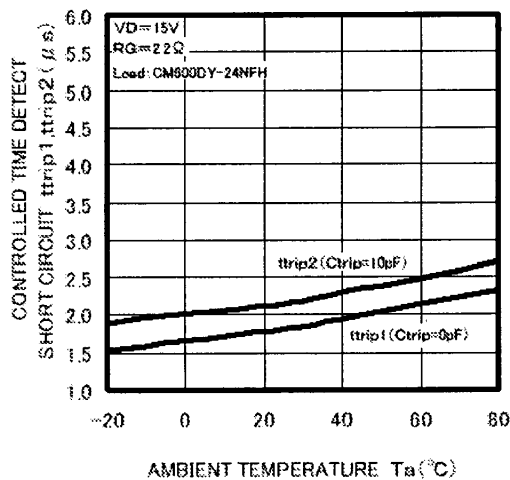

t<sub>trip</sub> - C<sub>trip</sub> CHARACTERISTICS (TYPICAL)

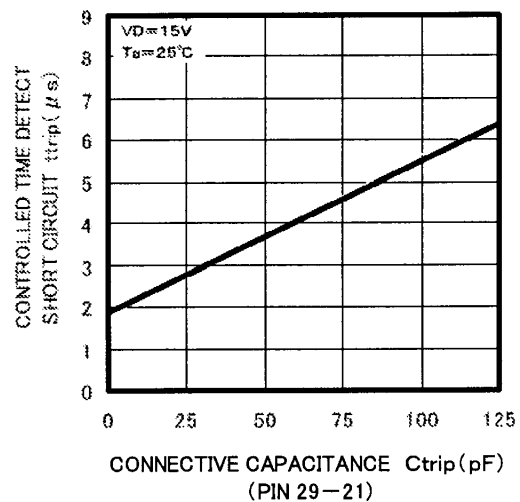

$I_D - I_D$  CHARACTERISTICS  
(TYPICAL)

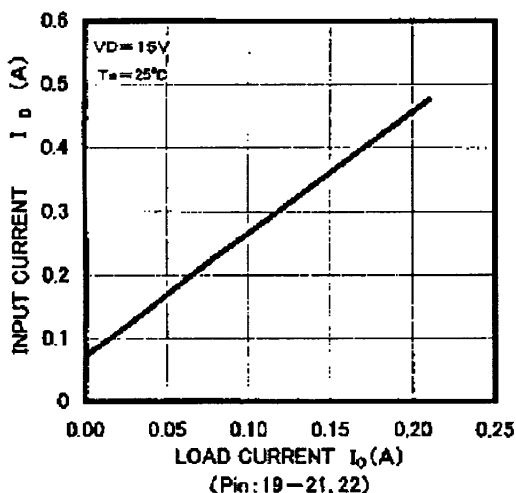

VOH, [VOL] -  $T_a$  CHARACTERISTICS  
(TYPICAL)

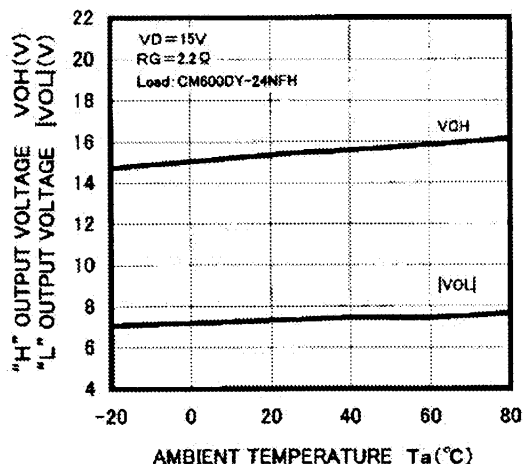

$\eta_{ta} - I_{drive}$  CHARACTERISTICS  
(TYPICAL)

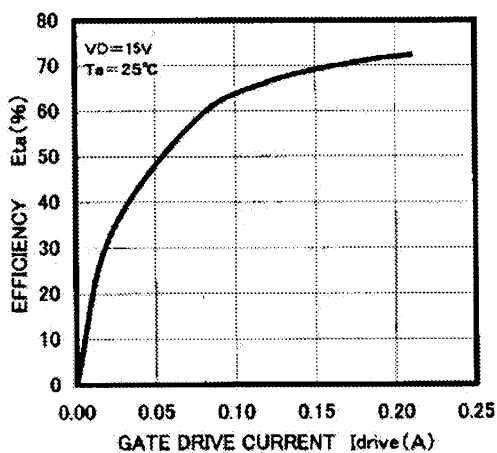

$V_{CC}, |V_{EE}| - V_D$  CHARACTERISTICS  
(TYPICAL)

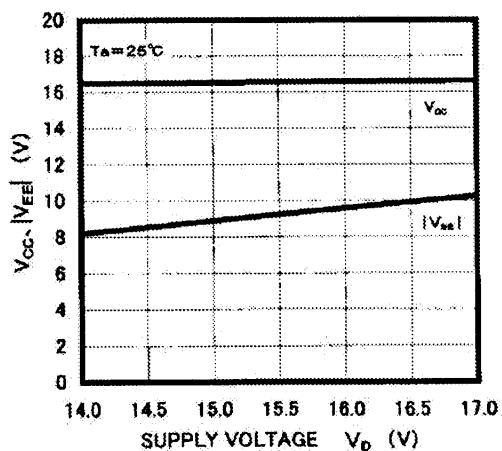

$I_{drive} - T_a$  CHARACTERISTICS  
(MAXIMUM RATING)

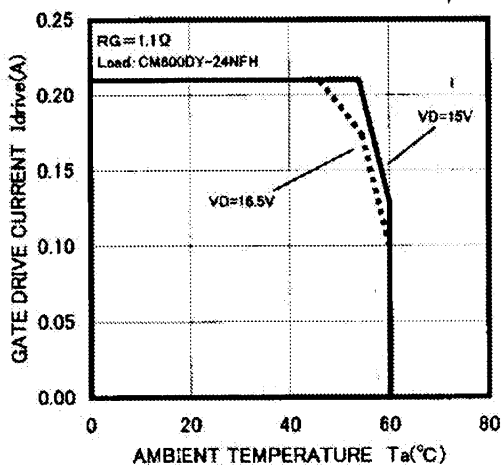

$\eta_{ta} - V_D$  CHARACTERISTICS  
(TYPICAL)

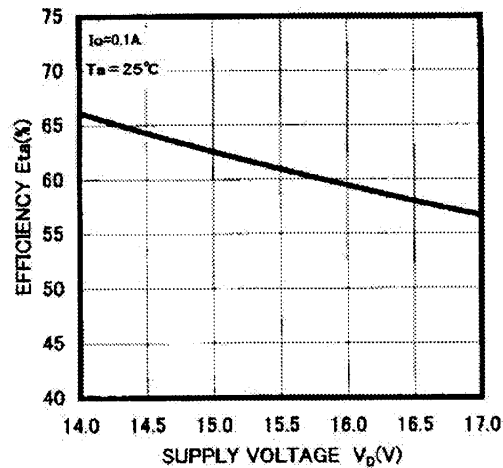

DEFINITION OF CHARACTERISTICS

(1) SWITCHING OPERATION

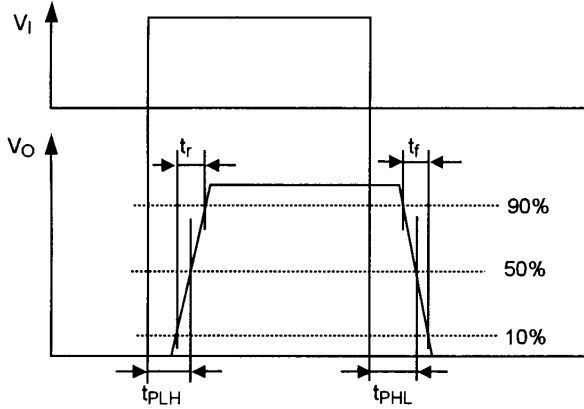

(2) OPERATION OF SHORT CIRCUIT PROTECTION

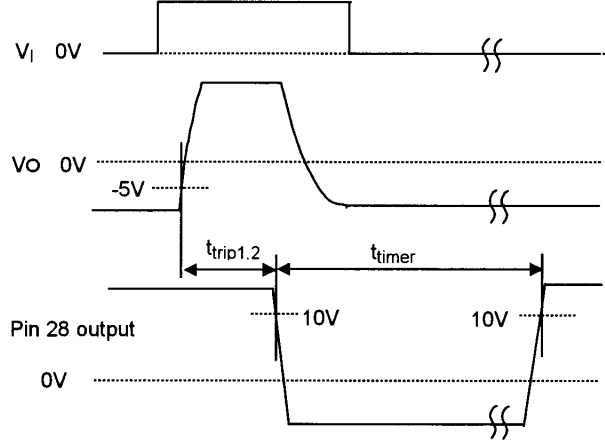

APPLICATION EXAMPLE

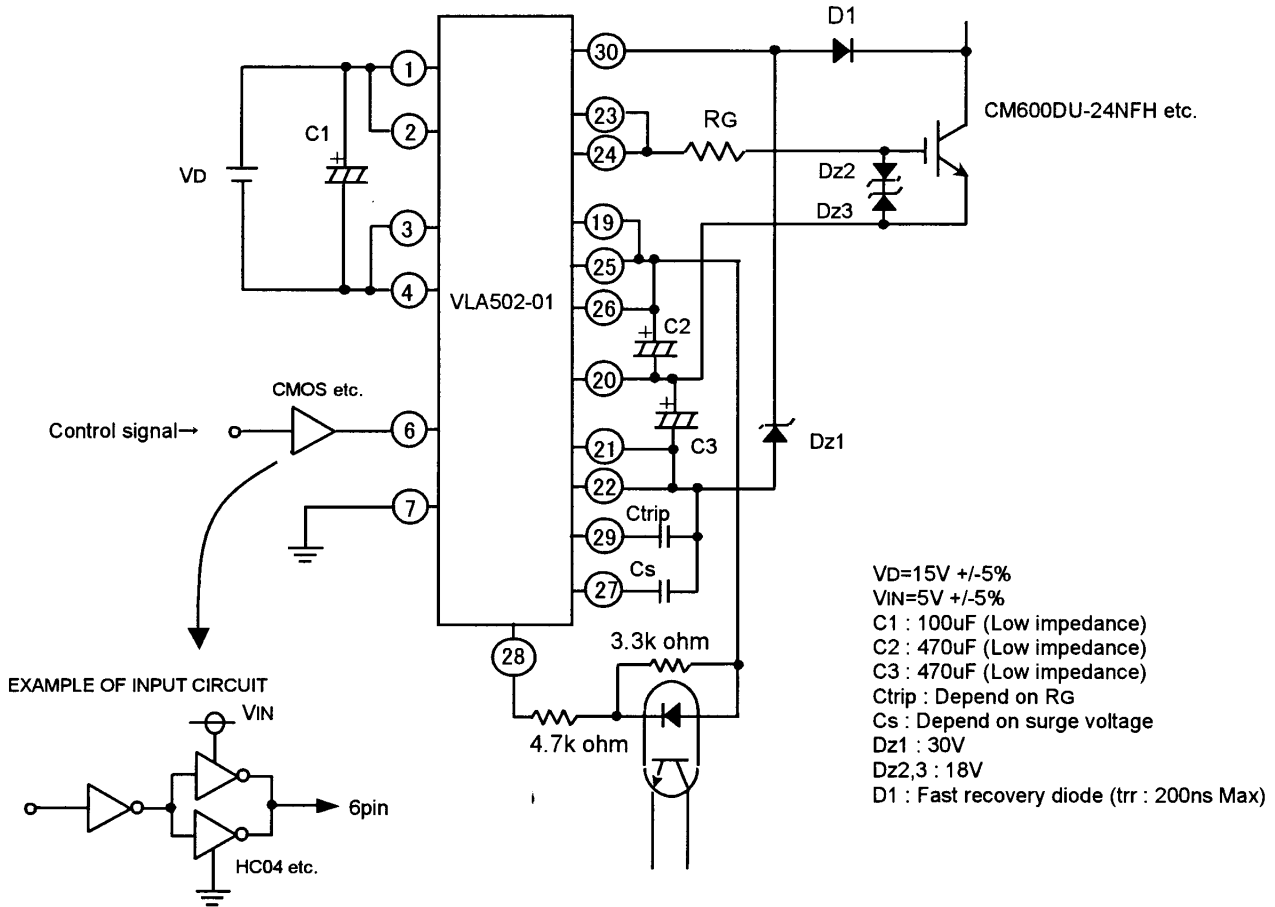

PRECAUTION

- (1) Voltage compensate capacitors are expected to be located as close as possible to the Hybrid IC.
- (2) Minimize the area of closed circuit of gate circuit so as not to be affected by induction noise.
- (3) D1 requires approximately the same voltage of power modules.
- (4) When recovery current flow in D1 , pin 30 is applied high voltage .  
In that case , counterplan for protection which insert a zener diode between pin 21,22 and 30 are necessary like above diagram.
- (5) Please note that IGBT modules of "Mitsubishi NFH series" is not guaranteed for short-circuit.
- (6) When the built in short-circuit protection circuit need not be used, please connect resistance of 4.7k ohm between pin 30 and 20. (D1 and Dz1 are not required.)

**OPERATION OF PROTECTION CIRCUIT**

- (1) In case the gate voltage is "H" and the collector voltage is high, this Hybrid IC will recognize the circuit as short circuit and immediately reduce the gate voltage. Besides, put out a fault sign ("L") which inform that protection circuit is operating at the same time from pin 28.
- (2) The protection circuit reset and resorted to ordinary condition if input sign is "L" when the predetermined time(1 ~ 2ms) passed. ("L" period needs 15us or more)
- (3) When the output rises, the controlled time detect short circuit (Typ 1.8us) is set up so that on-time of IGBT can be secured properly. It is possible to adjust that time by connecting the capacitor (Ctrip) between pin 21,22 and 29.

**ADJUSTMENT OF OUTPUT FALL TIME**

(When the protection circuit is operating)

In case you want to decrease the speed of reverse bias when the protection circuit is operating, you can adjust that speed by connecting the capacitor (Cs) between pin 21,22 and 27.

(Please refer to under figures.)

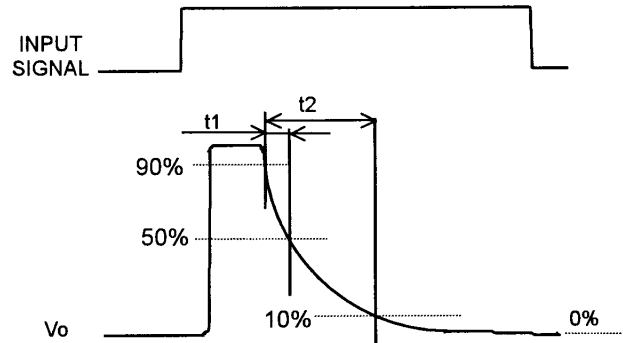

**OPERATION FLOW ON DETECTING SHORT CIRCUIT**

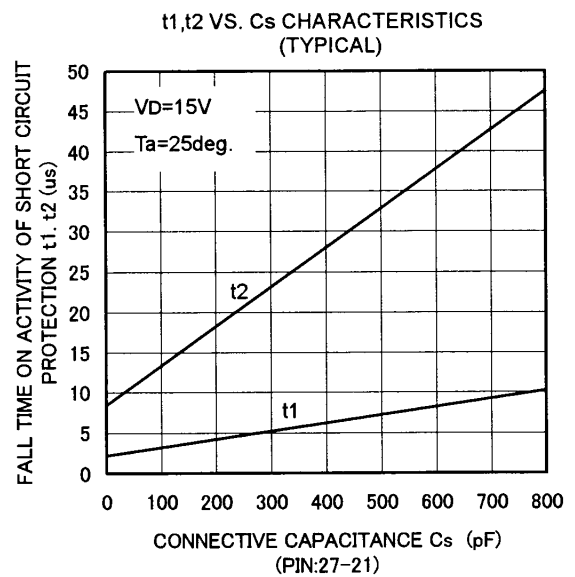
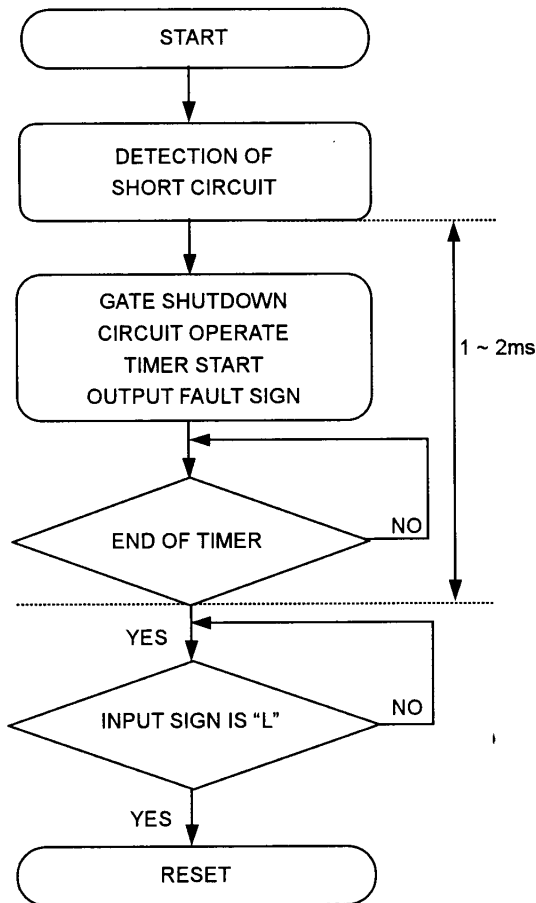

Note : "L" output voltage with protection circuit operating is about VEE + 2V.

**FOR SAFETY USING**

Great detail and careful attention are given to the production activity of Hics, such as the development, the quality of production, and in its reliability. However the reliability of Hics depends not only on their own factors but also in their condition of usage. When handling Hics, please note the following cautions.

CAUTIONS	
Packing	<p>The materials used in packing Hics can only withstand normal external conditions. When exposed to outside shocks, rain and certain environmental contaminators, the packing materials will deteriorates. Please take care in handling.</p>
Carrying	<ol style="list-style-type: none"> <li>1) Don't stack boxes too high. Avoid placing heavy materials on boxes.</li> <li>2) Boxes must be positioned correctly during transportation to avoid breakage.</li> <li>3) Don't throw or drop boxes.</li> <li>4) Keep boxes dry. Avoid rain or snow.</li> <li>5) Minimal vibration and shock during transportation is desirable.</li> </ol>
Storage	<p>When storing Hics, please observe the following notices or possible deterioration of their electrical characteristics, risk of solder ability, and external damage may occur.</p> <ol style="list-style-type: none"> <li>1) Devices must be stored where fluctuation of temperature and humidity is minimal, and must not be exposed to direct sunlight. Store at the normal temperature of 5 to 30 degrees Celsius with humidity at 40 to 60%.</li> <li>2) Avoid locations where corrosive gasses are generated or where much dust accumulates.</li> <li>3) Storage cases must be static proof.</li> <li>4) Avoid putting weight on boxes.</li> </ol>
Extended storage	<p>When extended storage is necessary, Hics must be kept non-processed. When using Hics which have been stored for more than one year or under severe conditions, be sure to check that the exterior is free from flaw and other damages.</p>
Maximum ratings	<p>To prevent any electrical damages, use Hics within the maximum ratings. The temperature, current, voltage, etc. must not exceed these conditions.</p>
Polarity	<p>To protect Hics from destruction and deterioration due to wrong insertion, make sure of polarity in inserting leads into the board holes, conforming to the external view for the terminal arrangement.</p>

***IDC* ISAHAYA ELECTRONICS CORPORATION**

*Marketing division, Marketing planning department*

6-41 Tsukuba, Isahaya, Nagasaki, 854-0065 Japan

**Keep safety first in your circuit designs!**

· ISAHAYA Electronics Corporation puts the maximum effort into making semiconductor products better and more reliable, but there is always the possibility that trouble may occur with them. Trouble with semiconductors may lead to personal injury, fire or property damage. Remember to give due consideration to safety when making your circuit designs, with appropriate measures such as (1) placement of substitutive, auxiliary circuits, (2) use of non-flammable material or (3) prevention against any malfunction or mishap.

**Notes regarding these materials**

- These materials are intended as a reference to our customers in the selection of the ISAHAYA products best suited to the customer's application; they don't convey any license under any intellectual property rights, or any other rights, belonging to ISAHAYA or a third party.
- ISAHAYA Electronics Corporation assumes no responsibility for any damage, or infringement of any third party's rights, originating in the use of any product data, diagrams, charts or circuit application examples contained in these materials.
- All information contained in these materials, including product data, diagrams and charts, represent information on products at the time of publication of these materials, and are subject to change by ISAHAYA Electronics Corporation without notice due to product improvements or other reasons. It is therefore recommended that customers contact ISAHAYA Electronics Corporation or an authorized ISAHAYA products distributor for the latest product information before purchasing product listed herein.
- ISAHAYA Electronics Corporation products are not designed or manufactured for use in a device or system that is used under circumstances in which human life is potentially at stake. Please contact ISAHAYA Electronics Corporation or an authorized ISAHAYA products distributor when considering the use of a product contained herein for any specific purposes, such as apparatus or systems for transportation, vehicular, medical, aerospace, nuclear, or undersea repeater use.
- The prior written approval of ISAHAYA Electronics Corporation is necessary to reprint or reproduce in whole or in part these materials.
- If these products or technologies are subject to the Japanese export control restrictions, they must be exported under a license from the Japanese government and cannot be imported into a country other than the approved destination. Any diversion or re-export contrary to the export control laws and regulations of Japan and/or the country of destination is prohibited.
- Please contact ISAHAYA Electronics Corporation or authorized ISAHAYA products distributor for further details on these materials or the products contained therein.