





Miniature Toggle Switch MTS-102-A1-2

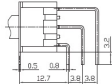

Specification

1. Product Name : MTS-102-A1-2
2. Rating : 6A 125VAC ; 3A 250VAC
3. Contact Resistance:20mΩ max
4. Insulation Resistance:500VDC 1000MΩ min
5. Dielectric Strength:1500VAC 1Minute
6. Operating Temperature:-25°C~+85°C
7. Electrical Life:10000 Cycles
8. Terminal options:

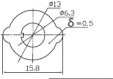
Solder terminal (1)	PC terminal (2)	PC-H terminal (3)	PC-V terminal (4)	Long Solder terminal (5)	Nameplate									
					 <table border="1" style="margin-top: 5px;"> <tr> <td>(1)</td> <td>ON</td> <td>OFF</td> </tr> <tr> <td>(2)</td> <td>ON</td> <td>ON</td> </tr> <tr> <td>(3)</td> <td>ON</td> <td>ON</td> </tr> </table>	(1)	ON	OFF	(2)	ON	ON	(3)	ON	ON
(1)	ON	OFF												
(2)	ON	ON												
(3)	ON	ON												

9. Base color and material:

Material	Base color	
PBT	Blue	
Bakelite	Red	Black

10. Circuitry trait:ON-ON;(ON)-ON
11. Switch pin:SPDT 3P
12. Certification system : TUV、UL、IOS9001:2015、CE、ENECandOther

Product details and dimensions

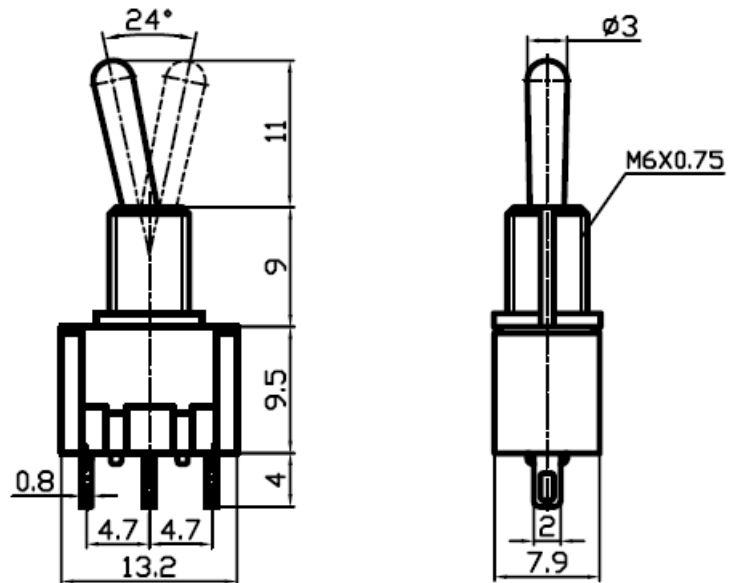
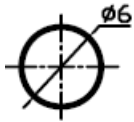

Company profile

Ningbo jietong electronics co., LTD. Is located in ningbo economic and technological development zone, zhejiang province, China. The existing factory building area of 10,000 square meters, more than 300 employees.

The company specializes in the production of various types of small electromechanical switches, the annual output of various switches about 50 million. The main products are switch, automobile switch, rocker arm switch, wave switch, button switch and other 15 series more than 2,000 specifications, is one of the mainland China switch manufacturing enterprises.

The company through is9001:2008 quality management system certification, quality management system sound, strong technical force, advanced testing equipment, main products have been the United States UL, Europe ENEC, TOV, KEMA, CE, Korea KTL and China CQC and other certification. The various materials used in the products have been tested by SGS to ensure that the products can be produced in accordance with the European RoHS directive.

The company has the right to import and export, more than 90% switch export Europe, North America, South America, Africa, the Middle East, South Korea, Taiwan, Hong Kong, southeast Asia and dozens of countries and regions.

"Jietong switch" with its reliable quality, complete variety, preferential prices, perfect service, win more and more merchants praise highly and welcome.



Certification system

The company has passed iso9001:2015 international quality management technology system certification, a sound quality management system, strong technical force, advanced testing equipment, the main products have been UL, ENEC, TUV, KEMA, CE and other safety certification, the materials used in the products have passed the SGS test, to ensure the compliance with the European RoHS directive products.



Product link : <https://www.jietongswitch.com/miniature-toggle-switch-mts-102-a1-2-products/>