

# Kingbright®

## 38mm (1.5 INCH) SINGLE DIGIT NUMERIC DISPLAYS

SA15-11  
SBA15-11

SC15-11  
SBC15-11

### Features

- 1.5 INCH DIGIT HEIGHT.
- LOW CURRENT OPERATION.
- EXCELLENT CHARACTER APPEARANCE.
- HIGH LIGHT OUTPUT.
- EASY MOUNTING ON P.C. BOARDS OR SOCKETS.
- I.C. COMPATIBLE.
- MULTICOLOR AVAILABLE.
- CATEGORIZED FOR LUMINOUS INTENSITY, YELLOW AND GREEN CATEGORIZED FOR COLOR.
- MECHANICALLY RUGGED.
- STANDARD : GRAY FACE, WHITE SEGMENT.

### Description

The Bright Red source color devices are made with Gallium Phosphide Red Light Emitting Diode.

The Green source color devices are made with Gallium Phosphide Green Light Emitting Diode.

The High Efficiency Red source color devices are made with Gallium Arsenide Phosphide on Gallium Phosphide Orange Light Emitting Diode.

The Yellow source color devices are made with Gallium Arsenide Phosphide on Gallium Phosphide Yellow Light Emitting Diode.

The Super Bright Red source color devices are made with Gallium Aluminum Arsenide Red Light Emitting Diode .

Package Dimensions

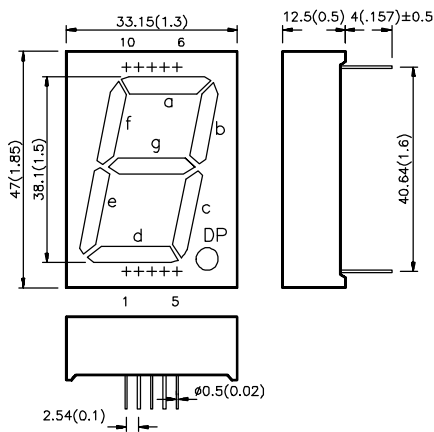

Internal Circuit Diagram

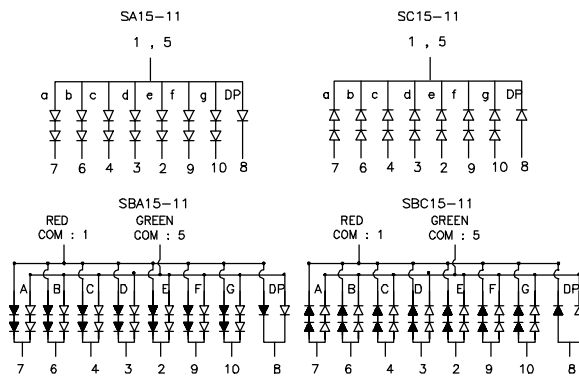

### Notes:

1. All dimensions are in millimeters (inches). Tolerance is  $\pm 0.25(0.01)$  unless otherwise noted.
2. Specifications are subjected to change without notice.

### Selection Guide

Part No.	Dice	Iv (ucd) @ 10 mA		Description
		Min.	Max.	
SA15-11HWA	BRIGHT RED (GaP)	900	2200	Common Anode, Rt Hand Decimal
SC15-11HWA				Common Cathode, Rt. Hand Decimal
SA15-11EWA	HIGH EFFICIENCY RED (GaAsP/GaP)	3600	21000	Common Anode, Rt Hand Decimal
SC15-11EWA				Common Cathode, Rt. Hand Decimal
SA15-11GWA	GREEN (GaP)	3600	9000	Common Anode, Rt Hand Decimal
SC15-11GWA				Common Cathode, Rt. Hand Decimal
SA15-11YWA	YELLOW (GaAsP/GaP)	3600	9000	Common Anode, Rt Hand Decimal
SC15-11YWA				Common Cathode, Rt. Hand Decimal
SA15-11SRWA	SUPER BRIGHT RED (GaAlAs)	14000	31000	Common Anode, Rt Hand Decimal
SC15-11SRWA				Common Cathode, Rt. Hand Decimal
SBA15-11EGWA	HIGH EFFICIENCY RED (GaAsP/GaP)	3600	21000	Common Anode, Rt Hand Decimal
SBC15-11EGWA	GREEN (GaP)	3600	9000	Common Cathode, Rt. Hand Decimal

### Electrical / Optical Characteristics at T<sub>A</sub>=25° C

Symbol	Parameter	Device	Typ.	Max.	Units	Test Conditions
$\lambda_{peak}$	Peak Wavelength	Bright Red High Efficiency Red Green Yellow Super Bright Red	700 625 565 590 660		nm	IF=20mA
$\Delta\lambda_{1/2}$	Spectral Line Halfwidth	Bright Red High Efficiency Red Green Yellow Super Bright Red	45 45 30 35 20		nm	IF=20mA
C	Capacitance	Bright Red High Efficiency Red Green Yellow Super Bright Red	40 12 45 10 95		pF	VF=0V;f=1MHz
V <sub>F</sub>	Forward Voltage	Bright Red High Efficiency Red Green Yellow Super Bright Red	2.0 2.0 2.2 2.1 1.85	2.5 2.5 2.5 2.5 2.5	V	IF=20mA
I <sub>R</sub>	Reverse Current	All	10		uA	VR = 5V

### Absolute Maximum Ratings at $T_A=25^\circ\text{C}$

Parameter	Bright Red	High Efficiency Red	Green	Yellow	Super Bright Red	Units
Power dissipation	120	105	105	105	100	mW
DC Forward Current	25	30	25	30	30	mA
Peak Forward Current [1]	150	150	150	150	150	mA
Reverse Voltage	5	5	5	5	5	V
Operating/Storage Temperature	-40 °C To +85 °C					
Lead Soldering Temperature [2]	260 °C For 5 Seconds					

Notes:  
 1. 1/10 Duty Cycle, 0.1ms Pulse Width.  
 2. 4mm below package base.

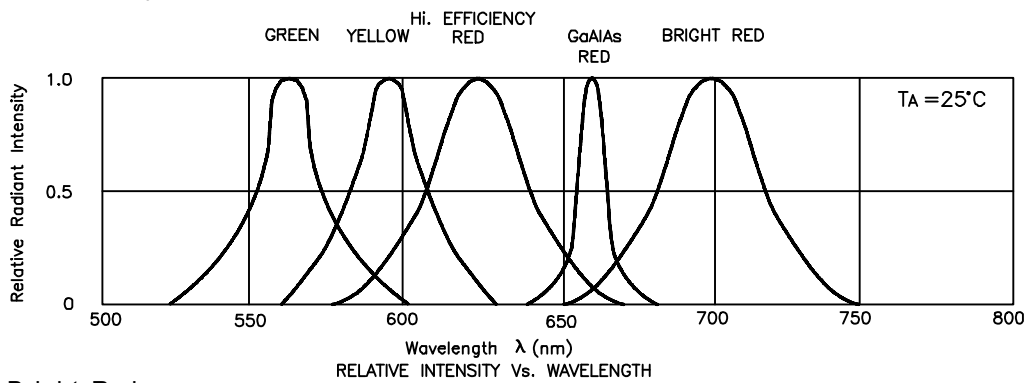

### Bright Red

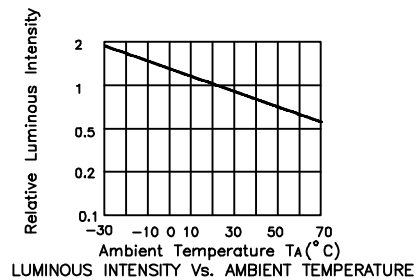
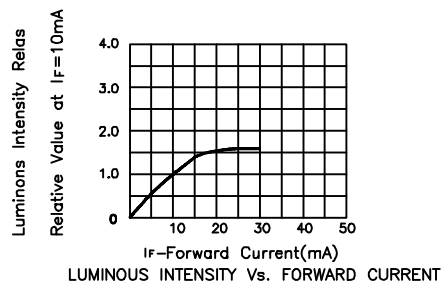
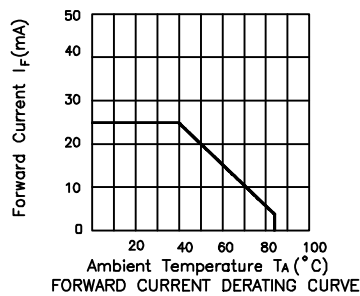
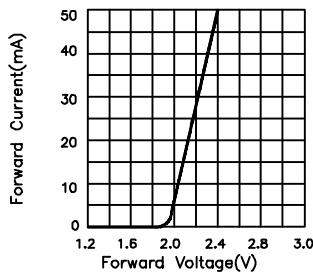

### High Efficiency Red

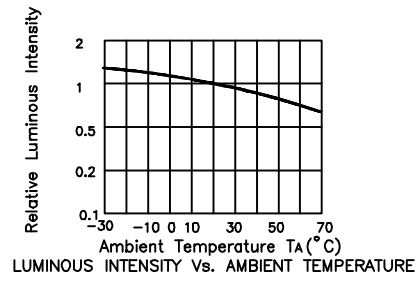
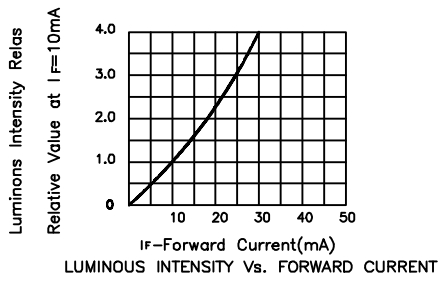
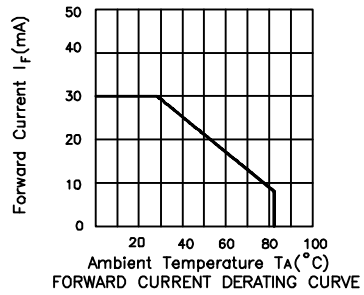
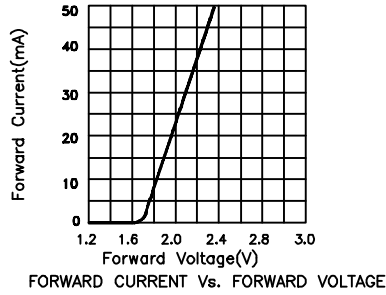

### Green

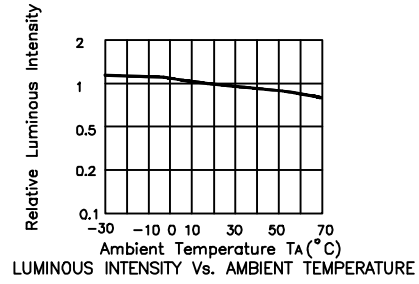
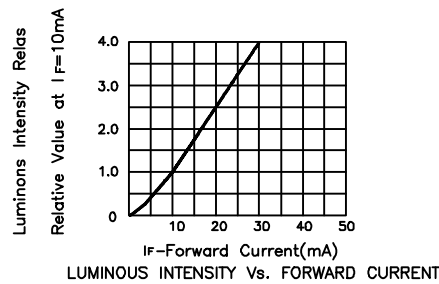
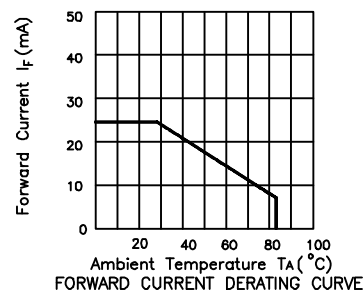
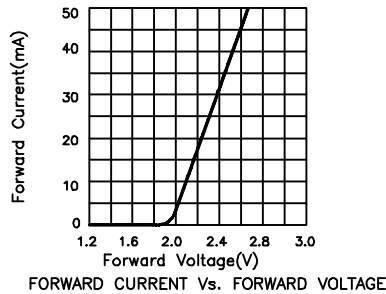

Yellow

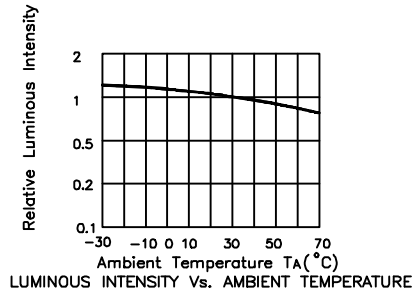
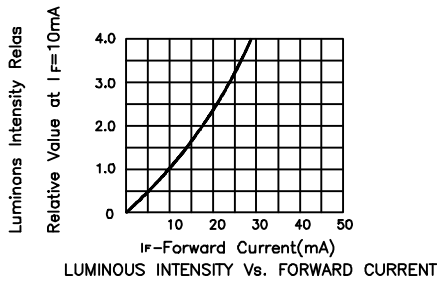
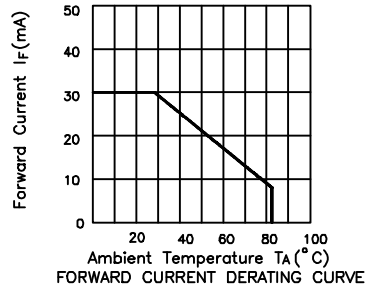
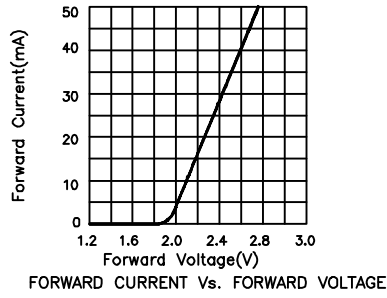

Super Bright Red

