

1 RoHS Compliance

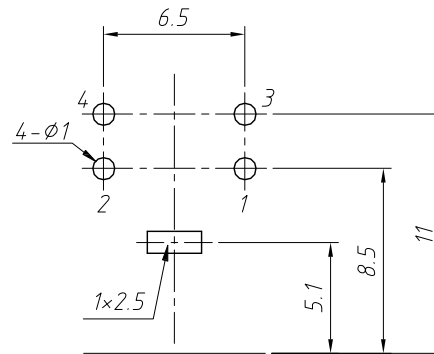
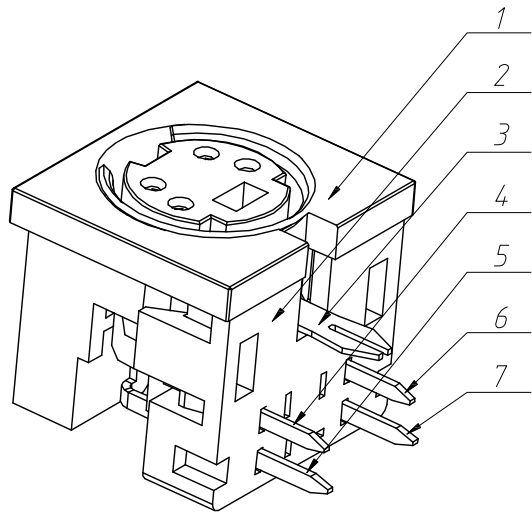
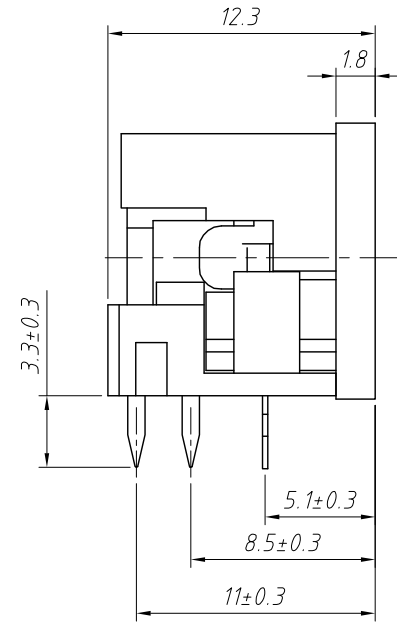
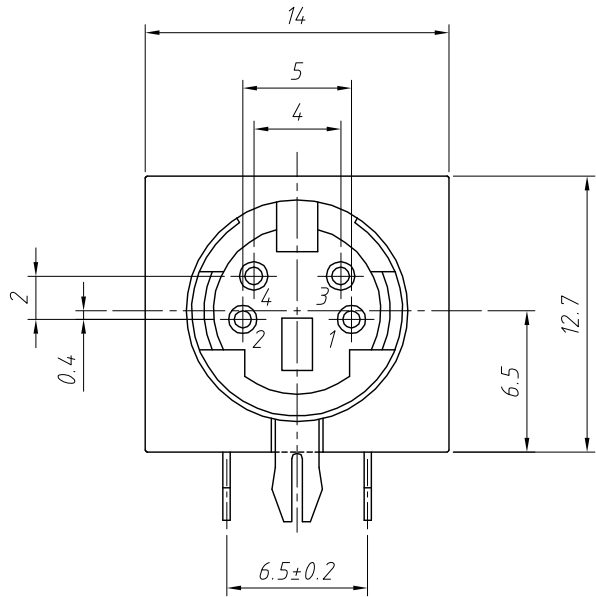

Material:

- 1. Insulator: PBT, UL 94V-0
- 2. Cover: PBT
- 3. Bao yuan: Brass with H62 Y1=0.25mm, D.Cu/Sn
- 4. Left short pin: Brass with H62 Y1=0.25mm, D.Cu/Sn
- 5. Left long pin: Brass with H62 Y1=0.25mm, D.Cu/Sn
- 6. Right long pin: Brass with H62 Y1=0.25mm, D.Cu/Sn
- 7. Right short pin: Brass with H62 Y1=0.25mm, D.Cu/Sn

Order Information:

L-KLS1-285A-XX-B

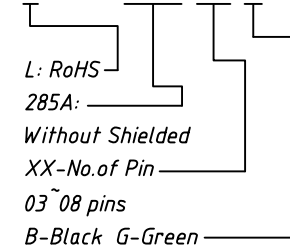

Electrical Characteristics:

1. Conditions of use

Ambient Temperature: -25°C ~ +70°C
Relative Humidity: 95% (40°C)

2. Contact current Rating: 2A 12V DC

3. Contact resistance: 30mΩ MAX

4. Insulation resistance: 100MΩ Min

5. Dielectric Withstanding: 250V AC (50Hz) 1 min.

6. Insertion and extraction force: 5-35N

7. Life: 5000 Cycles



ANGLE TOLERANCE	PROJECTION	Description:	
±3°		Mini Din Jack	
GENERAL TOLERANCE	UNITS	mm	KLS P/N:
x.x ±0.30	SHEET SIZE	A4	L-KLS1-285A-04-B
x.xx ±0.20	Draw:	Daniel	2018-07-10
x.xxx ±0.10	Check:	Daniel	2018-07-10

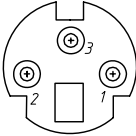
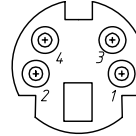
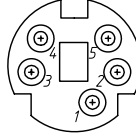
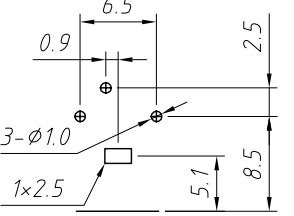
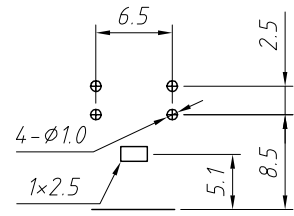
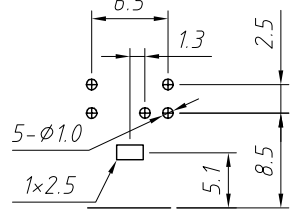
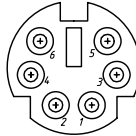
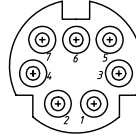
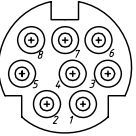
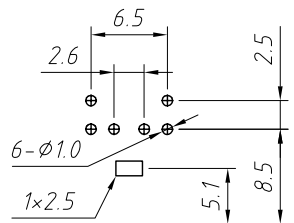
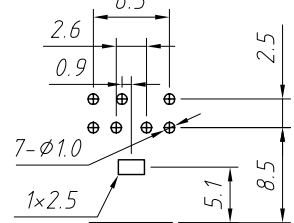
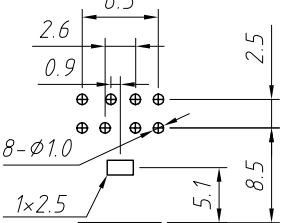

NingBo KLS ELECTRONIC CO.,LTD.

1
RoHS Compliance

ARRANGEMENT OF CONTACTS			
NO OF CONTACTS	3	4	5
PCB LAYOUT			
ARRANGEMENT OF CONTACTS			
NO OF CONTACTS	6	7	8
PCB LAYOUT			

ANGLE TOLERANCE		PROJECTION		Description:	
±3°				Mini Din Jack	
GENERAL TOLERANCE		UNITS	mm	KLS P/N:	L-KLS1-285A-XX-B
x.x	±0.30	SHEET SIZE	A4		
x.xx	±0.20	Draw:	Daniel	2018-07-10	 NingBo KLS ELECTRONIC CO.,LTD.
x.xxx	±0.10	Check:	Daniel	2018-07-10	