

Description

The DFI100PM12P4D1 offer lower losses and higher energy for application such as motor drive, inverter and other soft switching applications.

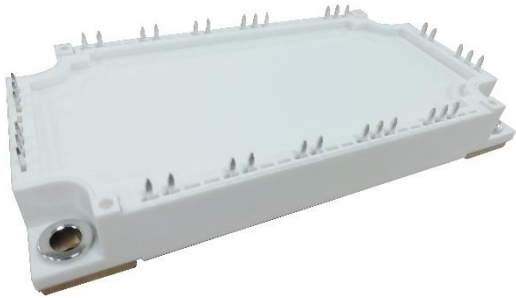

Features

- 1200V100A, VCE (sat) (typ.) = 2.10V
- Lower losses and higher energy
- Excellent short circuit ruggedness
- PIM module

Applications

- Inverter
- Power supply
- Motion/servo control

Circuit diagram

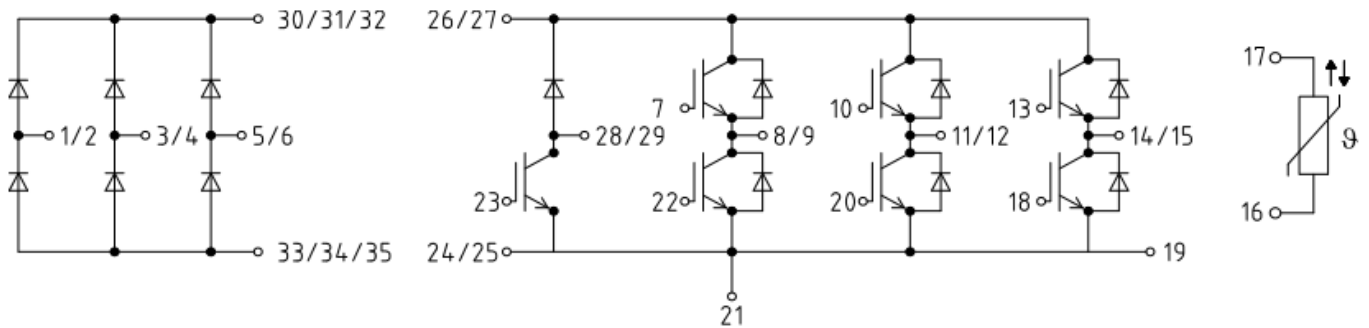

Figure 1. Out drawing & circuit diagram for DFI100PM12P4D1

Pin Configuration and Marking Information

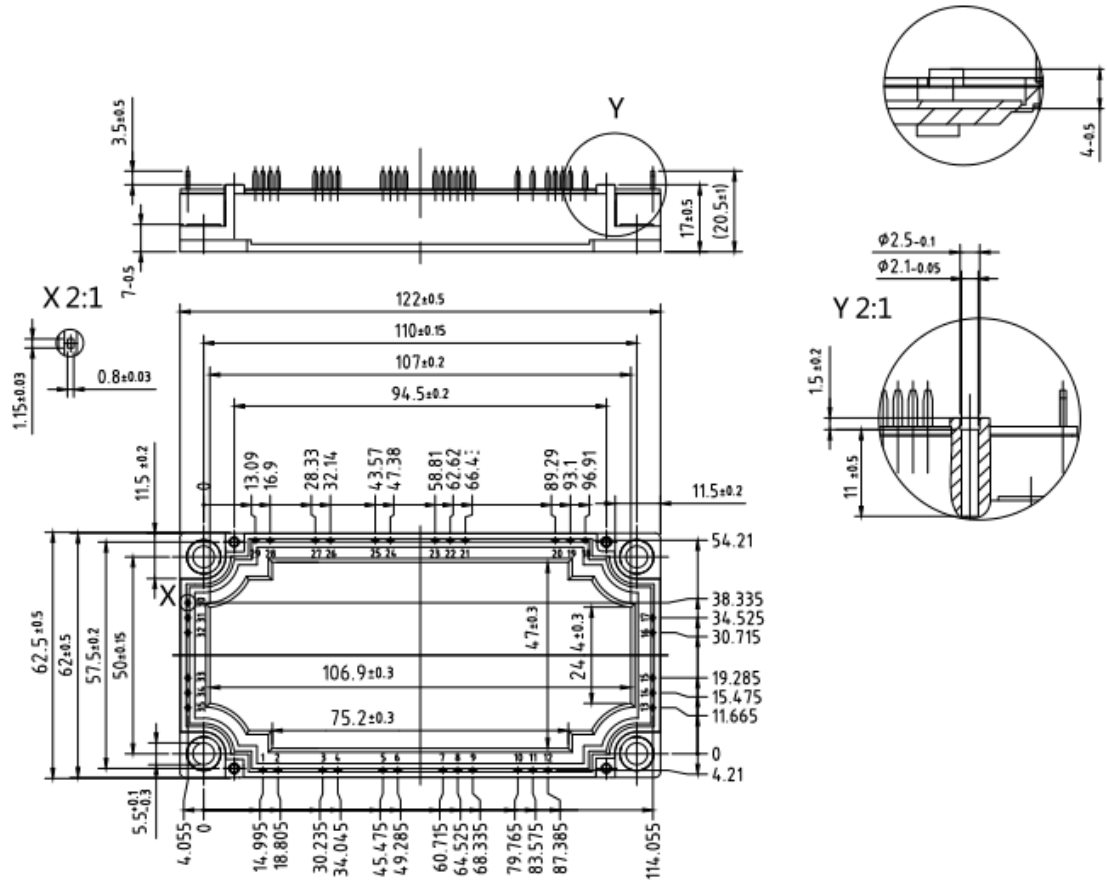

Figure 2. Pin configuration

Module

Parameter	Conditions	Value	Unit
Isolation Voltage	RMS, f =50Hz, t =1min	2.5	KV
Material of module baseplate	-	Cu	-
Creepage distance	terminal to heatsink terminal to terminal	17 3.81	mm
Clearance	terminal to heatsink terminal to terminal	17 3.81	mm
CTI	-	>200	-
Module lead resistance, terminals – chip	T _c =25°C	0.8	mΩ
Mounting torque for module mounting	M5	3 to 6	Nm
Weight	-	300	g

Maximum Ratings (IGBT, $T_j=25^{\circ}\text{C}$ unless otherwise specified)

Symbol	Parameter	Conditions	Ratings	Unit
V_{CES}	Collector-Emitter Voltage	G-E Short	1200	V
V_{RRM}	Peak Repetitive Revers Voltage	-	1200	V
V_{GES}	Gate-Emitter Voltage	C-E Short	$\pm 30\text{V}$	V
I_C	DC Continuous Collector Current	$T_C=100^{\circ}\text{C}$	100	A
I_{CM}	Pulse Collector Current	$t_p=1\text{ms}$, Note1	200	A
P_C	Maximum Power Dissipation		670	W
T_j	junction temperature	-	-40 to 150	$^{\circ}\text{C}$
T_{stg}	Storage temperature	-	-40 to 125	$^{\circ}\text{C}$

Note1: Pulse width limited by maximum junction temperature

Maximum Ratings (Freewheeling diode, $T_j=25^{\circ}\text{C}$ unless otherwise specified)

Symbol	Parameter	Conditions	Ratings	Unit
V_{RRM}	Peak Repetitive Revers Voltage	-	1200	V
I_F	Diode forward Current	-	100	A
I_{FRM}	Repetitive peak forward Current	$t_p=1\text{ms}$, Note1	200	A
T_j	junction temperature	-	-40 to 150	$^{\circ}\text{C}$
T_{stg}	Storage temperature	-	-40 to 125	$^{\circ}\text{C}$

Note1: Pulse width limited by maximum junction temperature

Maximum Ratings (IGBT, Brake-chopper, $T_j=25^{\circ}\text{C}$ unless otherwise specified)

Symbol	Parameter	Conditions	Ratings	Unit
V_{CES}	Collector-Emitter Voltage	G-E Short	1200	V
V_{RRM}	Peak Repetitive Revers Voltage	-	1200	V
V_{GES}	Gate-Emitter Voltage	C-E Short	$\pm 30\text{V}$	V
I_C	DC Continuous Collector Current	$T_C=100^{\circ}\text{C}$	50	A
I_{CM}	Pulse Collector Current	$t_p=1\text{ms}$, Note1	100	A
P_C	Maximum Power Dissipation		365	W
T_j	junction temperature	-	-40 to 150	$^{\circ}\text{C}$
T_{stg}	Storage temperature	-	-40 to 125	$^{\circ}\text{C}$

Note1: Pulse width limited by maximum junction temperature

Maximum Ratings (diode, Brake-chopper, $T_j=25^{\circ}\text{C}$ unless otherwise specified)

Symbol	Parameter	Conditions	Ratings	Unit
V_{RRM}	Peak Repetitive Revers Voltage	-	1200	V
I_F	Diode forward Current	-	50	A
I_{FRM}	Repetitive peak forward Current	$t_p=1\text{ms}$, Note1	100	A
T_j	junction temperature	-	-40 to 150	$^{\circ}\text{C}$
T_{stg}	Storage temperature	-	-40 to 125	$^{\circ}\text{C}$

Note1: Pulse width limited by maximum junction temperature

NTC characteristics

Symbol	Parameter	Condition	Value			Unit
			Min.	Typ.	Max.	
R ₂₅	Resistance	T _C = 25°C	-	5	-	kΩ
ΔR/R	Deviation of R100	T _C = 100°C, R ₁₀₀ = 493Ω	-5	-	5	%
P ₂₅	Power dissipation	T _C = 25°C	-	-	20	mW
B _{25/50}	B-value	R ₂ = R ₂₅ exp [B _{25/50} (1/T ₂ - 1/(298,15 K))]	-	3375	-	K
B _{25/80}	B-value	R ₂ = R ₂₅ exp [B _{25/80} (1/T ₂ - 1/(298,15 K))]	-	3410	-	K
B _{25/100}	B-value	R ₂ = R ₂₅ exp [B _{25/100} (1/T ₂ - 1/(298,15 K))]	-	3433	-	K

IGBT Electrical characteristics (T_j = 25°C unless otherwise specified, chip)

Symbol	Item	Condition	Value			Unit		
			Min.	Typ.	Max.			
V _{CE(sat)} (Chip)	Collector-Emitter Saturation	I _C = 100A	T _j = 25°C	-	2.1	2.3	V	
	Voltage	V _{GE} = 15V	T _j = 125°C	-	2.5	-	V	
V _{GE(th)}	Gate-Emitter threshold Voltage	I _C = 1mA, V _{CE} = V _{GE}		4.5	-	5.5	V	
Q _G	Gate charge	V _{GE} = -15V to +15V		-	1000	-	nC	
R _{Gint}	Internal gate resistor	f = 1M, V _{pp} = 1V	T _j = 25°C	-	1.9	-	Ω	
C _{ies}	Input Capacitance	V _{CE} = 25V, V _{GE} = 0V	T _j = 25°C	-	8.00	-	nF	
C _{oes}	Output Capacitance	f = 1MHz		-	1.35	-	nF	
C _{res}	Reverse transfer Capacitance			-	0.81	-	nF	
I _{CES}	Collector- Emitter Cut off Current	V _{CE} = 1200V, V _{GE} = 0V	T _j = 25°C	-	-	1	mA	
I _{GES}	Gate-Emitter Leakage Current	V _{GE} = 30V, V _{CE} = 0V	T _j = 25°C	-	-	200	nA	
t _{d(on)}	Turn-on delay time	V _{CC} = 600V I _C = 100A V _{GE} = +15V/-15V R _G = 5.6Ω Inductive load	T _j = 25°C	-	90	-	ns	
			T _j = 125°C	-	100	-	ns	
t _r	Rise time		T _j = 25°C	-	60	-	ns	
			T _j = 125°C	-	65	-	ns	
t _{d(off)}	Turn-off delay time		T _j = 25°C	-	460	-	ns	
			T _j = 125°C	-	470	-	ns	
t _f	Fall time		T _j = 25°C	-	220	-	ns	
			T _j = 125°C	-	300	-	ns	
E _{on}	Turn-on power dissipation		T _j = 25°C	-	5.3	-	mJ	
			T _j = 125°C	-	5.8	-	mJ	
E _{off}	Turn-off power dissipation		T _j = 25°C	-	7.1	-	mJ	
			T _j = 125°C	-	9.0	-	mJ	
R _{th(j-c)}	Thermal Resistance, Junction to Case (IGBT)				-		-0.186	°C/W

Freewheeling Diode Electrical characteristics ($T_j=25^\circ\text{C}$ unless otherwise specified, chip)

Symbol	Item	Condition		Value			Unit	
				Min.	Typ.	Max		
V_F	Diode Forward Voltage	$I_F=100\text{A}, V_{GE}=0\text{V}$	$T_j=25^\circ\text{C}$	-	1.90	2.2	V	
			$T_j=125^\circ\text{C}$	-	1.9	-		
t_{rr}	Reverse recovery time	(Switch side) $V_{rr}=600\text{V}, I_F=100\text{A}$ $di/dt=1500\text{A}/\mu\text{s}$	$T_j=25^\circ\text{C}$	-	120	-	ns	
			$T_j=125^\circ\text{C}$	-	145	-		
I_{rr}	Peak reverse recovery Current		$T_j=25^\circ\text{C}$	-	90	-	A	
			$T_j=125^\circ\text{C}$	-	110	-		
Q_{rr}	Recovered charge		$T_j=25^\circ\text{C}$	-	6.5	-	uC	
			$T_j=125^\circ\text{C}$	-	8.7	-		
E_{rr}	Reverse recovered energy		$T_j=25^\circ\text{C}$	-	1.8	-	mJ	
			$T_j=125^\circ\text{C}$	-	2.5	-		
$R_{th(j-c)}$	Thermal Resistance, Junction to Case (Diode)				-		0.301	$^\circ\text{C}/\text{W}$

IGBT, Brake-chopper Electrical characteristics ($T_j=25^\circ\text{C}$ unless otherwise specified, chip)

Symbol	Item	Condition		Value			Unit
				Min.	Typ.	Max	
$V_{CE(sat)}$ (Chip)	Collector-Emitter Saturation Voltage	$I_C=50\text{A}$	$T_j=25^\circ\text{C}$	-	2.1	2.3	V
		$V_{GE}=15\text{V}$	$T_j=125^\circ\text{C}$	-	2.5	-	V
$V_{GE(th)}$	Gate-Emitter threshold Voltage	$I_C=1\text{mA}, V_{CE}=V_{GE}$		4.5	-	5.7	V
Q_G	Gate charge	$V_{GE}=-15\text{V to }+15\text{V}$		-	430	-	nC
R_{Gint}	Internal gate resistor	$f=1\text{M}, V_{pp}=1\text{V}$	$T_j=25^\circ\text{C}$	-	2.2	-	Ω
C_{ies}	Input Capacitance	$V_{CE}=25\text{V}, V_{GE}=0\text{V}$ $f=1\text{MHz}$	$T_j=25^\circ\text{C}$	-	3.80	-	nF
C_{oes}	Output Capacitance			-	0.51	-	nF
C_{res}	Reverse transfer Capacitance			-	0.33	-	nF
I_{CES}	Collector- Emitter Cut off Current	$V_{CE}=1200\text{V}, V_{GE}=0\text{V}$	$T_j=25^\circ\text{C}$	-	-	1	mA
I_{GES}	Gate-Emitter Leakage Current	$V_{GE}=30\text{V}, V_{CE}=0\text{V}$	$T_j=25^\circ\text{C}$	-	-	200	nA
$t_{d(on)}$	Turn-on delay time	$V_{CC}=600\text{V}$ $I_C=50\text{A}$ $V_{GE}=+15\text{V}/-15\text{V}$ $R_G=5.6\Omega$ Inductive load	$T_j=25^\circ\text{C}$	-	20	-	ns
			$T_j=125^\circ\text{C}$	-	25	-	
t_r	Rise time		$T_j=25^\circ\text{C}$	-	40	-	ns
			$T_j=125^\circ\text{C}$	-	45	-	
$t_{d(off)}$	Turn-off delay time		$T_j=25^\circ\text{C}$	-	300	-	ns
			$T_j=125^\circ\text{C}$	-	330	-	
t_f	Fall time		$T_j=25^\circ\text{C}$	-	160	-	ns
			$T_j=125^\circ\text{C}$	-	180	-	
E_{on}	Turn-on power dissipation		$T_j=25^\circ\text{C}$	-	4.5	-	mJ
			$T_j=125^\circ\text{C}$	-	6.5	-	
E_{off}	Turn-off power dissipation	$T_j=25^\circ\text{C}$	-	4.2	-	mJ	

			$T_j=125^{\circ}\text{C}$	-	6.1	-	
$R_{th(j-c)}$	Thermal Resistance, Junction to Case (IGBT)			-		0.343	$^{\circ}\text{C/W}$

Diode, Brake-chopper Electrical characteristics ($T_j=25^{\circ}\text{C}$ unless otherwise specified, chip)

Symbol	Item	Condition	Value			Unit	
			Min.	Typ.	Max		
V_F	Diode Forward Voltage	$I_F=50\text{A}, V_{GE}=0\text{V}$	$T_j=25^{\circ}\text{C}$	-	1.90	2.2	V
			$T_j=125^{\circ}\text{C}$	-	1.9	-	
t_{rr}	Reverse recovery time		$T_j=25^{\circ}\text{C}$	-	110	-	ns
			$T_j=125^{\circ}\text{C}$	-	250	-	
I_{rr}	Peak reverse recovery Current	(Switch side) $V_{rr}=600\text{V}, I_F=50\text{A}$	$T_j=25^{\circ}\text{C}$	-	85	-	A
			$T_j=125^{\circ}\text{C}$	-	100	-	
Q_{rr}	Recovered charge	$di/dt=1500\text{A}/\mu\text{s}$	$T_j=25^{\circ}\text{C}$	-	5.5	-	μC
			$T_j=125^{\circ}\text{C}$	-	9.5	-	
E_{rr}	Reverse recovered energy		$T_j=25^{\circ}\text{C}$	-	1.8	-	mJ
			$T_j=125^{\circ}\text{C}$	-	3.7	-	
$R_{th(j-c)}$	Thermal Resistance, Junction to Case (Diode)			-		0.652	$^{\circ}\text{C/W}$

Maximum Ratings (Rectifier diode, $T_j=25^{\circ}\text{C}$ unless otherwise specified)

Symbol	Parameter	Conditions	Ratings	Unit
V_{RRM}	Peak Repetitive Revers Voltage	$T_j=25^{\circ}\text{C}$	1800	V
I_{FRMSM}	Maximum RMS forward current per chip	$T_c=80^{\circ}\text{C}$	100	A
I_{RMSM}	Maximum RMS current at rectifier output	$T_c=80^{\circ}\text{C}$	200	A
I_{FSM}	Surge Current @ $t_p=10\text{ms}$	$T_j=25^{\circ}\text{C}$	1080	A
I^2t	I^2t - value	$T_j=25^{\circ}\text{C}$	5832	A^2s
T_j	junction temperature	-	-40 to 150	$^{\circ}\text{C}$
T_{stg}	Storage temperature	-	-40 to 125	$^{\circ}\text{C}$

Note1: Pulse width limited by maximum junction temperature

Rectifier Diode Electrical characteristics ($T_j=25^{\circ}\text{C}$ unless otherwise specified, chip)

Symbol	Item	Condition	Value			Unit
			Min.	Typ.	Max	
V_F	Diode Forward Voltage	$I_F=100\text{A}$	$T_j=25^{\circ}\text{C}$		1.05	V
			$T_j=125^{\circ}\text{C}$		0.85	
I_R	Reverse current		$T_j=125^{\circ}\text{C}$		1.0	mA
$R_{\theta JC}$	Thermal Resistance, Junction-to-Case (Diode)				0.40	$^{\circ}\text{C/W}$

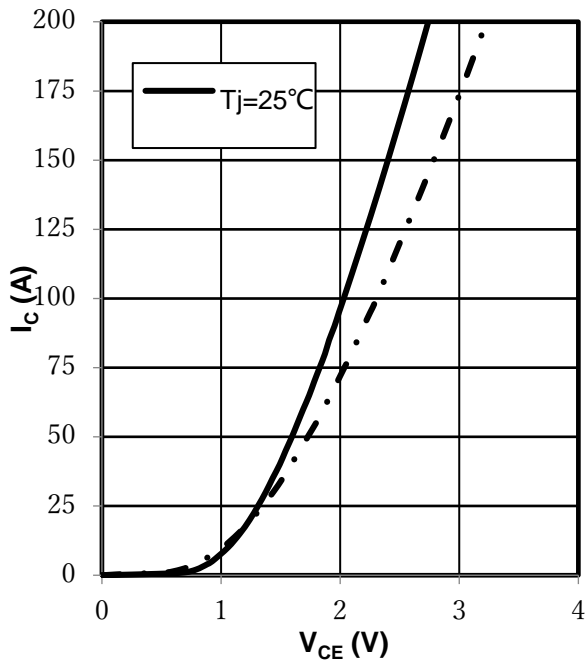

Fig 1. output characteristic IGBT,
 $I_c=f(V_{CE}), V_{GE}=15V$

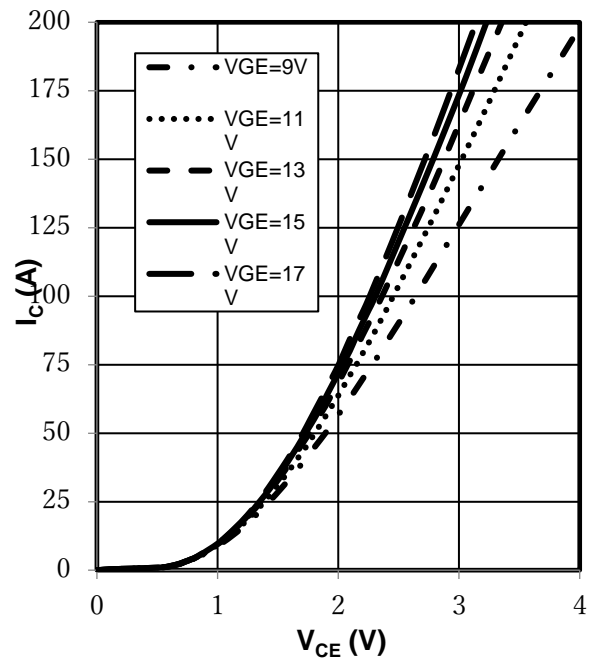

Fig 2. output characteristic IGBT,
 $I_c=f(V_{CE}), T_j=125^\circ C$

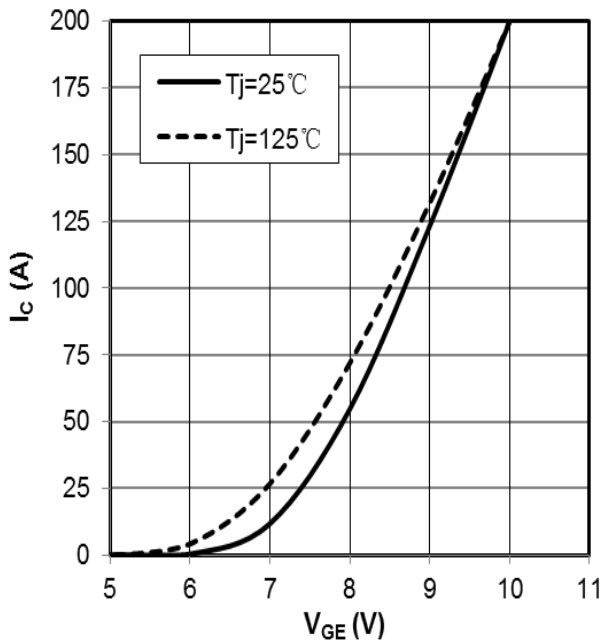

Fig 3. transfer characteristic IGBT,
 $I_c=f(V_{GE}), V_{CE}=20V$

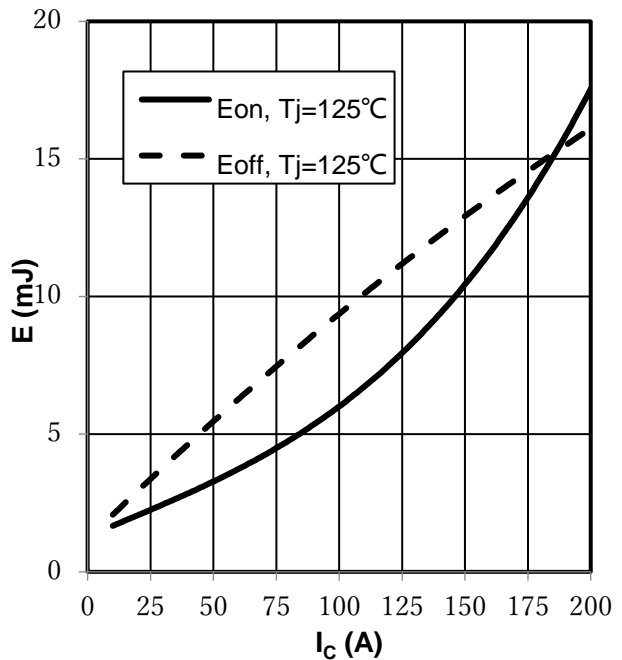

Fig 4. switching losses IGBT,
 $E_{on}=f(I_c), E_{off}=f(I_c)$

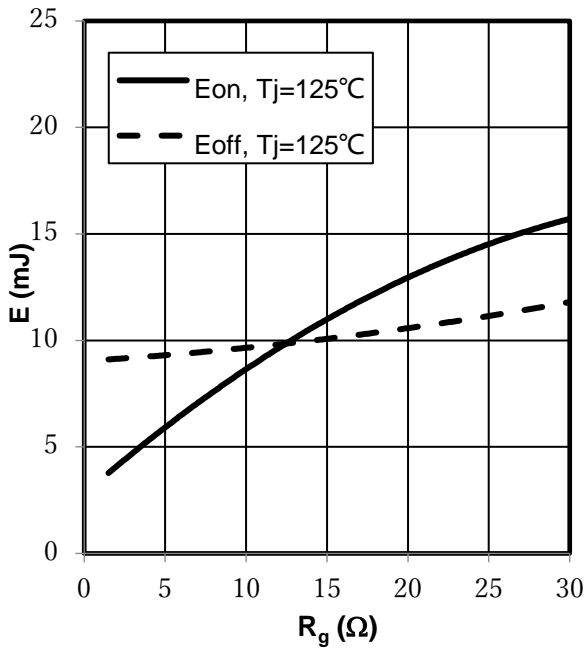

Fig 5. switching losses IGBT, $E_{on}=f(R_g), E_{off}=f(R_g)$,
 $V_{GE}=\pm 15\text{V}, I_c=100\text{A}, V_{CE}=600\text{V}$

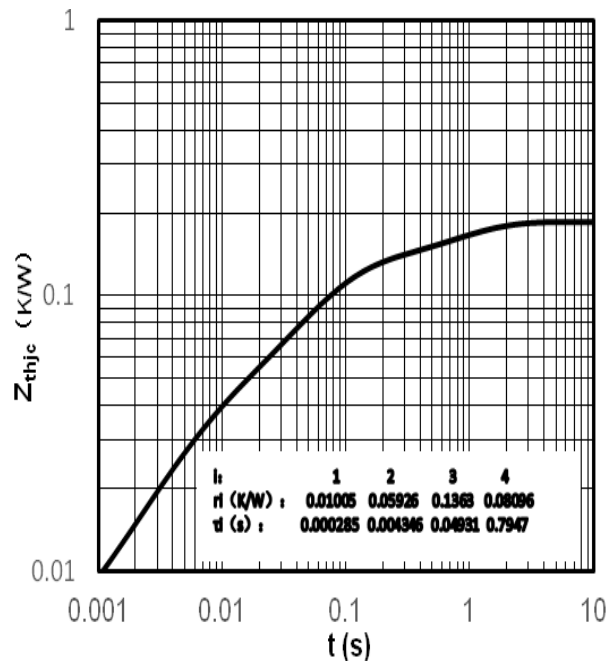

Fig 6. transient thermal impedance IGBT ,
 $Z_{thjc}=f(t)$

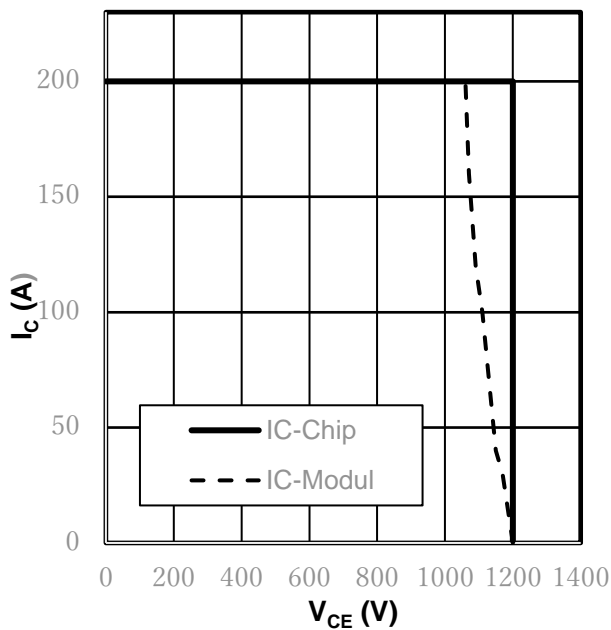

Fig 7. reverse bias safe operating area IGBT,
 $I_c=f(V_{CE}), V_{GE}=\pm 15\text{V}, R_{Goff}=5.6\Omega, T_{vj}=125^\circ\text{C}$

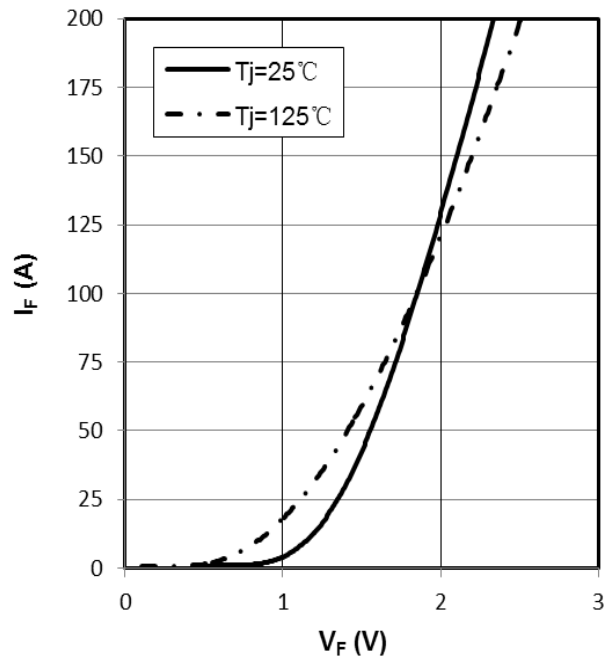

Fig 8. forward characteristic of Diode ,
 $I_F=f(V_F)$

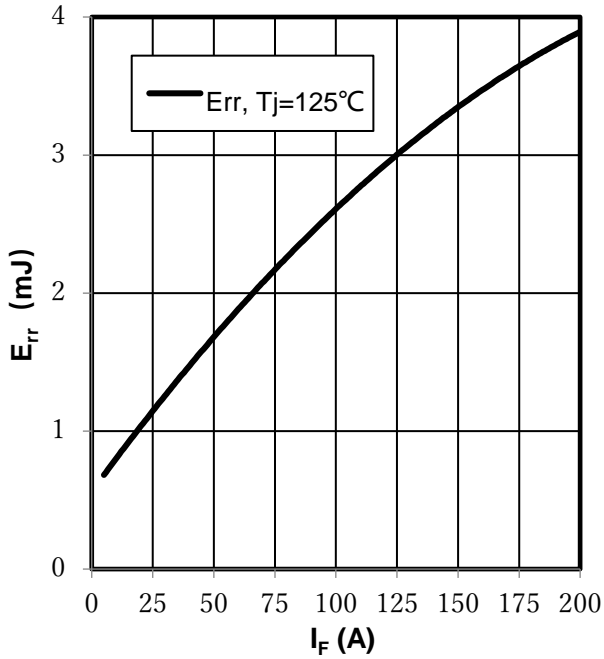

Fig9. switching losses Diode,
 $E_{rr}=f(I_F), R_{Gon}=5.6\Omega, V_{CE}=600V$

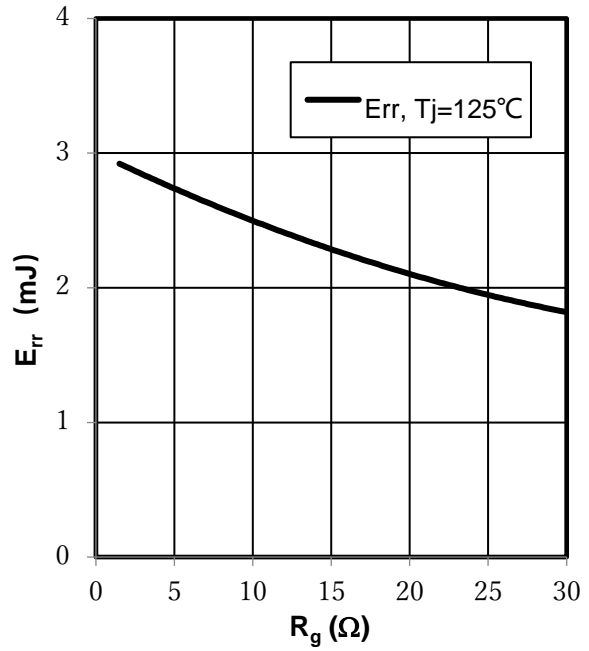

Fig 10. switching losses Diode,
 $E_{rr}=f(R_g), I_F=100A, V_{CE}=600V$

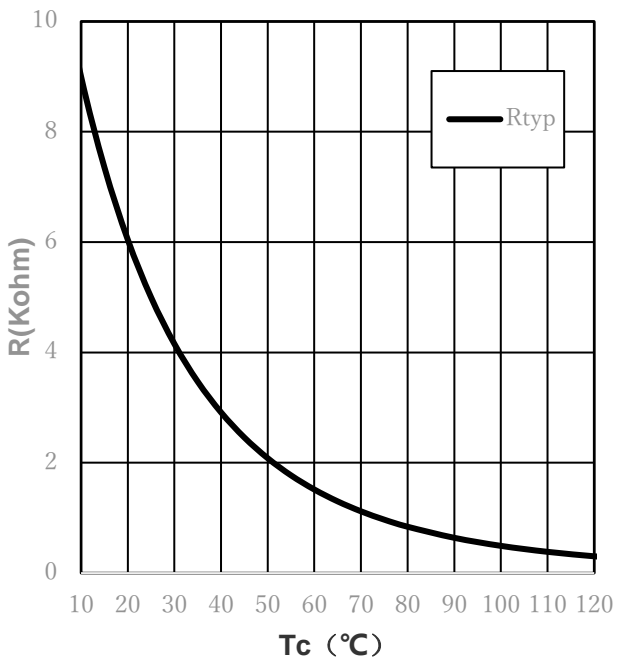

Fig11.NTC-Thermistor-temperature characteristic(typical)

IMPORTANT NOTICE:

This product data sheet describes the characteristics of this product for which a warranty is granted. Any such warranty is granted exclusively under the terms and conditions of the supply agreement. There will be no guarantee or of any kind for the product and its characteristics.

The data contained in this document is exclusively intended for technically trained staff. You and your technical departments will have to evaluate the product's suitability for the intended application and the completeness of the product data concerning such application.

Due to technical requirements, our product may contain dangerous substances. For information on the types in question, please contact the sales staff responsible for you.

Changes to this product data sheet are reserved.

Please contact the sales staff (Sales@leapers-power.com) for further information on the product, technology, delivery terms, conditions and prices.