

Description

The DFS300X2CU12I3B2 is a dual chopper SiC MOSFET Power Module. It integrates high performance SiC MOSFET chips designed for the applications such as Converter and Renewable energy.

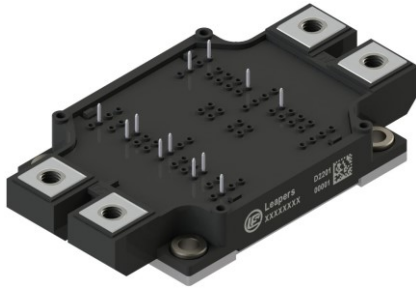

Features

- 1200V/4.5mΩ
- Low thermal resistance with Si₃N₄ AMB
- 175°C maximum junction temperature
- Low Inductive Design
- Thermistor inside
- Copper base size: 79mm*62mm

Applications

- xEV Applications
- Converter
- Vehicle Fast Chargers
- Renewable energy

Circuit diagram

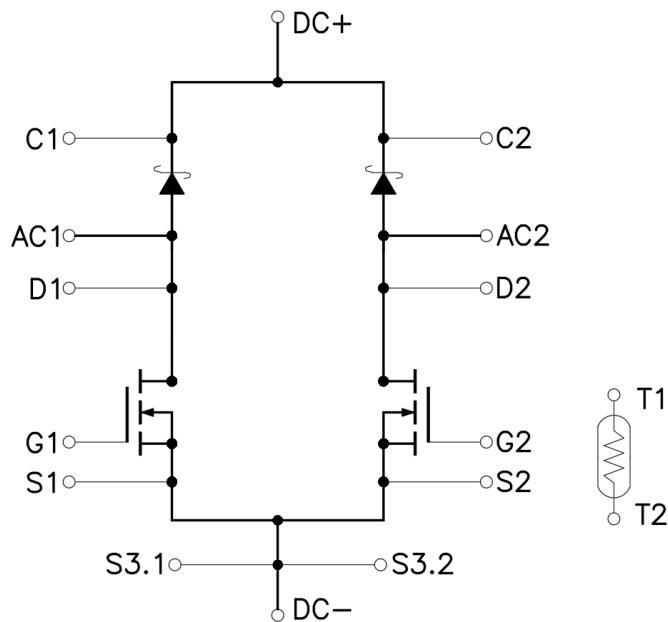

Figure 1. Out drawing & circuit diagram for DFS300X2CU12I3B2

Pin Configuration and Marking Information

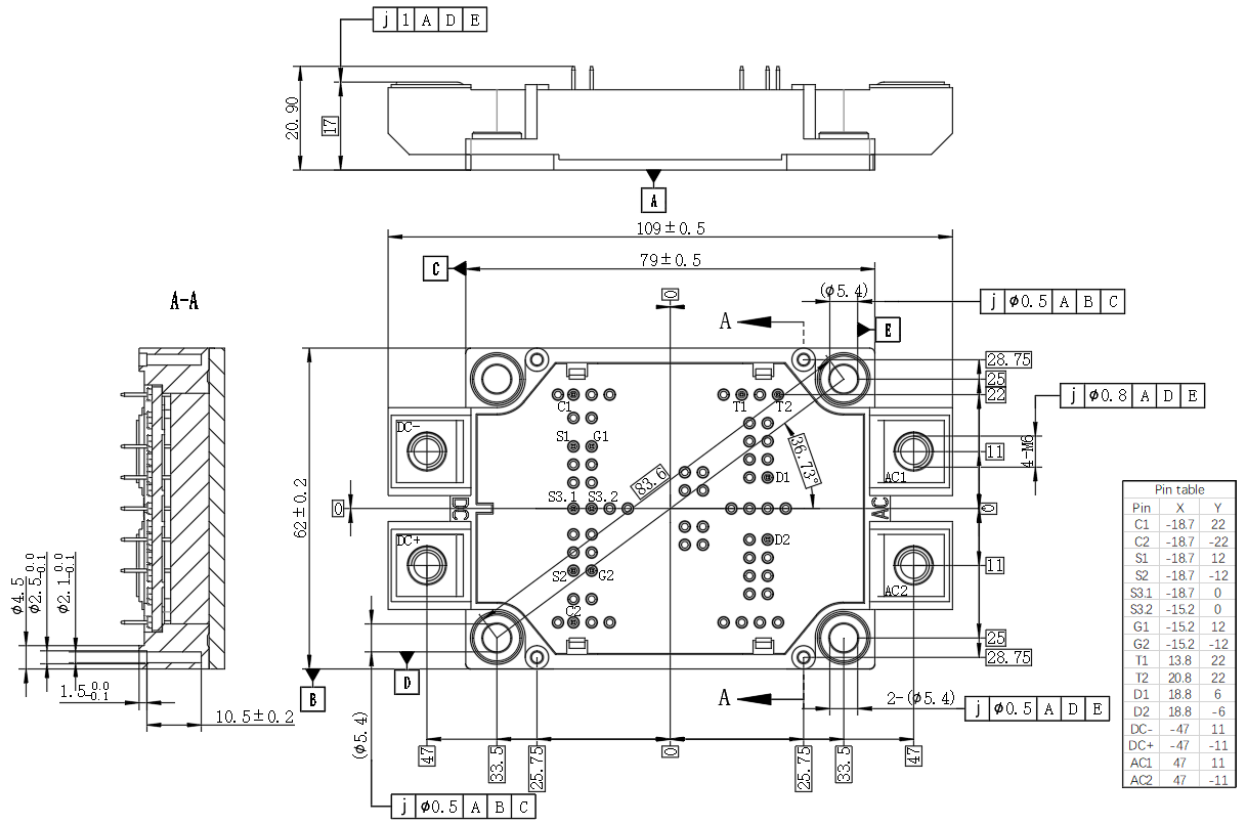

Figure 2. Pin configuration

Module

Parameter	Conditions	Value	Unit
Isolation Voltage	RMS, f = 50Hz, t = 1min	3.4	KV
Material of module baseplate	-	Cu	-
Creepage distance	terminal to heatsink terminal to terminal	14.5 10	mm
Clearance	terminal to heatsink terminal to terminal	12.5 10	mm
CTI	-	>400	-
Module lead resistance, terminals – chip	T _c = 25°C	0.3	mΩ
Mounting torque for module mounting	M5, M6	3 to 6	Nm
Weight	-	250	g

Maximum Ratings (T_j = 25°C unless otherwise specified)

Symbol	Parameter	Conditions	Ratings	Unit
V _{DSS}	Drain-Source Voltage	G-S Short	1200	V
V _{RRM}	Repetitive Reverse Voltage	Clamp Diode	1200	V
V _{GSS}	Gate-Source Voltage	D-S Short, AC frequency ≥ 1Hz, Note1	-11 to 23	V
I _{DS}	DC Continuous Drain Current	T _c = 25°C, V _{GS} = 18V	295	A
I _{DS}	DC Continuous Drain Current	T _c = 65°C, V _{GS} = 18V	255	A
I _{DSM}	Pulse Drain Current	T _c = 65°C, Pulse width = 1ms, V _{GS} = 18V, Note2	600	A
I _F	Forward Current (Diode)	T _c = 25°C	210	A
I _F	Forward Current (Diode)	T _c = 65°C	170	A
I _{FRM}	Pulse Forward Current (Diode)	T _c = 65°C, Pulse width = 1ms, Note2	600	A
P _{tot(MOS)}	Total Power Dissipation (MOS)	T _c = 25°C	937	W
P _{tot(SBD)}	Total Power Dissipation (SBD)	T _c = 25°C	715	W
T _{jmax}	Max Junction Temperature	-	175	°C
T _{jop}	Operating junction Temperature	-	-40 to 150	°C
T _{stg}	Storage Temperature	-	-40 to 125	°C

Note1: Recommended Operating Value, -4V/+15V, -5V/+18V

Note2: Pulse width limited by maximum junction temperature

NTC characteristics

Symbol	Parameter	Condition	Value			Unit
			Min.	Typ.	Max.	
R ₂₅	Resistance	T _c = 25°C	-	5	-	kΩ
ΔR/R	Deviation of R100	T _c = 100°C, R ₁₀₀ = 493Ω	5	-	5	%
P ₂₅	Power dissipation	T _c = 25°C	-	-	20	mW
B _{25/50}	B-value	R ₂ = R ₂₅ exp [B _{25/50} (1/T ₂ - 1/(298,15 K))]	-	3375	-	K
B _{25/80}	B-value	R ₂ = R ₂₅ exp [B _{25/80} (1/T ₂ - 1/(298,15 K))]	-	3411	-	K
B _{25/100}	B-value	R ₂ = R ₂₅ exp [B _{25/100} (1/T ₂ - 1/(298,15 K))]	-	3433	-	K

MOSFET Electrical characteristics (T_j=25°C unless otherwise specified, chip)

Symbol	Item	Condition	Value			Unit	
			Min.	Typ.	Max		
V _{(BR)DSS}	Drain-Source Breakdown Voltage	V _{GS} =0V, I _D =3mA	1200	-	-	V	
I _{DSS}	Zero gate voltage drain Current	V _{DS} =1200V, V _{GS} =0V	-	-	30	μA	
V _{GS(th)}	Gate-source threshold Voltage	I _D =30mA, V _{DS} =V _{GS}	T _j =25°C	2.1	3.2	5.8	V
I _{GSS}	Gate-Source Leakage Current	V _{GS} =20V, V _{DS} =0V	T _j =25°C	-	-	60	nA
R _{DS(on)} (Chip)	Static drain-source	I _D =300A V _{GS} =18V	T _j =25°C	2.9	4.5	6	mΩ
	On-state resistance		T _j =175°C	6.9	10.7	14.4	mΩ
V _{DS(on)} (Chip)	Static drain-source	I _D =300A V _{GS} =18V	T _j =25°C	0.87	1.35	1.80	V
	On-state Voltage		T _j =175°C	2.07	3.21	4.32	V
C _{iss}	Input Capacitance	V _D =850V, V _{GS} =0V, f =100kHz	-	12	-	nF	
C _{oss}	Output Capacitance		-	0.69	-	nF	
C _{rss}	Reverse transfer Capacitance		-	0.066	-	nF	
Q _g	Total gate charge	V _{DD} =850V, I _D =300A, V _{GS} =-5/+18V	-	540	-	nC	
t _{d(on)}	Turn-on delay time	V _{DD} =600V I _D =300A V _{GS} =+15/-4V R _{G(on)} =5.1Ω R _{G(off)} =3.3Ω Inductive load switching operation	T _j =25°C	-	90	-	ns
			T _j =150°C	-	79	-	ns
t _r	Rise time		T _j =25°C	-	70	-	ns
			T _j =150°C	-	65	-	ns
t _{d(off)}	Turn-off delay time		T _j =25°C	-	198	-	ns
			T _j =150°C	-	201	-	ns
t _f	Fall time		T _j =25°C	-	39	-	ns
			T _j =150°C	-	41	-	ns
E _{on}	Turn-on power dissipation		T _j =25°C	-	5.86	-	mJ
			T _j =150°C	-	5.82	-	mJ
E _{off}	Turn-off power dissipation	T _j =25°C	-	3.64	-	mJ	
		T _j =150°C	-	3.83	-	mJ	
R _{th(j-c)}	FET Thermal Resistance	Junction to Case	-	0.16	-	K/W	
R _{th(c-f)}	Contact thermal Resistance	With thermal conductive grease, Note3	-	0.015	-	K/W	

Note3: Assumes Thermal Conductivity of grease is 0.9W/m·K and thickness is 50um.

SiC SBD Electrical characteristics ($T_j=25^\circ\text{C}$ unless otherwise specified, chip)

Symbol	Item	Condition	Value			Unit	
			Min.	Typ.	Max		
I_{RRM}	Reverse Current	$V_{RRM}=1200\text{V}$	-	-	200	μA	
V_F	Forward Voltage	$I_F=200\text{A}$	$T_j=25^\circ\text{C}$	-	2.1	2.6	V
			$T_j=175^\circ\text{C}$	-	3.8	-	
T_{rr}	Reverse recovery time	$V_{RR}=600\text{V}, I_F=200\text{A}$ MOSFET side:	$T_j=25^\circ\text{C}$	-	30	-	ns
			$T_j=150^\circ\text{C}$	-	32	-	
Q_{rr}	Reverse recovery charge	$V_{GS}=+15/-4\text{V}$ $R_{G(on)}=5.1\Omega, R_{G(off)}=3.3\Omega$	$T_j=25^\circ\text{C}$	-	0.74	-	μC
			$T_j=150^\circ\text{C}$	-	0.83	-	
E_{rr}	Diode switching power dissipation	Inductive load switching operation	$T_j=25^\circ\text{C}$	-	0.14	-	mJ
			$T_j=150^\circ\text{C}$	-	0.23	-	
$R_{th(j-c)}$	SiC SBD Thermal Resistance	Junction to Case	-	0.21	-	K/W	
$R_{th(c-f)}$	Contact thermal Resistance	With thermal conductive grease, Note4	-	0.015	-	K/W	

Note4: Assumes Thermal Conductivity of grease is $0.9\text{W/m}\cdot\text{K}$ and thickness is $50\mu\text{m}$.

Test Conditions

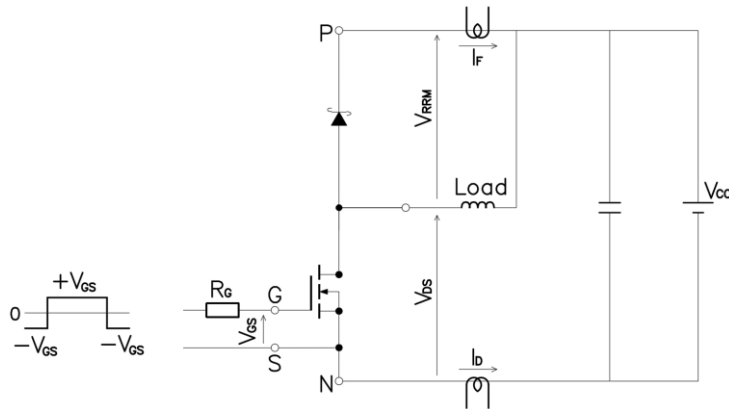

Figure 3. Switching time measure circuit

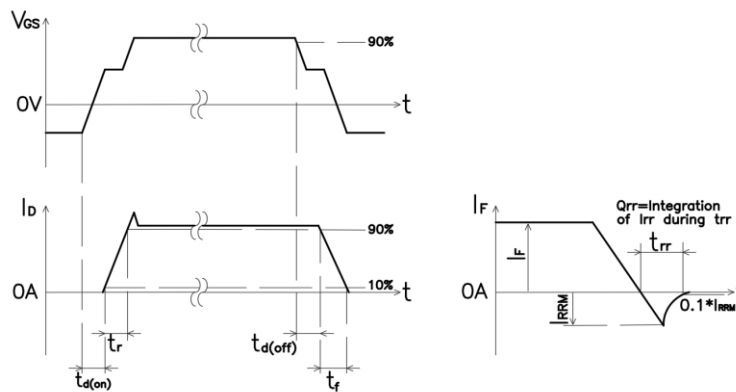

Figure 4. Switching time definition

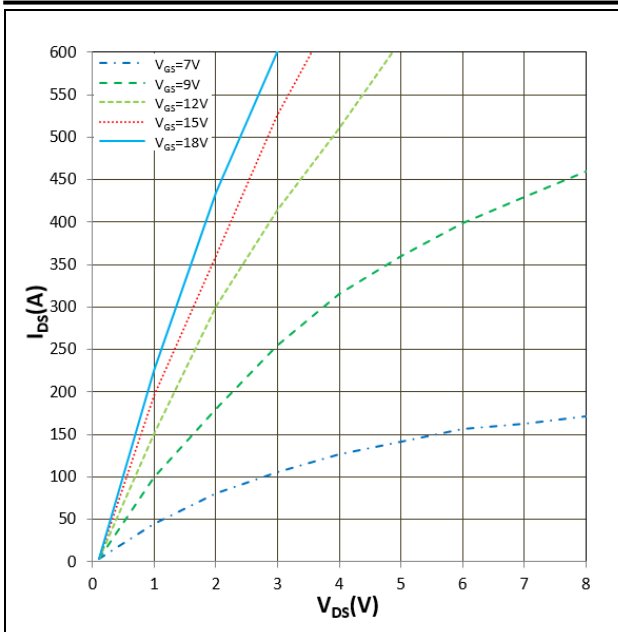

Figure 5. I_{DS} vs V_{DS}
 $T_j = 25^\circ\text{C}$

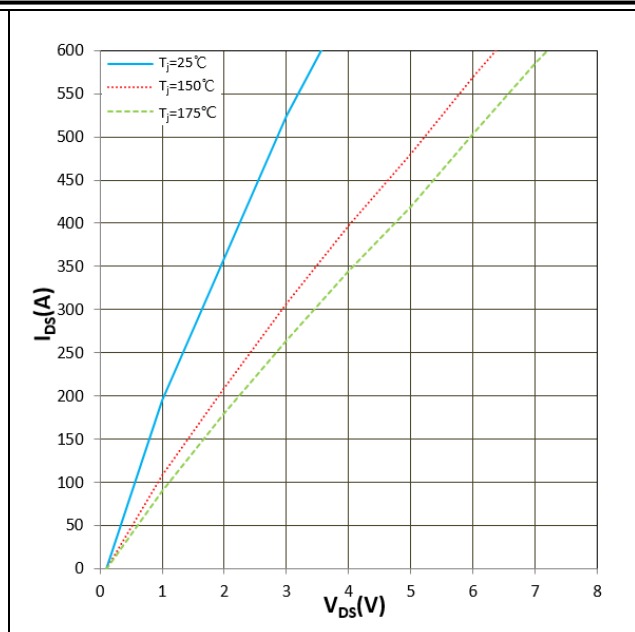

Figure 6. I_{DS} vs V_{DS}
 $V_{GS} = 15\text{V}$

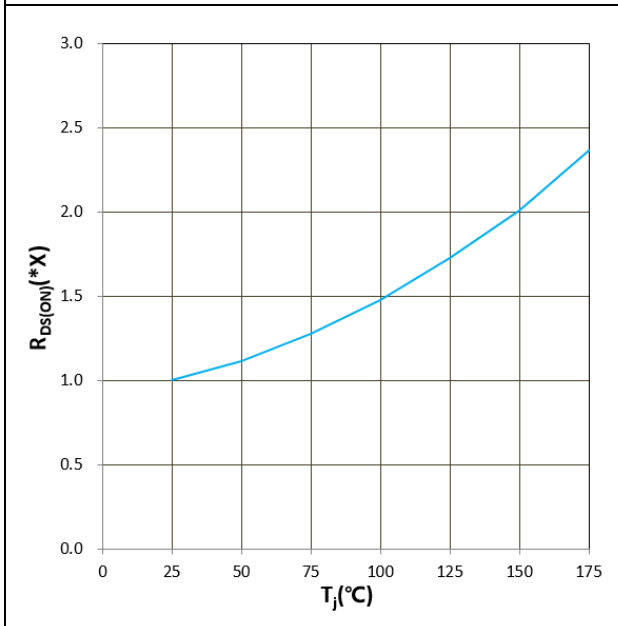

Figure 7. $R_{DS(ON)}$ vs T_j
 $V_{GS} = +18\text{V}$, $I_D = 300\text{A}$, $1.0X = 4.5\text{m}\Omega$

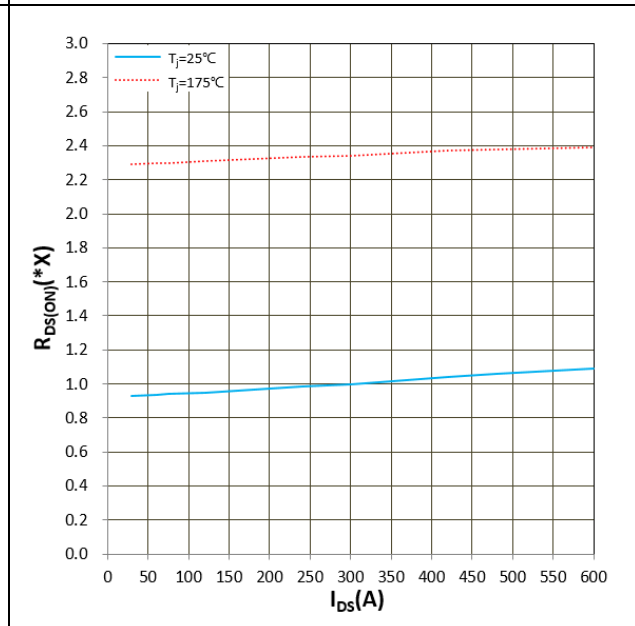

Figure 8. $R_{DS(ON)}$ vs I_{DS}
 $V_{GS} = +18\text{V}$, $I_D = 300\text{A}$, $1.0X = 4.5\text{m}\Omega$

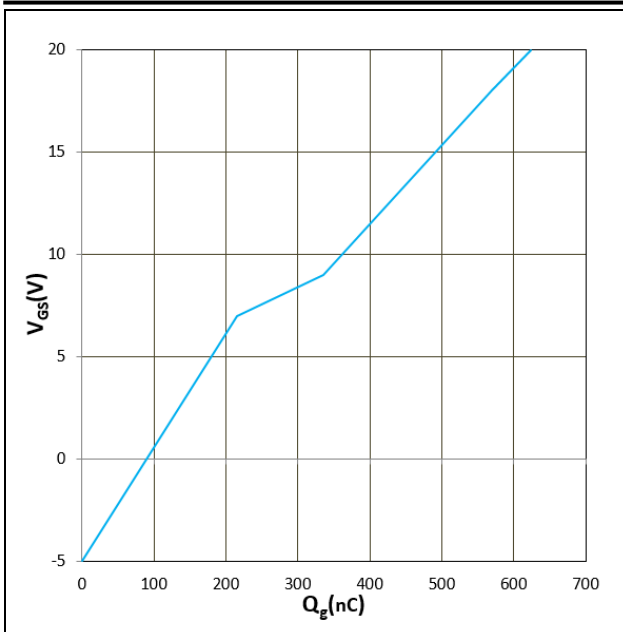

Figure 9. V_{GS} vs Q_g
 $T_j = 25^\circ\text{C}$, $I_{GS} = 3\text{mA}$

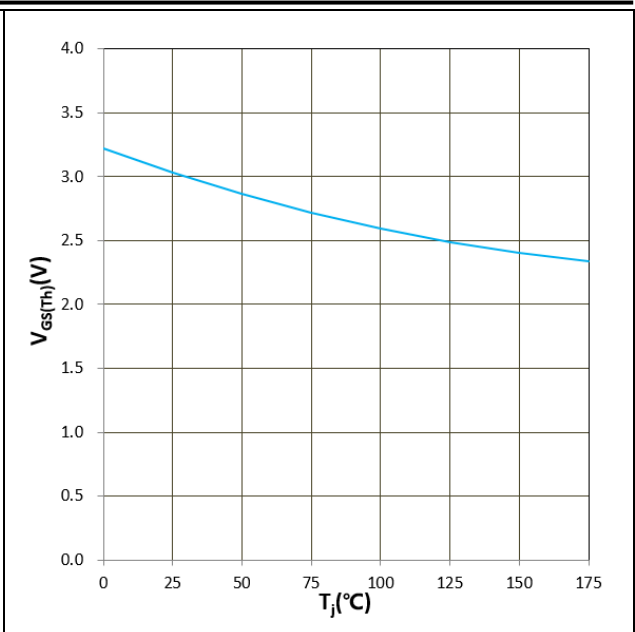

Figure 10. $V_{GS(TH)}$ vs T_j
 $V_{GS} = V_{DS}$, $I_D = 30\text{mA}$

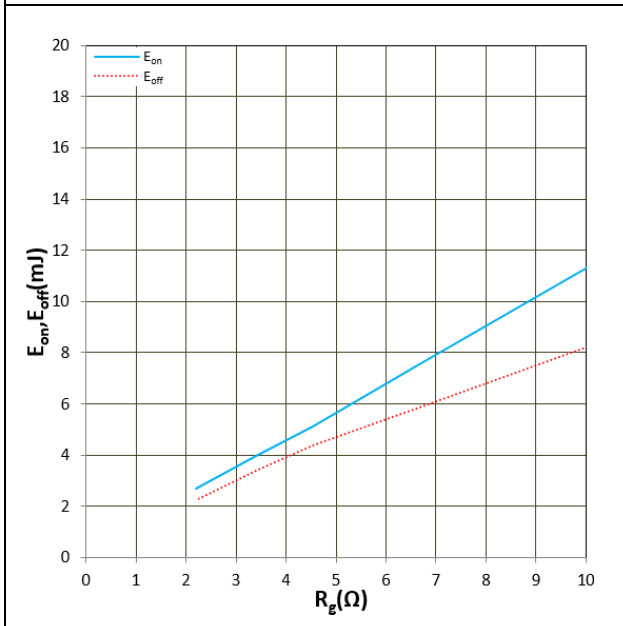

Figure 11. E_{on} , E_{off} vs R_g
 $T_j = 25^\circ\text{C}$, $V_{CC} = 600\text{V}$, $V_{GS} = +15\text{V}/-4\text{V}$, $I_D = 300\text{A}$
 Inductive Load

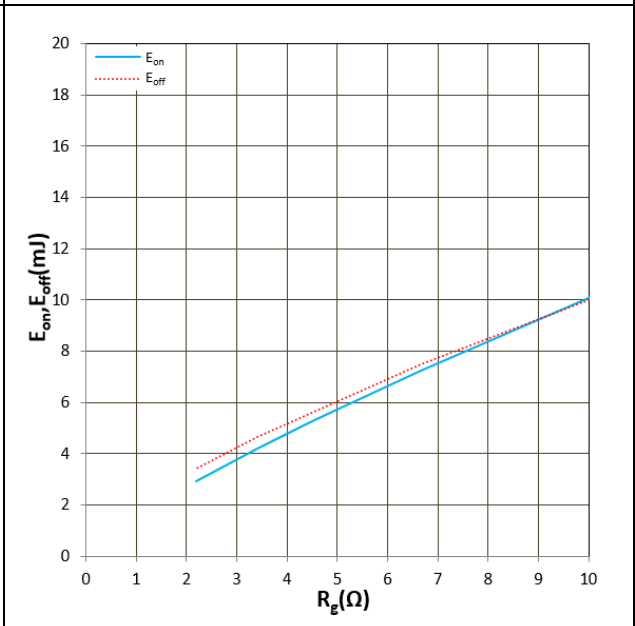

Figure 12. E_{on} , E_{off} vs R_g
 $T_j = 150^\circ\text{C}$, $V_{CC} = 600\text{V}$, $V_{GS} = +15\text{V}/-4\text{V}$, $I_D = 300\text{A}$
 Inductive Load

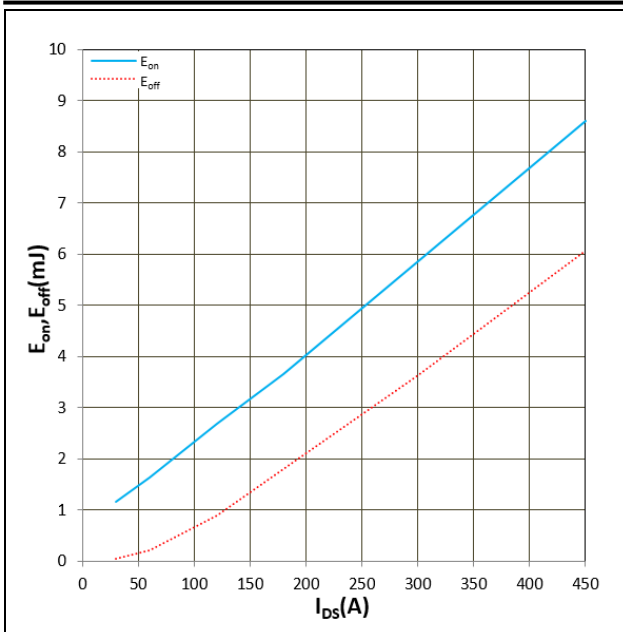

Figure 13. E_{on} , E_{off} vs I_{DS}
 $T_j=25^\circ\text{C}$, $V_{CC}=600\text{V}$, $V_{GS}=+15\text{V}/-4\text{V}$
 $R_{G(on)}=5.1\Omega$, $R_{G(off)}=3.3\Omega$, Inductive Load

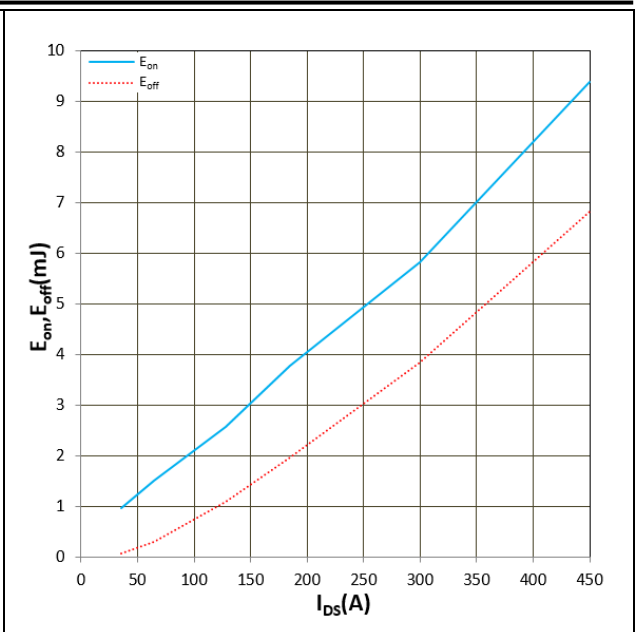

Figure 14. E_{on} , E_{off} vs I_{DS}
 $T_j=150^\circ\text{C}$, $V_{CC}=600\text{V}$, $V_{GS}=+15\text{V}/-4\text{V}$
 $R_{G(on)}=5.1\Omega$, $R_{G(off)}=3.3\Omega$, Inductive Load

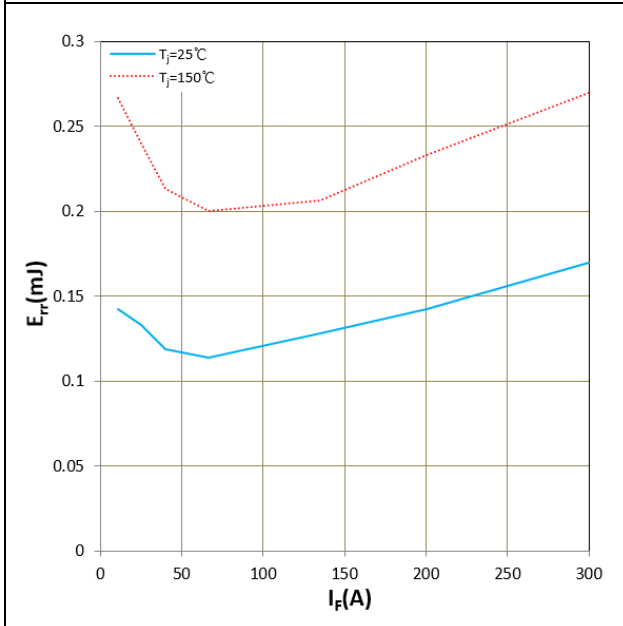

Figure 15. E_{rr} vs I_F
 $V_{CC}=600\text{V}$, $V_{GS}=+15\text{V}/-4\text{V}$
 $R_{G(on)}=5.1\Omega$, $R_{G(off)}=3.3\Omega$, Inductive Load

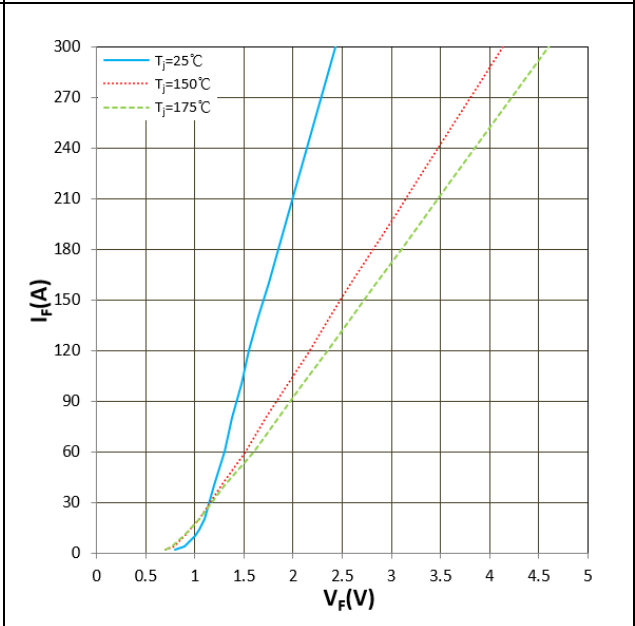

Figure 16. I_F vs V_F

IMPORTANT NOTICE:

This product data sheet describes the characteristics of this product for which a warranty is granted. Any such warranty is granted exclusively under the terms and conditions of the supply agreement. There will be no guarantee or of any kind for the product and its characteristics.

The data contained in this document is exclusively intended for technically trained staff. You and your technical departments will have to evaluate the product's suitability for the intended application and the completeness of the product data concerning such application.

Due to technical requirements, our product may contain dangerous substances. For information on the types in question, please contact the sales staff responsible for you.

Changes to this product data sheet are reserved.

Please contact the sales staff (Sales@leapers-power.com) for further information on the product, technology, delivery terms, conditions and prices.