

DETAILS

Product Number	CA12087_STRADA-FW
Family	Strada
Type	Assembly
Color	clear
Diameter	19,6 x 15,5 mm
Height	10,8 mm
Style	rectang
Optic Material	PMMA
Holder Material	
Fastening	tape, pin, screw
Status	production ready
ROHS Compliant	Yes
Date Updated	10/05/2017



OPTICAL PROPERTIES

LED	Viewing Angle	Light Beam	Efficiency	cd/lm	Connector
XP-E	Asymmetric deg	Asymmetric	92 %	-	-
XP-G	Asymmetric deg	Asymmetric	92 %	-	-
XM-L	Asymmetric deg	Asymmetric	92 %	-	-
XT-E	Asymmetric deg	Asymmetric	sim: 90 %	-	-
XM-L2	asymmetric deg	Asymmetric	94 %	0.700	-
XP-G2	asymmetric deg	Asymmetric	93 %	0.900	-
XP-L	Asymmetric deg	Asymmetric	93 %	0.670	-
XP-L2	Asymmetric deg	Asymmetric	92 %	0.590	-
H35C0 (LEMWA33)	Asymmetric deg	Asymmetric	sim: 88 %	0.880	-
H35B0 (LEMWA32)	Asymmetric deg	Asymmetric	91 %	1.000	-
LUXEON Rebel	Asymmetric deg	Asymmetric	92 %	-	-
LUXEON Rebel ES	Asymmetric deg	Asymmetric	92 %	-	-
LUXEON Z ES	Asymmetric deg	Asymmetric	91 %	0.970	-
LUXEON T	asymmetric deg	Asymmetric	91 %	0.841	-
LUXEON TX	Asymmetric deg	Asymmetric	93 %	0.830	-
NCSxx19A	Asymmetric deg	Asymmetric	92 %	-	-
NVSxx19A	Asymmetric deg	Asymmetric	92 %	-	-
NVSxx19B/NVSxx19C	sim: Asym	Asymmetric	sim: 89 %	sim: 0.836	-
Oslon SSL 80	Asymmetric deg	Asymmetric	92 %	-	-
Oslon SSL 150	Asymmetric deg	Asymmetric	92 %	-	-
Fortimo FastFlex LED board 2x8/757 DS	Asymmetric deg	Asymmetric	90 %	0.920	-
LH351Z	asymmetric deg	Asymmetric	94 %	0.970	-
Z5	Asymmetric deg	Asymmetric	92 %	-	-
Z5M1/Z5M2	Asymmetric deg	Asymmetric	94 %	0.900	-

D C B A

4

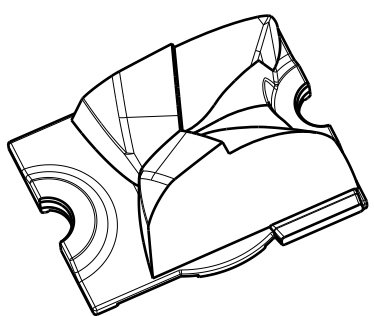

Isometric view

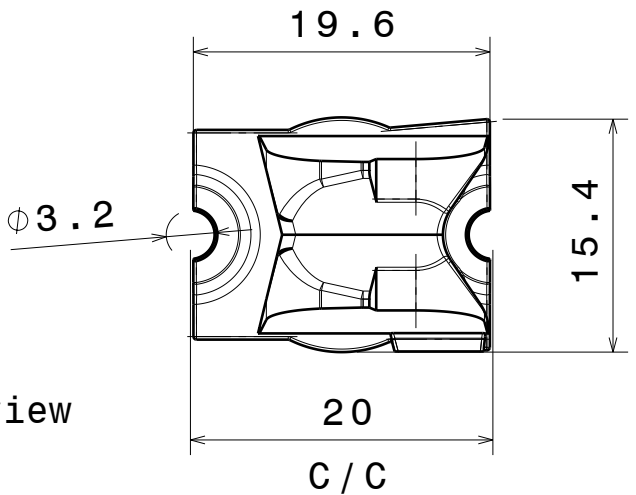

Top view

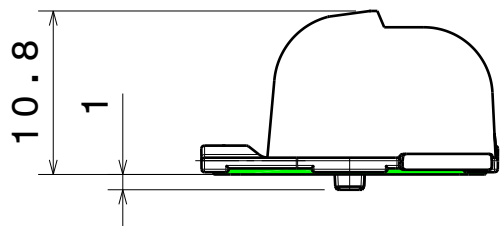

Front view

Tape 0.4mm

Led position

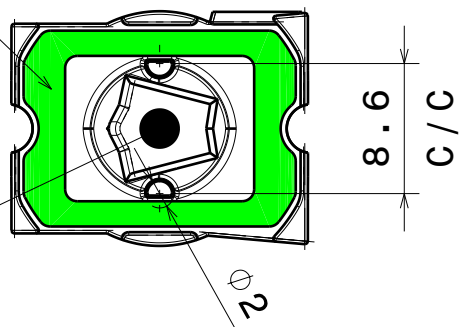

Bottom view

MATERIALS
 Lens: PMMA
 Colour: Clear

3

2

Tolerances if not otherwise shown
 According to DIN ISO 2768-1
 Linear measures:
 Up to 30mm class M, otherwise class C.
 According to DIN ISO 2768-2
 Form and position: class L

LEDiL Ledil Oy
 Salorankatu 10
 FIN 24240 SALO
 Finland

THIRD ANGLE PROJECTION:

DRAWING TITLE
STRADA - FW

This drawing is the property of LEDiL Oy. It may not be reproduced, copied or communicated without a written agreement with LEDiL Oy."

SIZE	PART NUMBER
A4	CA12087

SCALE	2:1	WEIGHT	-	SHEET	1/1
-------	-----	--------	---	-------	-----

1

D A

Luminaire: LEDil Oy CA12087_STRADA-FW_(XM-L2) Efficiency=94%
Lamps: 1 x Cree XM-L2 (XMLBWT-0-7B4-T30-0L-0001) 91lm @ 250mA CCT=3200K P=0.7W I=250mA

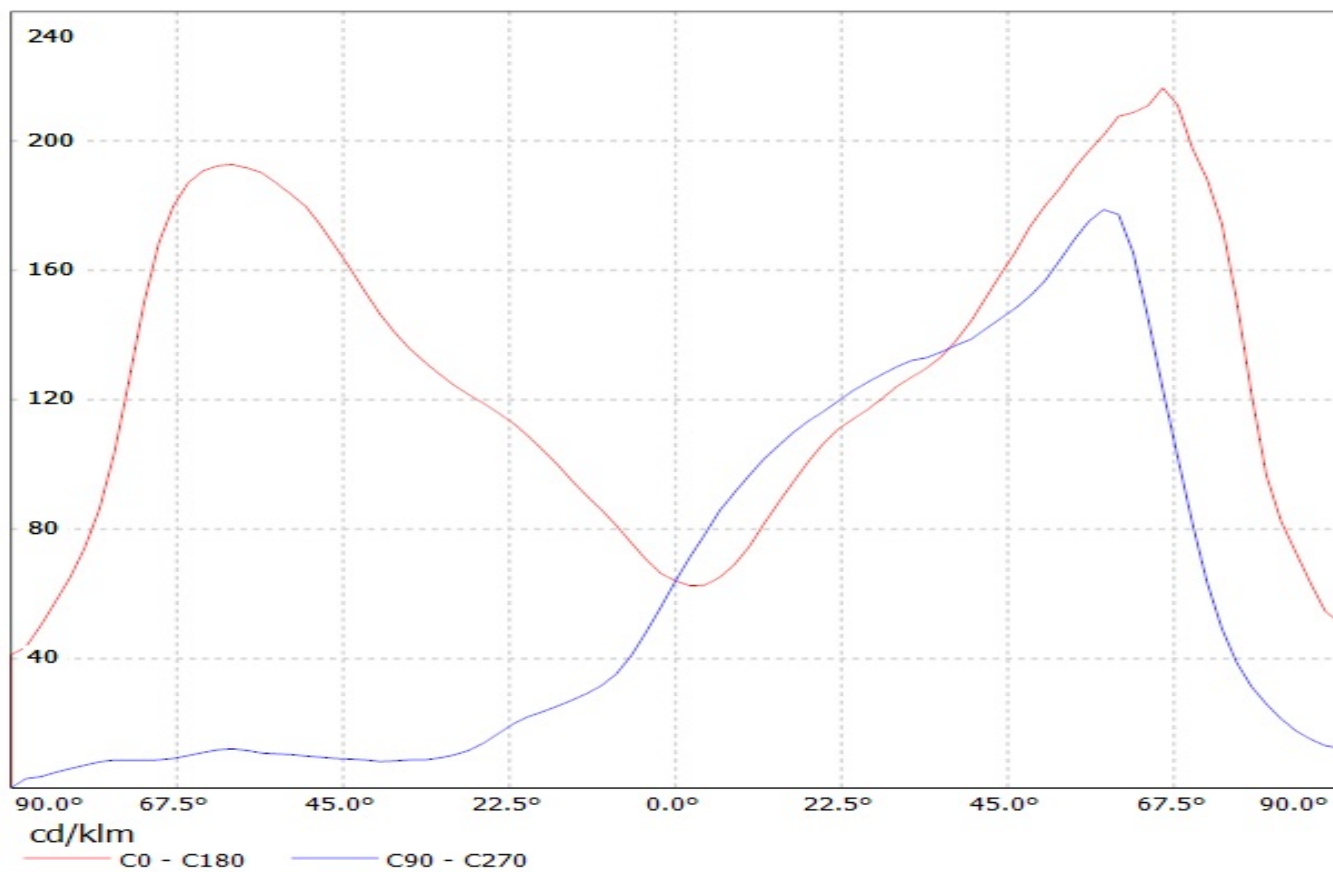

Luminaire: LEDil Oy CA12087_STRADA-FW_(XP-G2) Efficiency=93%
Lamps: 1 x Cree XP-G2 (XPGBWT-L1-0000-00FE4) 101lm @ 250mA CCT=6600K P=0.7W I=250mA

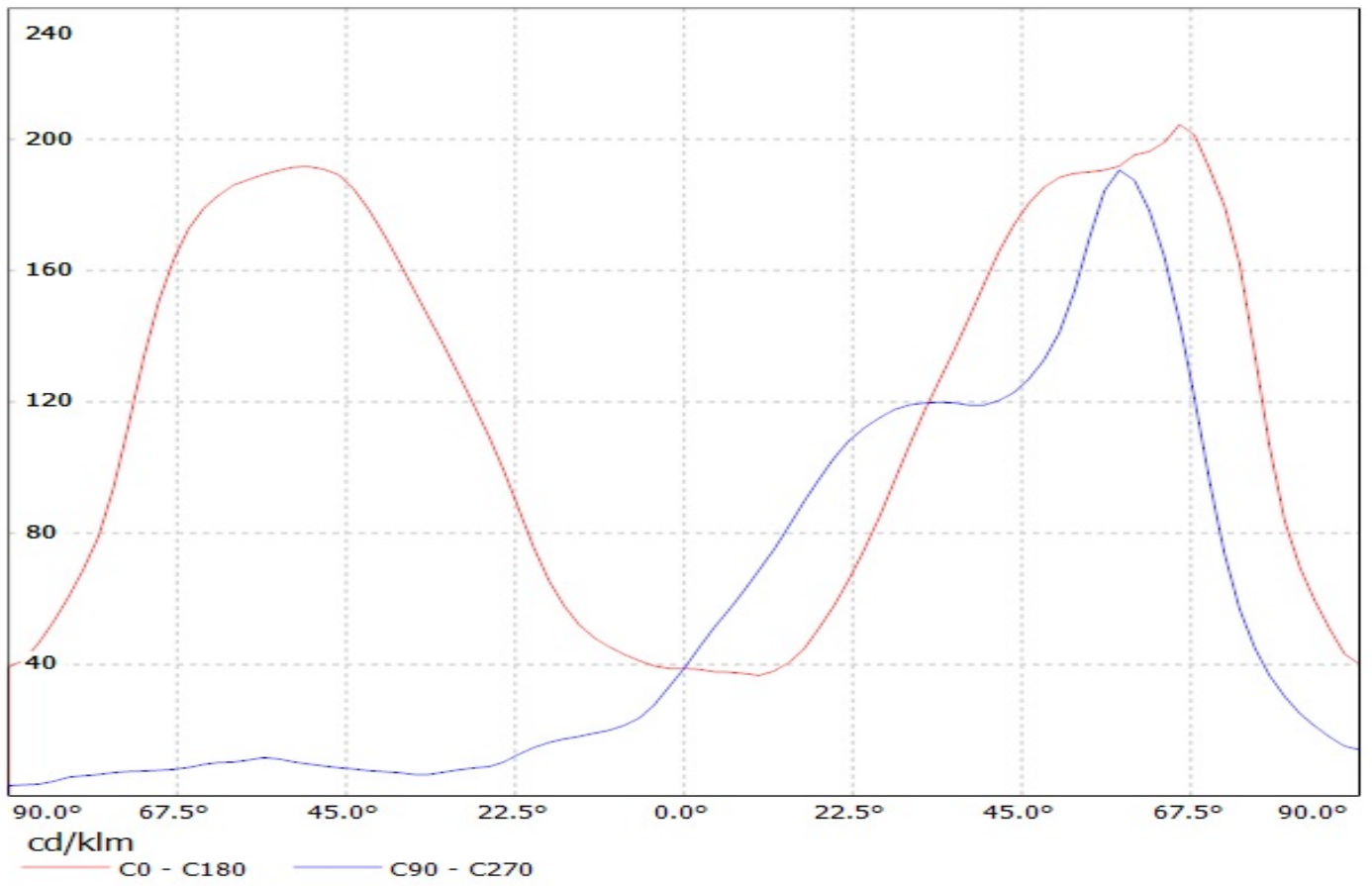

Luminaire: LEDiL Oy CA12087_STRADA-FW_(XP-L)
Lamps: 1 x Cree_XP-L_125.481lm@250mA_P=0.737584W_I=249.9mA

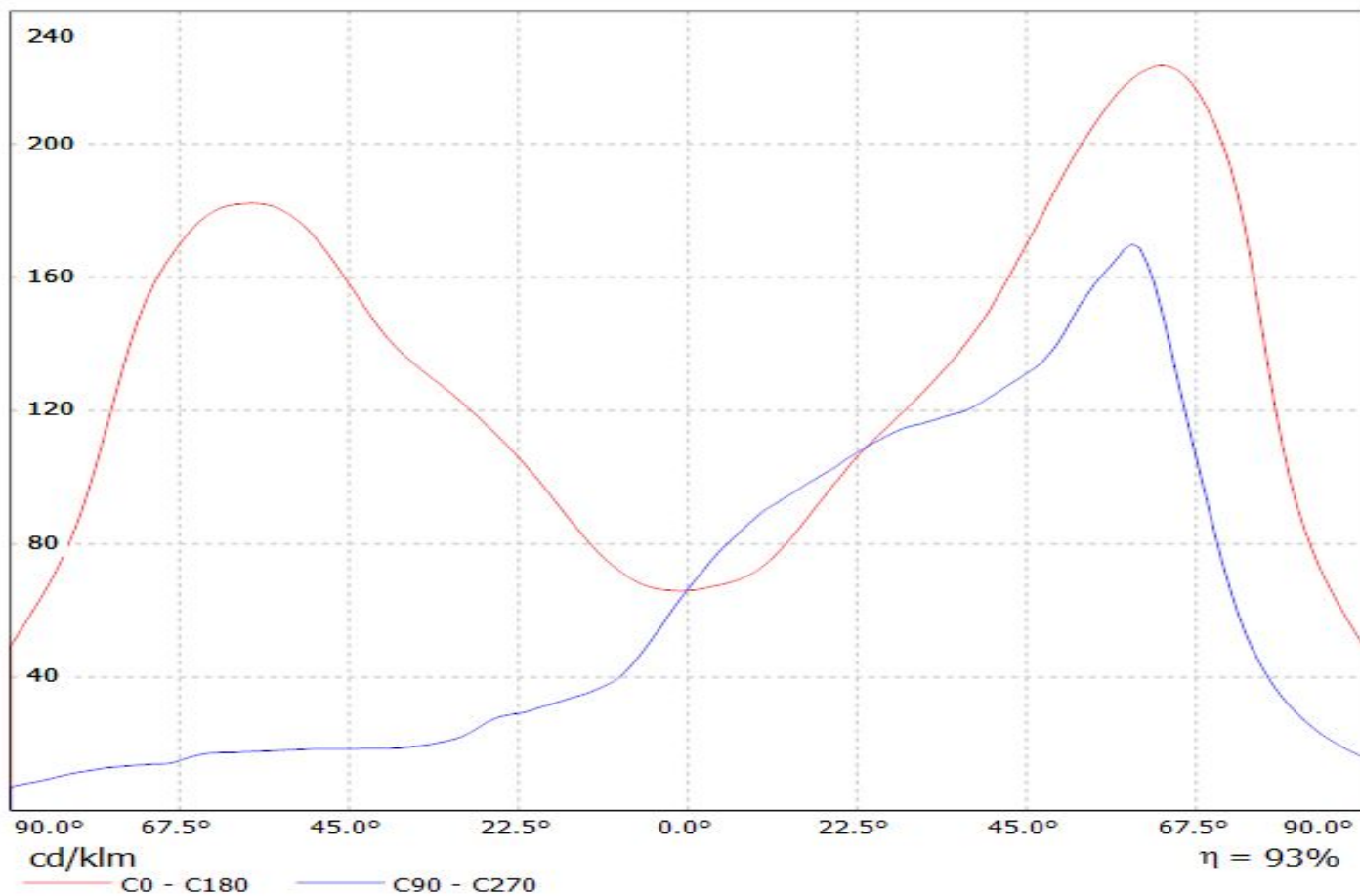

Luminaire: Ledil CA12087_STRADA-FW_(XP-L2)

Lamps: 1 x Cree_XP-L2_(XPLWT-00-0000-000HU630G)_115.75lm@250mA_P=0.721375W_I=0.25A

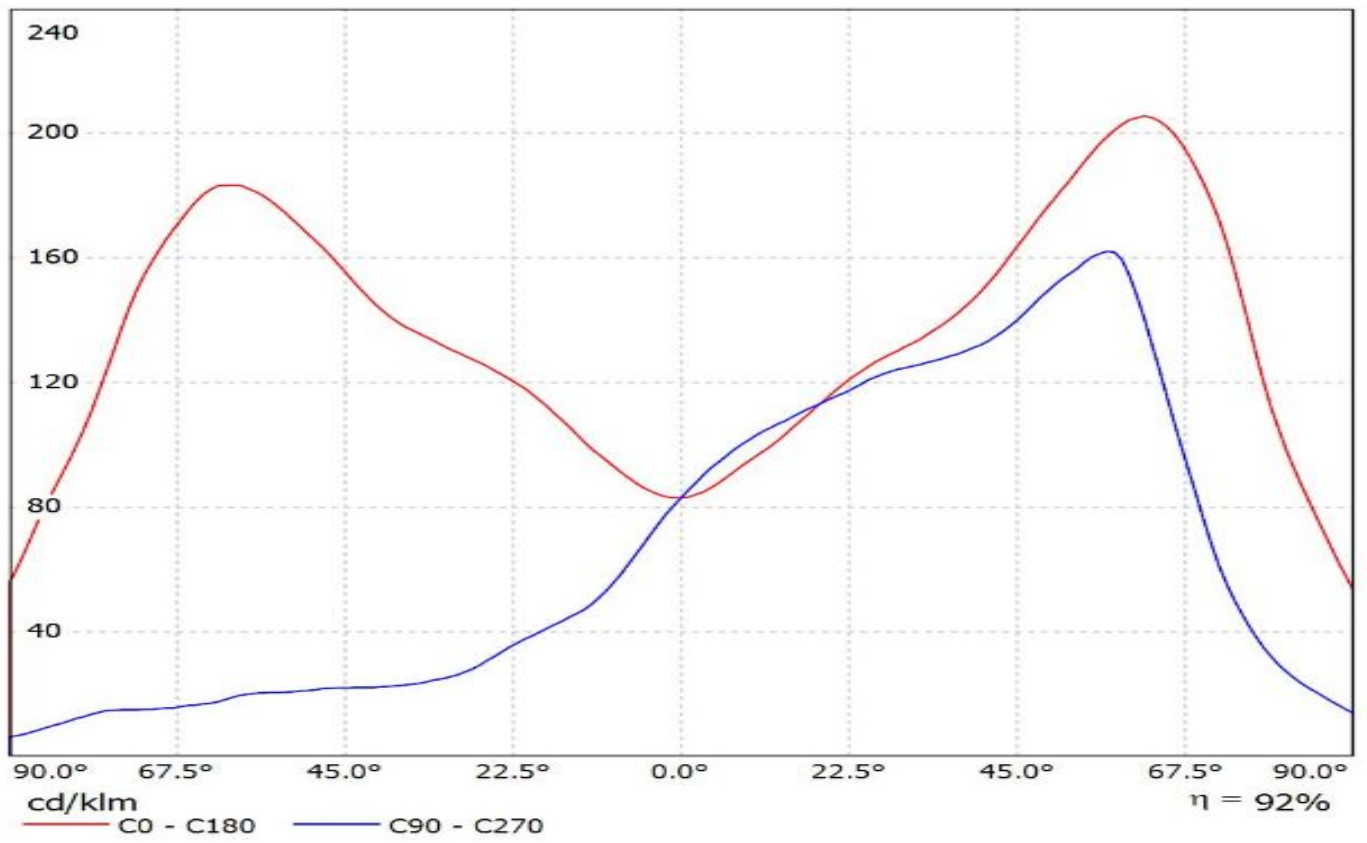

Luminaire: LEDiL Oy CA12087_STRADA-FW_(LG3535) Eff. 88,2%
Lamps: 1 x LG Ceramic 3535 PKG (95lm@250mA)

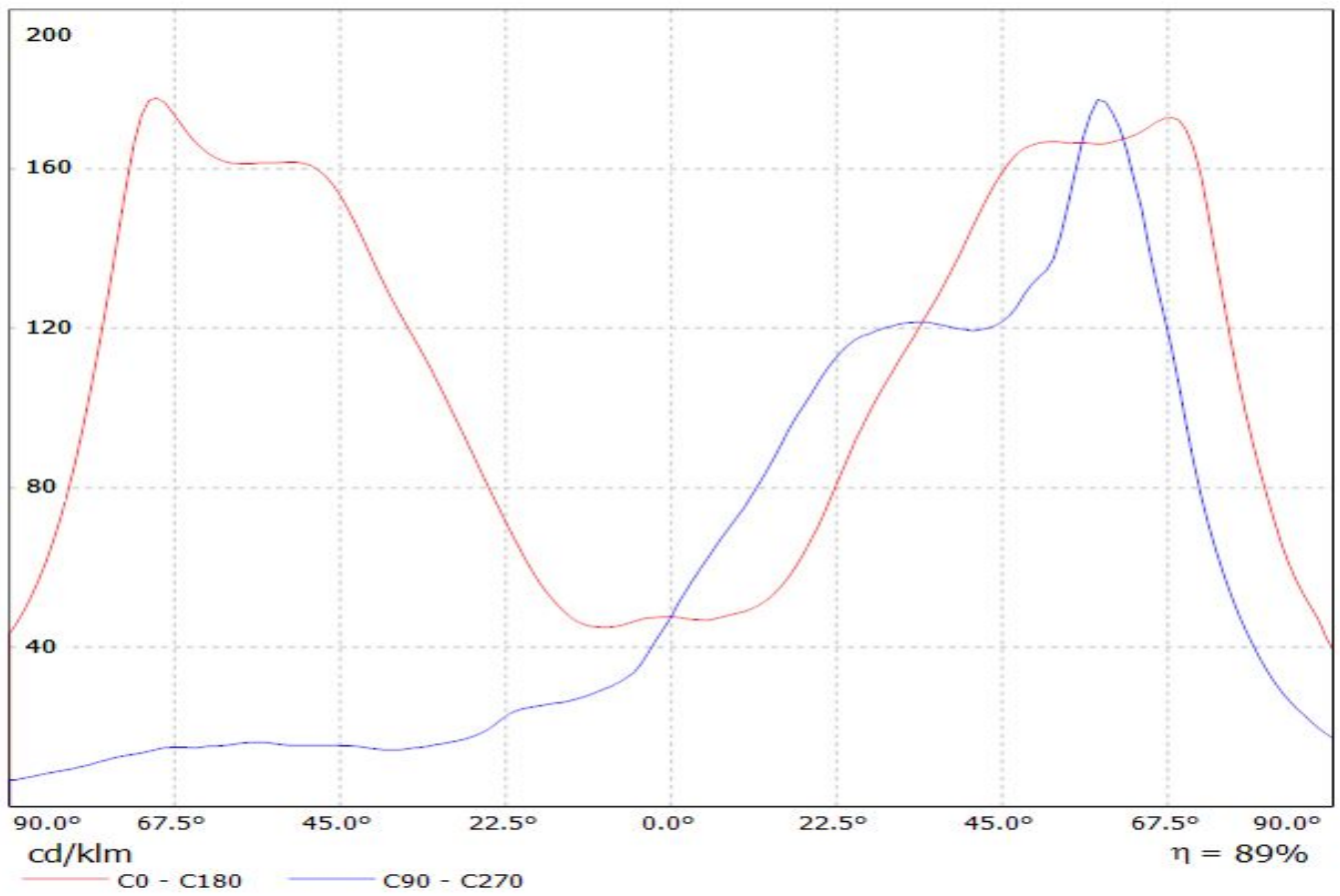

LEDiL Oy CA12087_STRADA-FW_(LG3535_2W) Eff.90.3% / LDC (Linear)

Luminaire: LEDiL Oy CA12087_STRADA-FW_(LG3535_2W) Eff.90.3%
Lamps: 1 x LG3535_2W (97.3629lm@250mA)

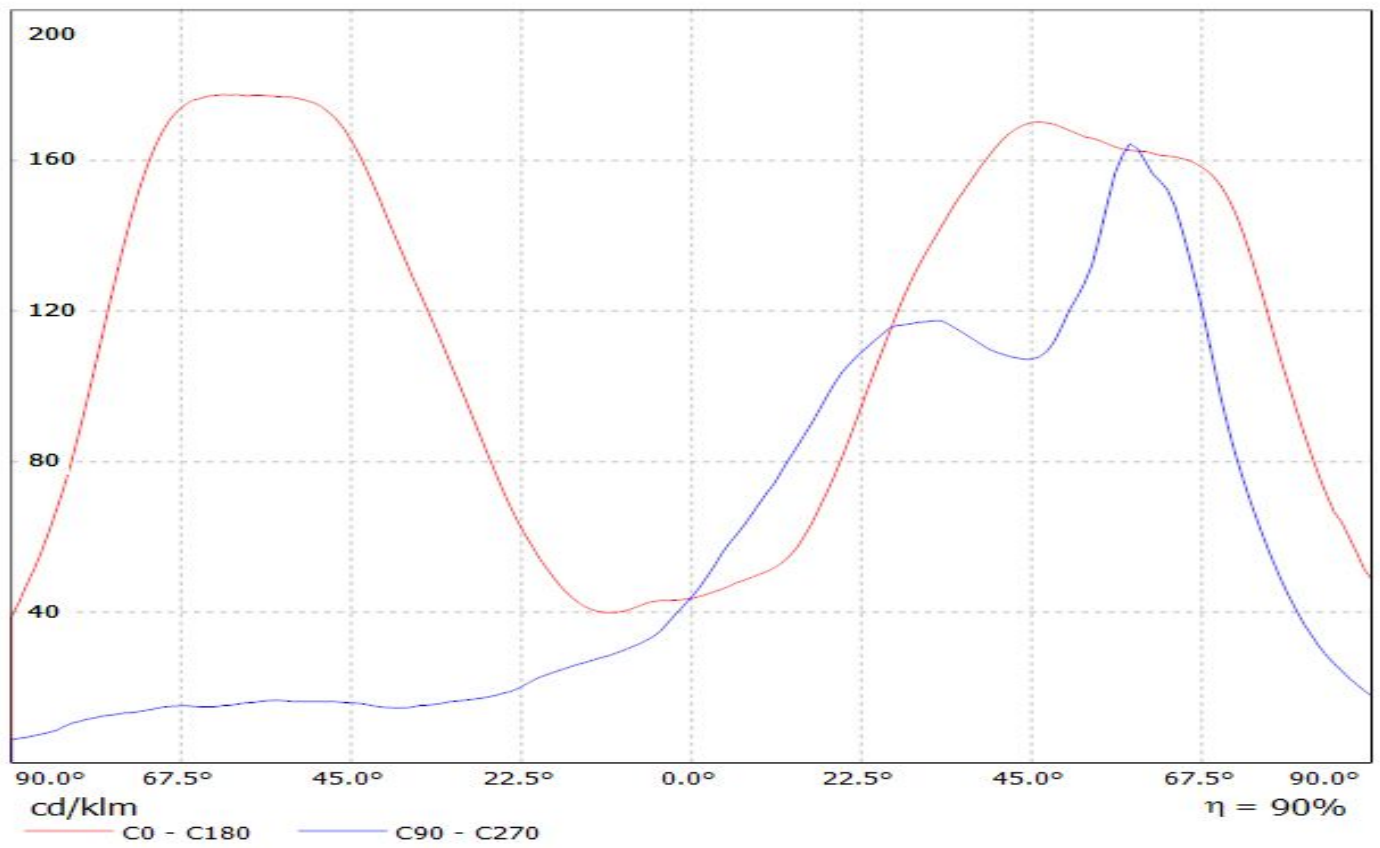

Luminaire: LEDiL Oy CA12087_STRADA-FW_(Luxeon_Z_ES) Eff.90.6%
Lamps: 1 x Luxeon_Z_ES_(LXZ2-3090)_50.8881lm@250mA_P=0.730433W_I=249.9mA

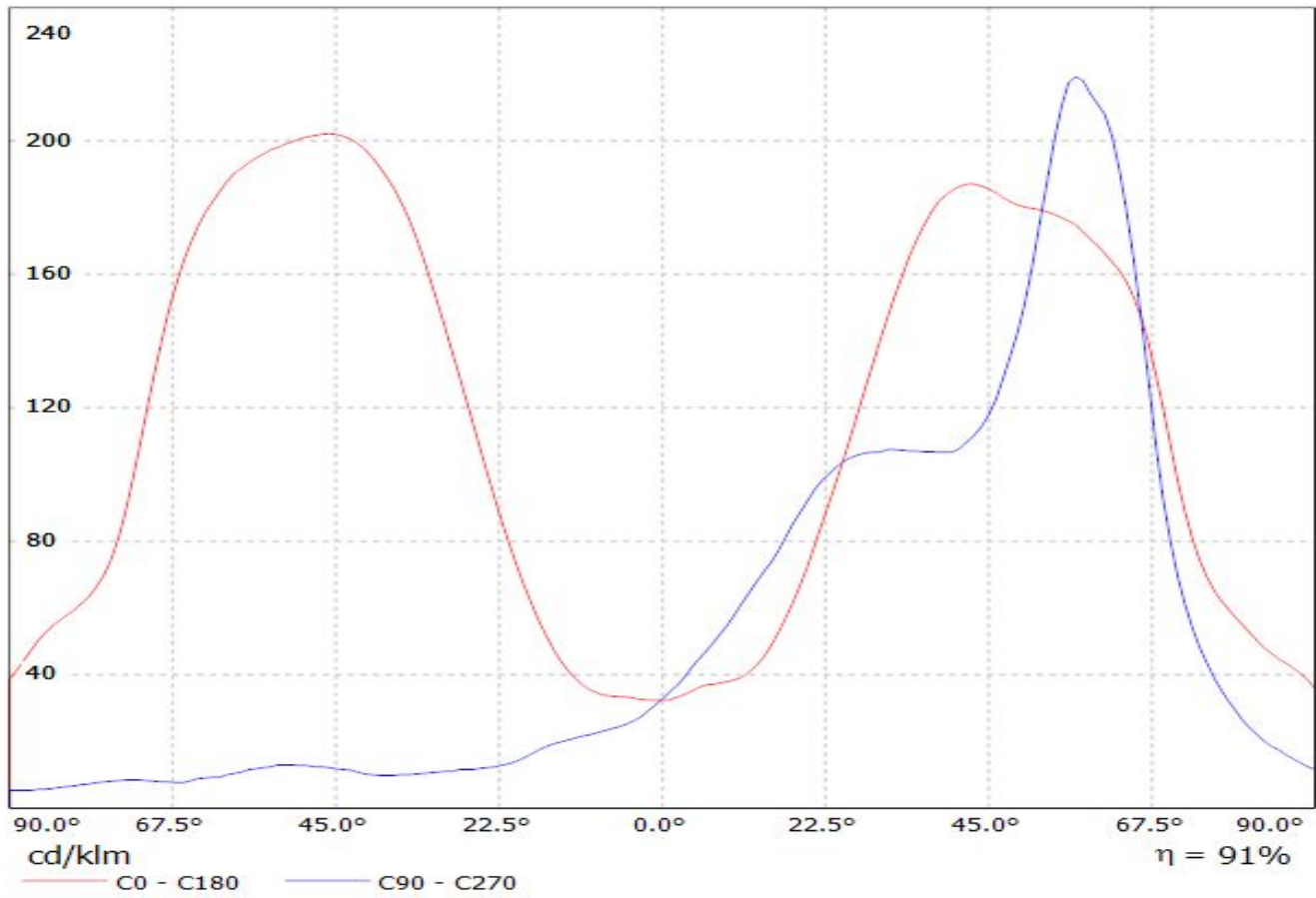

Luminaire: LEDiL Oy CA12087_STRADA-FW_(Luxeon_T)
Lamps: 1 x Luxeon_T_(LXH8-FW30-3)_70lm@250mA P=0.8W I=249.9mA

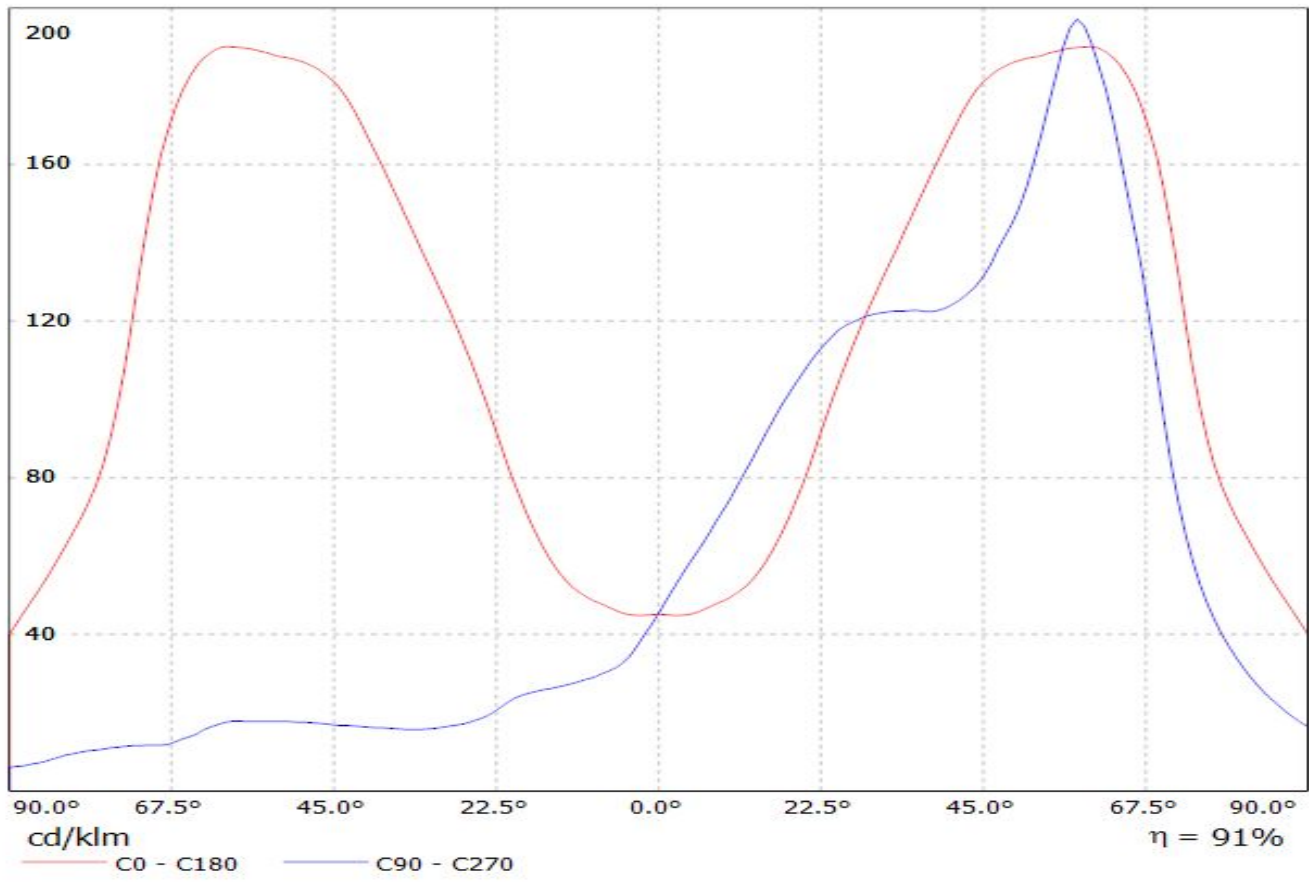

Luminaire: LEDiL Oy CA12087_STRADA-FW_(Luxeon_TX) Eff.93.2%
Lamps: 1 x Luxeon_TX_(L1T2-3585)_80.2531lm@250mA_CCT=3500K_P=0.730933W_I=249.9mA

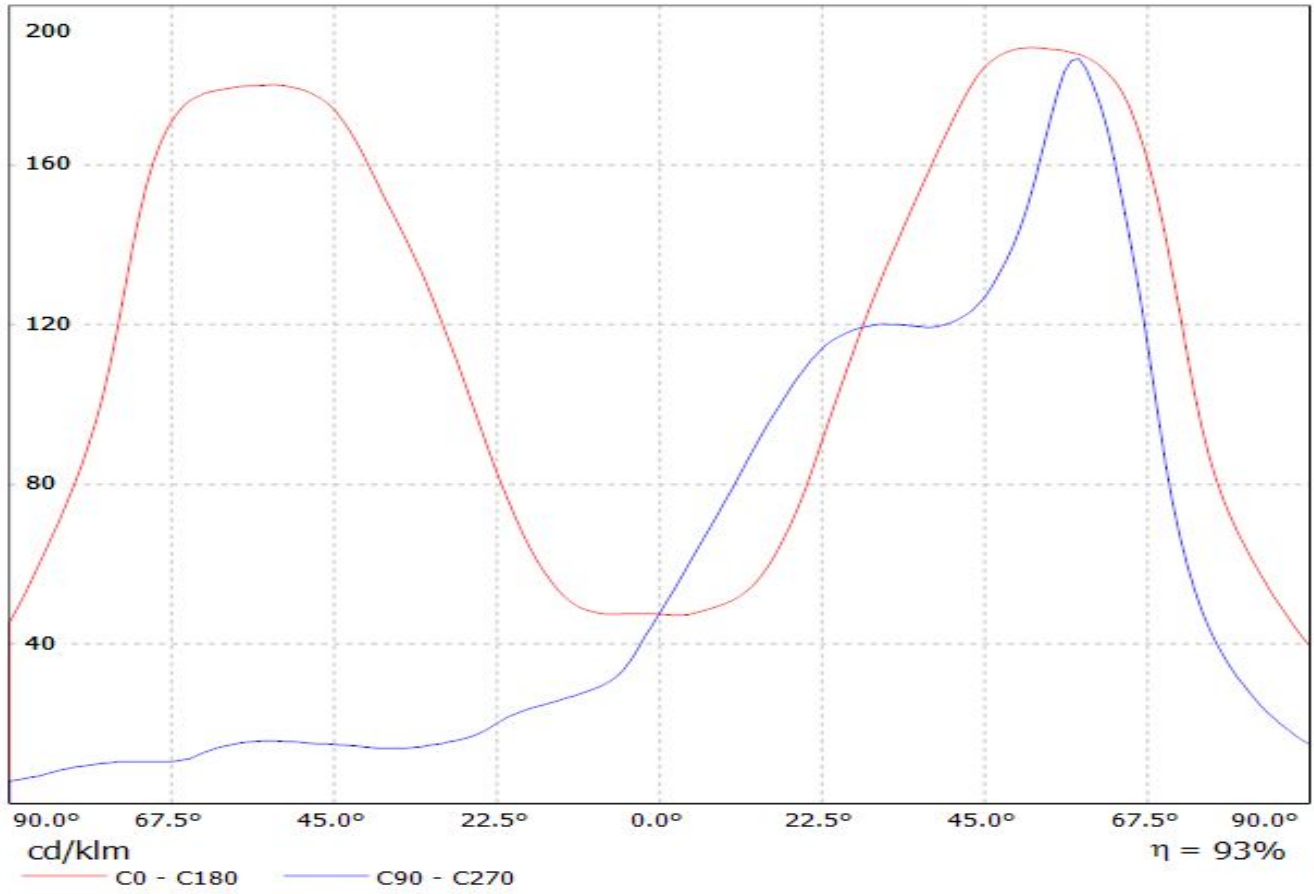

Ledil CA12087_STRADA-FW_(Fortimo_FastFlex_LED_board 2x8-757_DS_G3) / LDC (Linear)

Luminaire: Ledil CA12087_STRADA-FW_(Fortimo_FastFlex_LED_board 2x8-757_DS_G3)
Lamps: 1 x Philips_Fortimo_FastFlex_LED_board 2x8/757_DS_G3_(XP-G2)
_3428.78lm@500mA_P=23.7W_I=0.5A

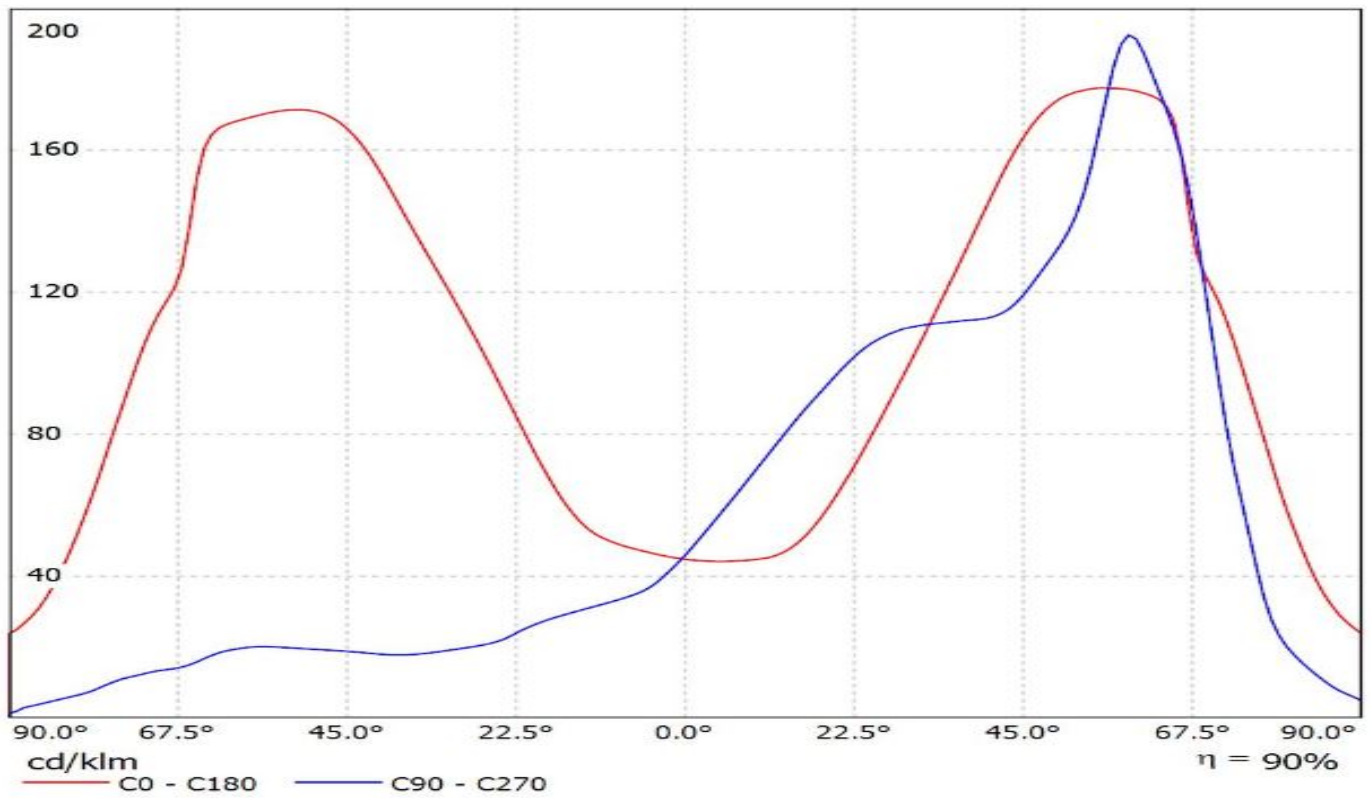

Luminaire: LEDiL Oy CA12087_STRADA-FW_(LH351Z) Eff.93.8%
Lamps: 1 x SAMSUNG_LH351Z_90.0548lm@250mA_P=0.747026W_I=249.9mA

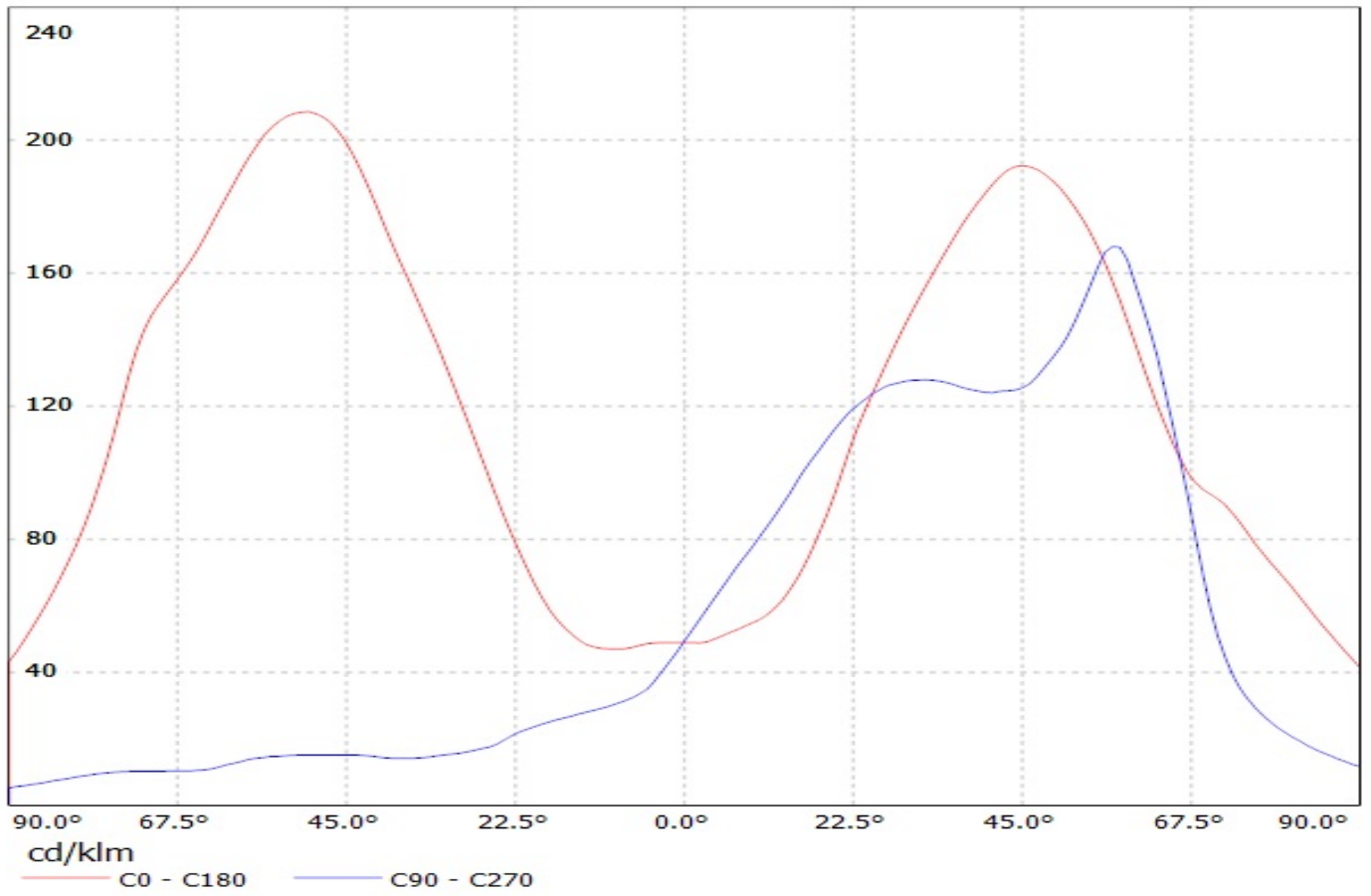

Luminaire: LEDil Oy CA12087_STRADA-FW_(Z5M1) Efficiency=94%
Lamps: 1 x Seoul Z5M1 (SZ5M1-W0-C8/W1-A5-G) 108lm @ 250mA CCT=9100K P=0.8W I=250mA

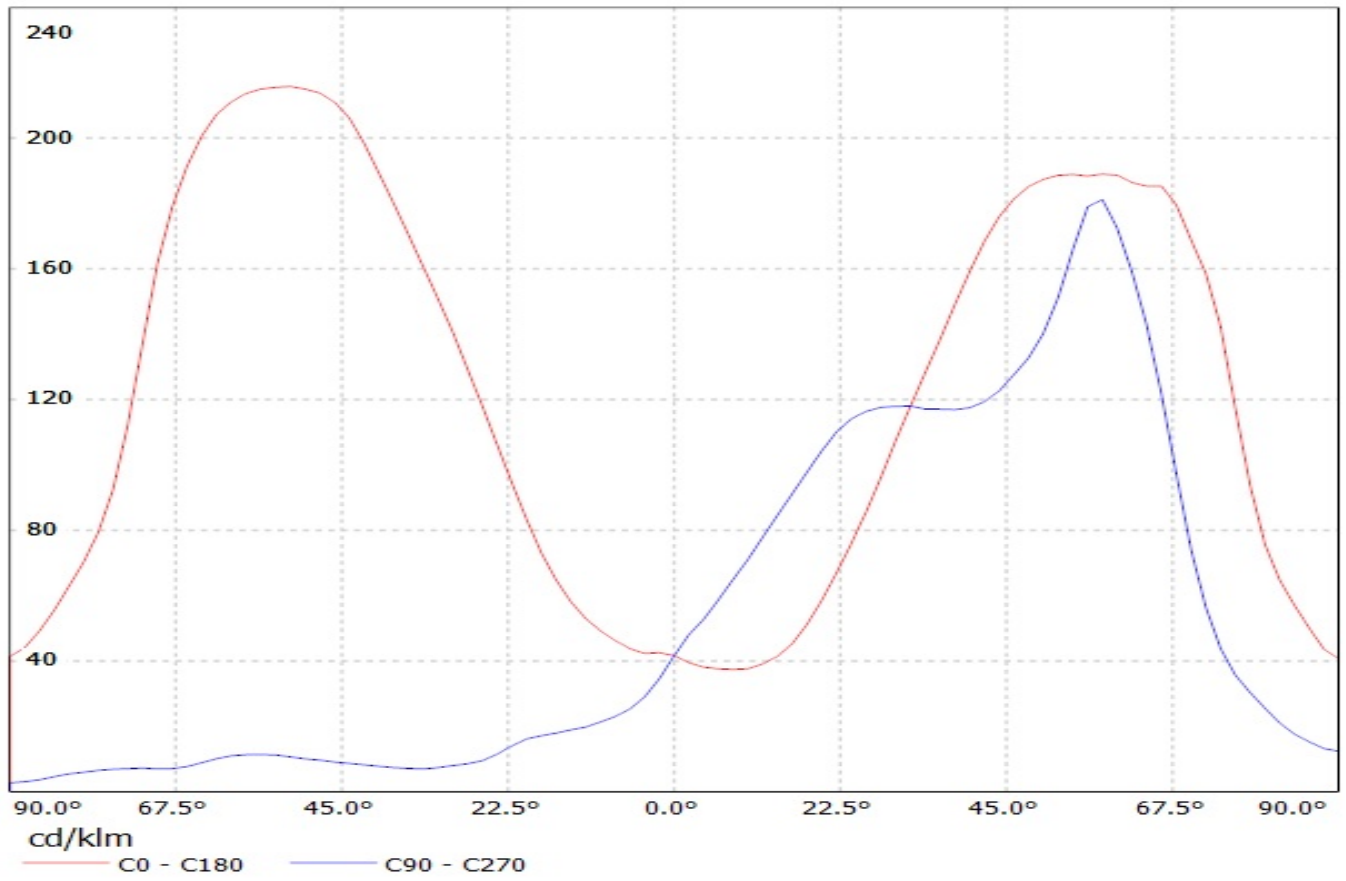

Luminaire: LEDil Oy CA12087_STRADA-FW_(XM-L2) Efficiency=94%

Lamps: 1 x Cree XM-L2 (XMLBWT-0-7B4-T30-0L-0001) 91lm @ 250mA CCT=3200K P=0.7W I=250mA

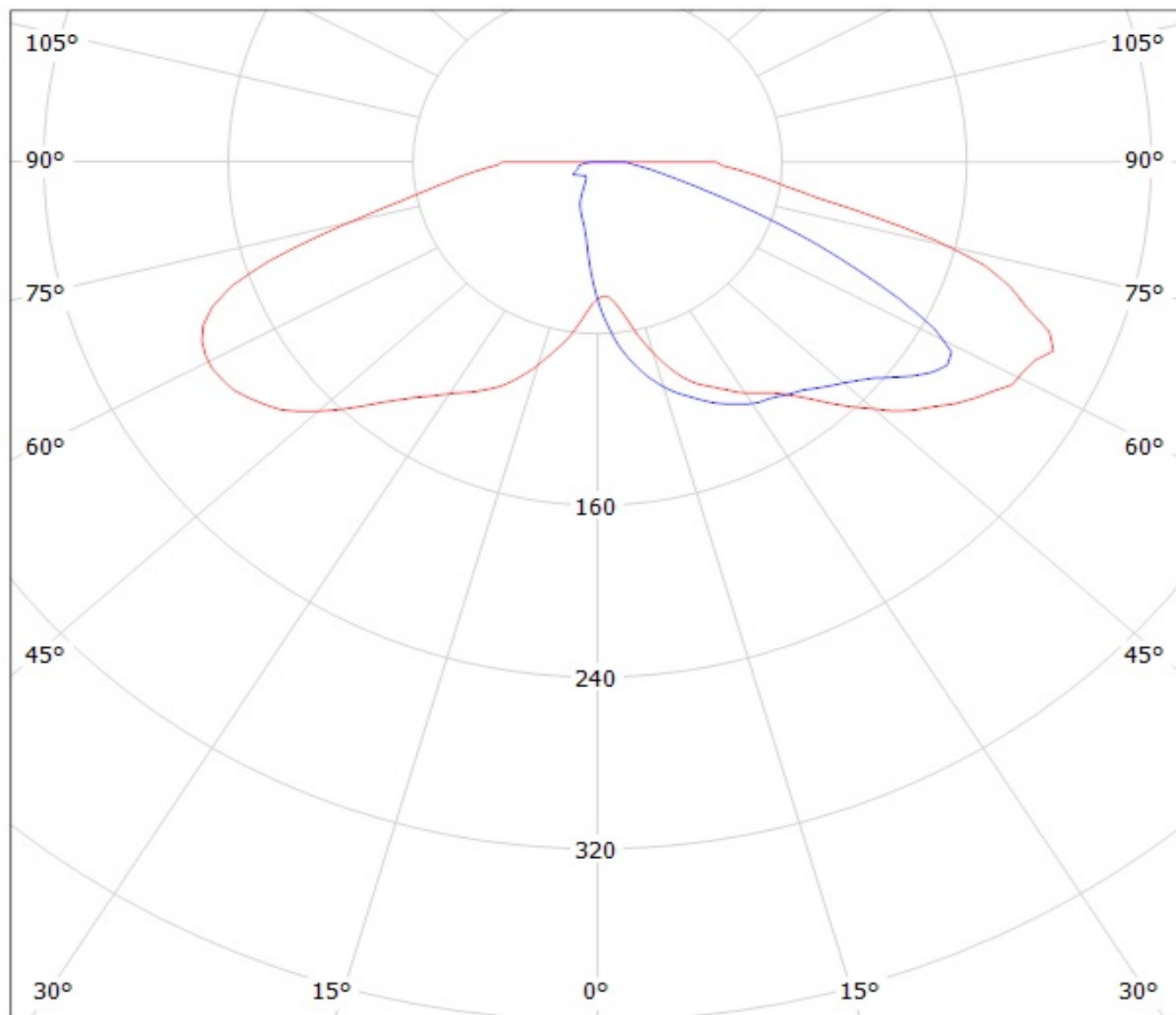

cd/klm

— C0 - C180

— C90 - C270

Luminaire: LEDil Oy CA12087_STRADA-FW_(XP-G2) Efficiency=93%

Lamps: 1 x Cree XP-G2 (XPGBWT-L1-0000-00FE4) 101lm @ 250mA CCT=6600K P=0.7W I=250mA

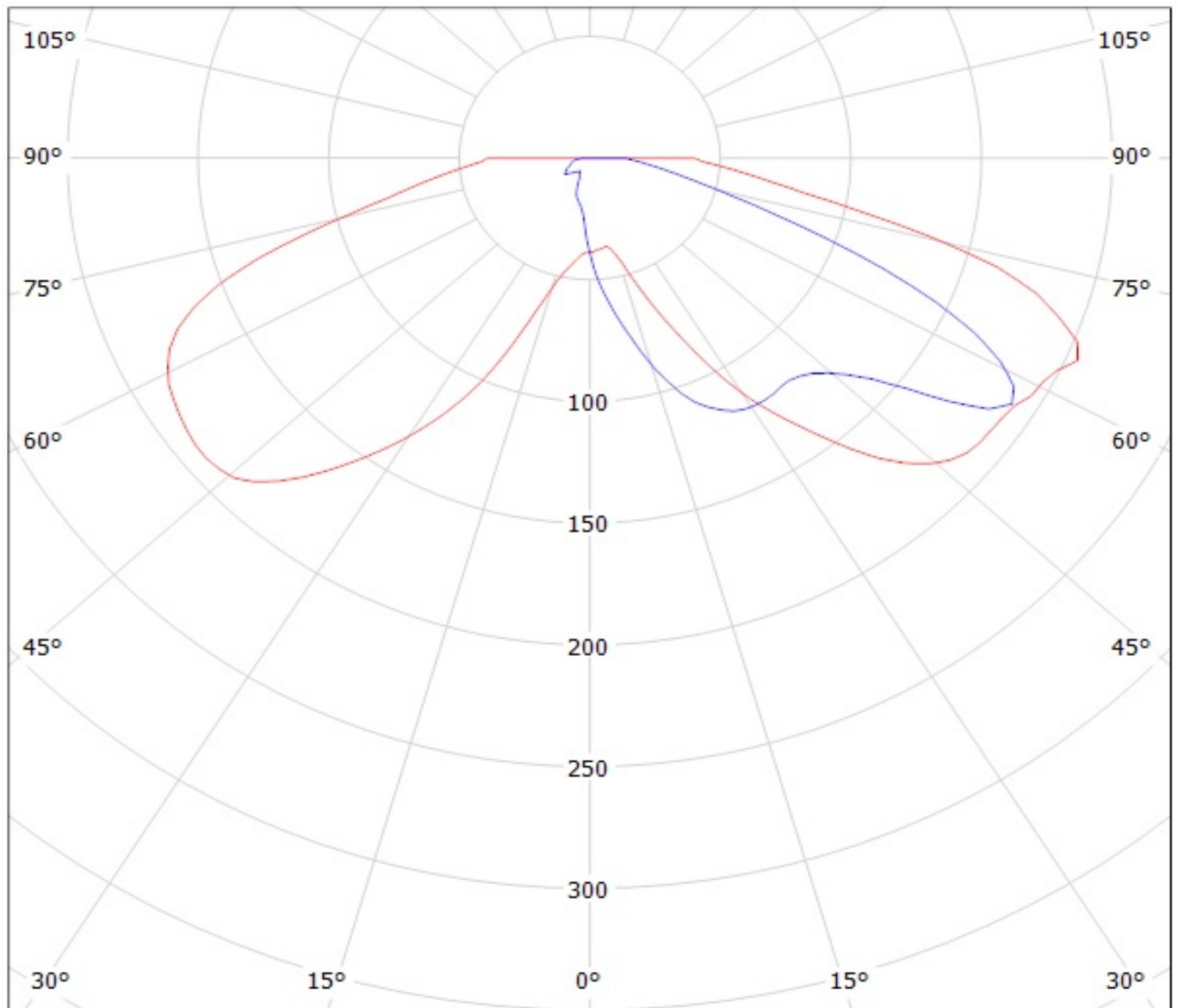

cd/klm

— C0 - C180

— C90 - C270

Luminaire: LEDiL Oy CA12087_STRADA-FW_(XP-L)

Lamps: 1 x Cree_XP-L_125.48lm@250mA_P=0.737584W_I=249.9mA

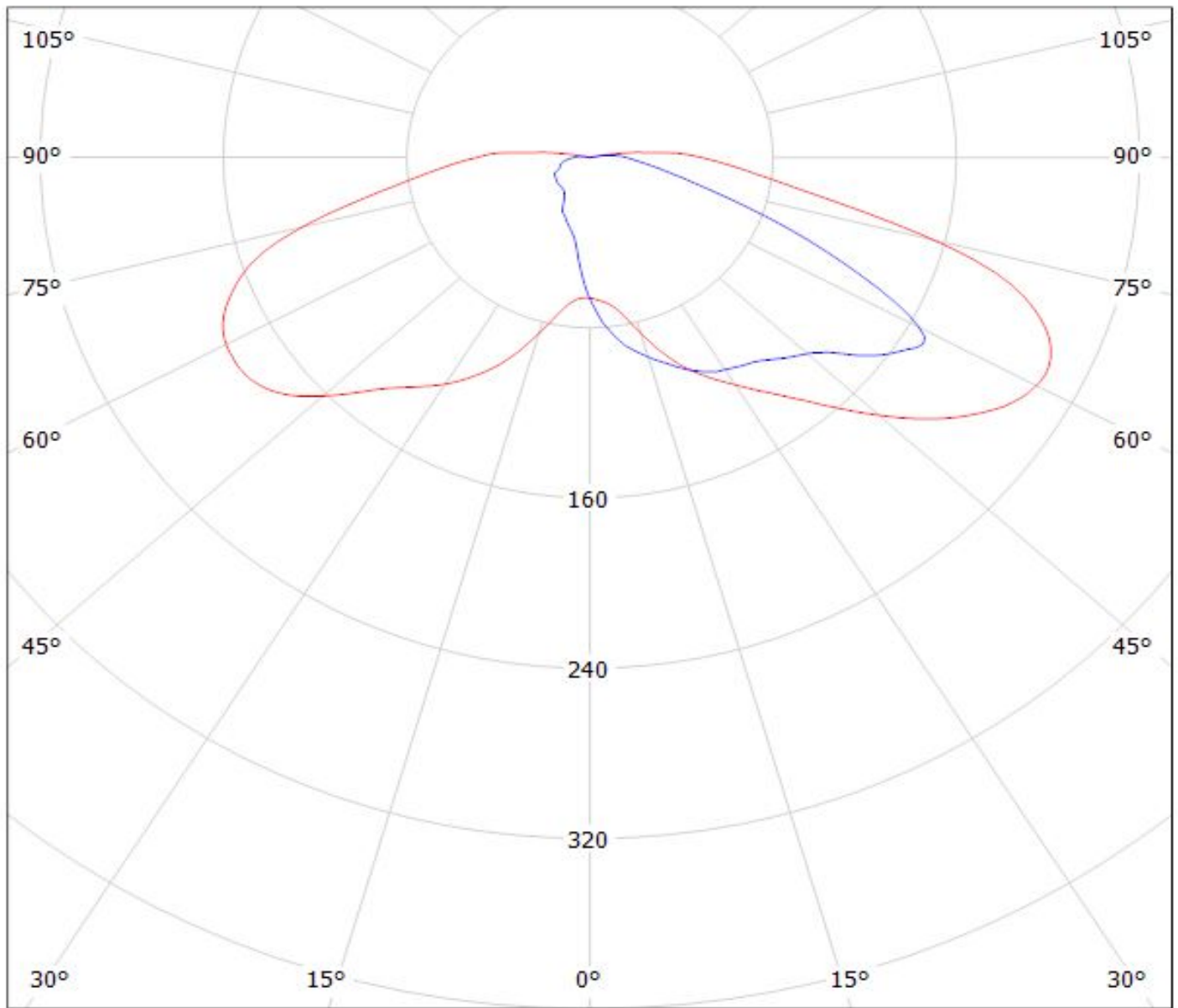

cd/klm

$\eta = 93\%$

— C0 - C180

— C90 - C270

Luminaire: Ledil CA12087_STRADA-FW_(XP-L2)

Lamps: 1 x Cree_XP-L2_(XPLWT-00-0000-000HU630G)_115.75lm@250mA_P=0.721375W_I=0.25A

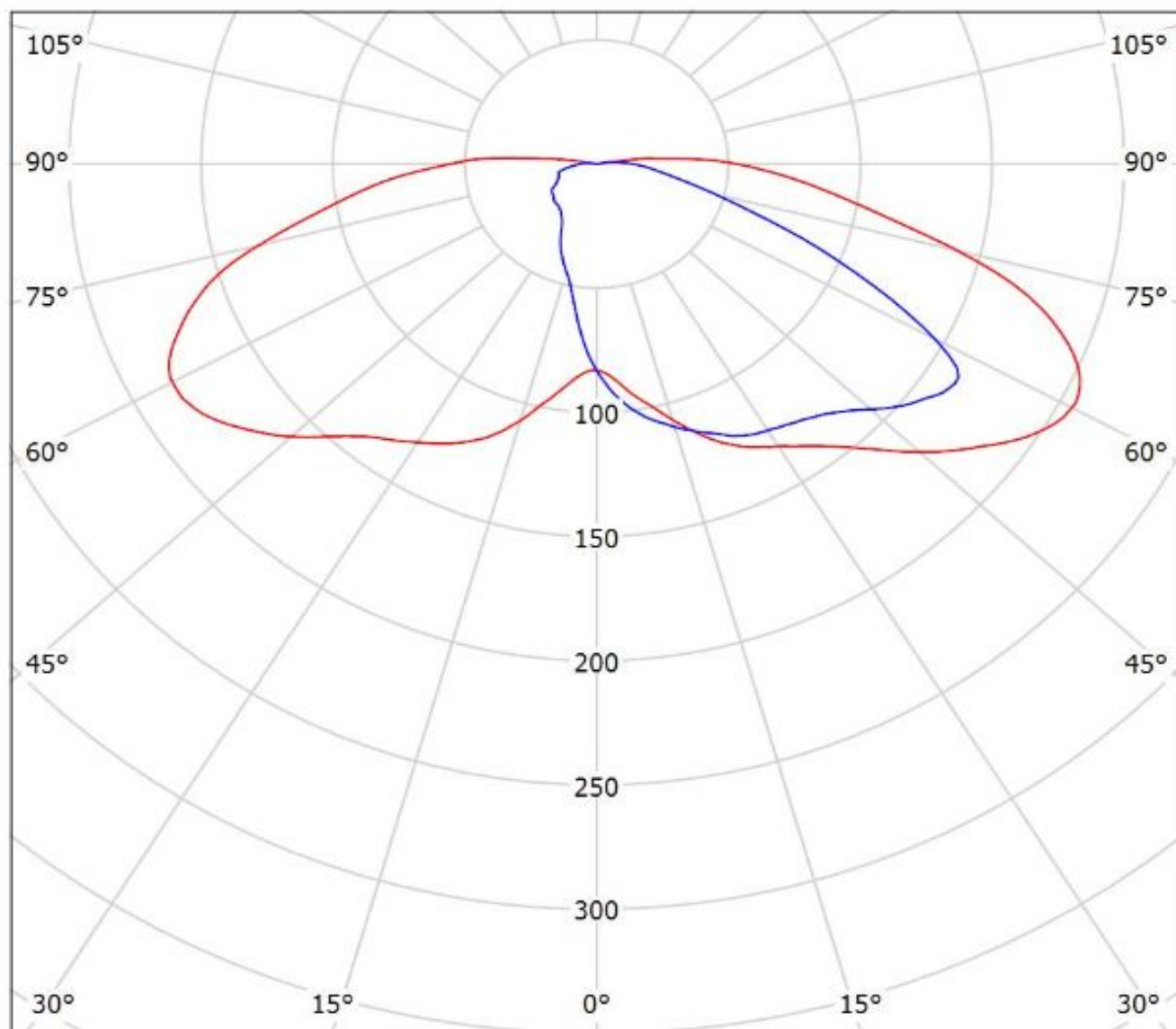

cd/klm

— C0 - C180

— C90 - C270

$\eta = 92\%$

Luminaire: LEDiL Oy CA12087_STRADA-FW_(LG3535) Eff. 88,2%
Lamps: 1 x LG Ceramic 3535 PKG (95lm@250mA)

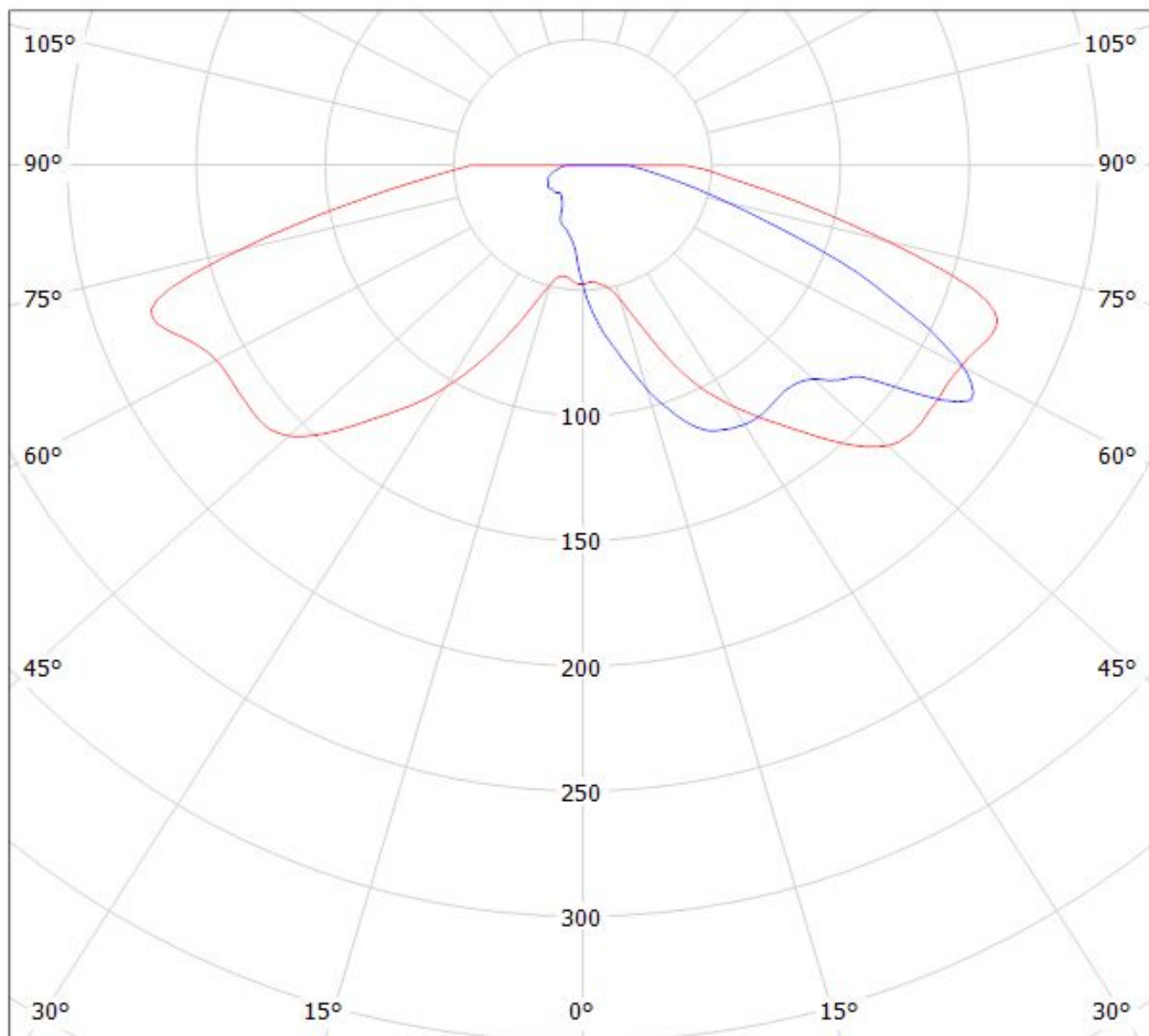

cd/klm

— C0 - C180

— C90 - C270

$\eta = 89\%$

LEDiL Oy CA12087_STRADA-FW_(LG3535_2W) Eff.90.3% / LDC (Polar)

Luminaire: LEDiL Oy CA12087_STRADA-FW_(LG3535_2W) Eff.90.3%

Lamps: 1 x LG3535_2W (97.3629lm@250mA)

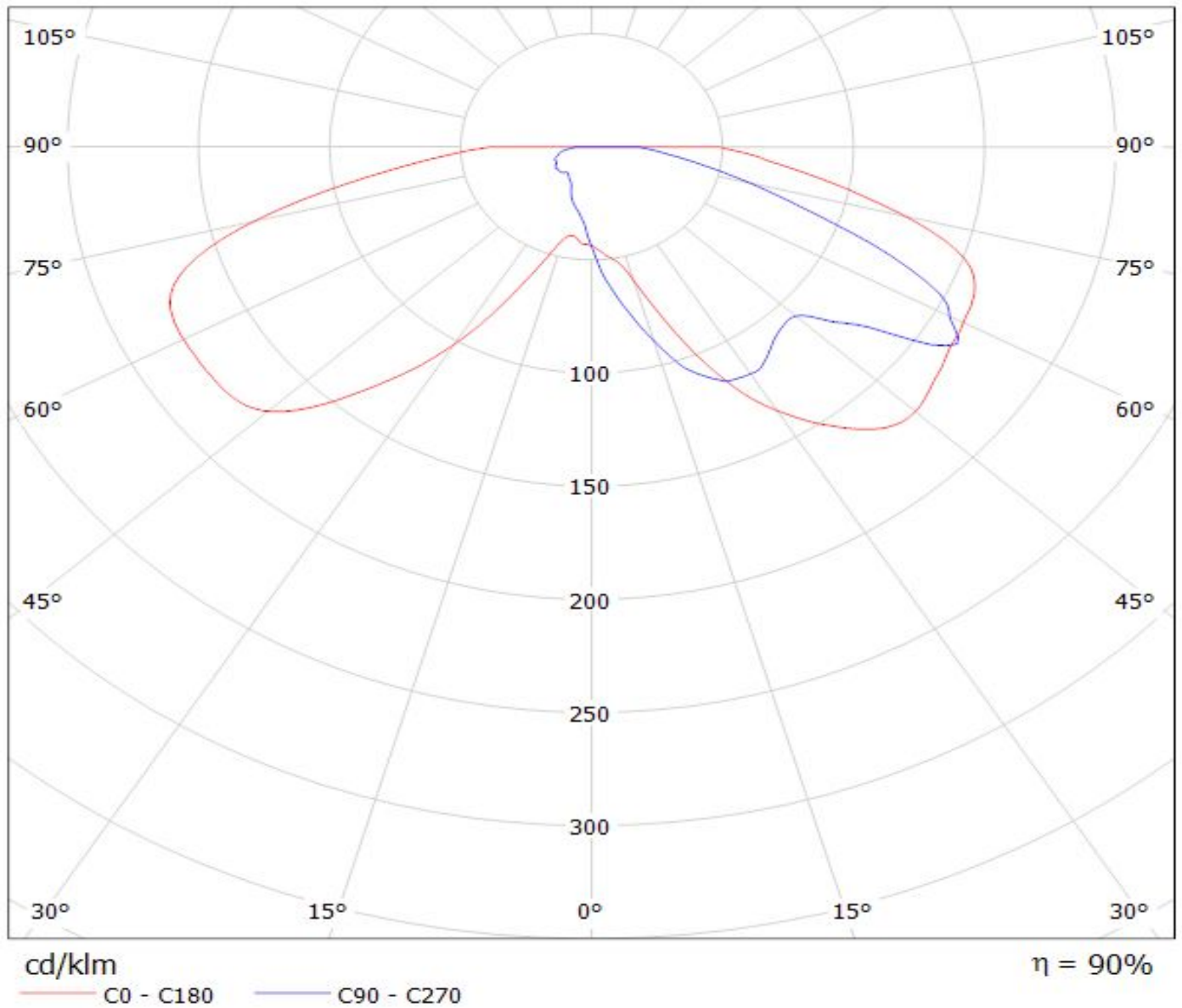

Luminaire: LEDiL Oy CA12087_STRADA-FW_(Luxeon_Z_ES) Eff.90.6%

Lamps: 1 x Luxeon_Z_ES_(LXZ2-3090)_50.8881lm@250mA_P=0.730433W_I=249.9mA

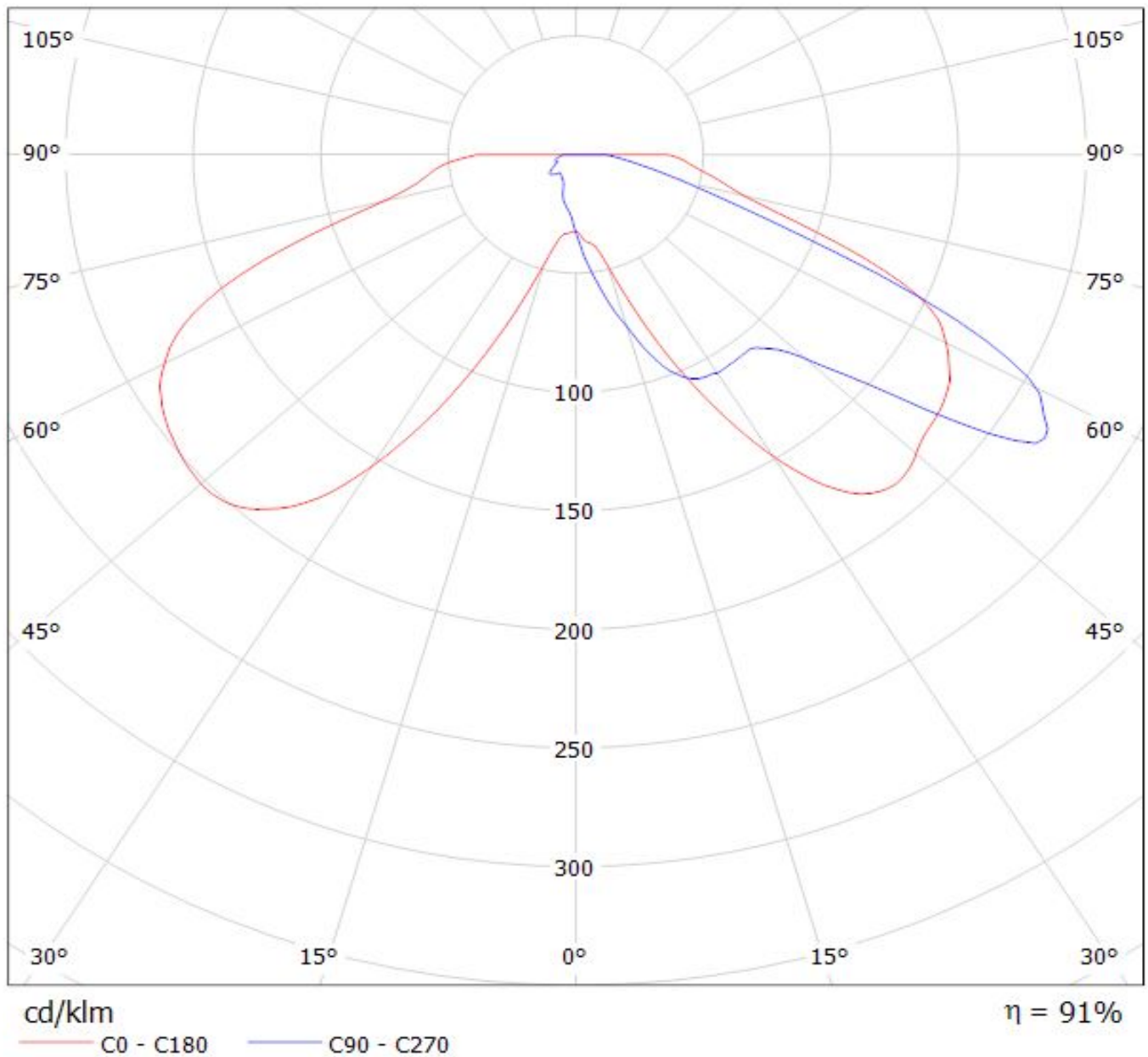

Luminaire: LEDiL Oy CA12087_STRADA-FW_(Luxeon_T)
Lamps: 1 x Luxeon_T_(LXH8-FW30-3)_70lm@250mA P=0.8W I=249.9mA

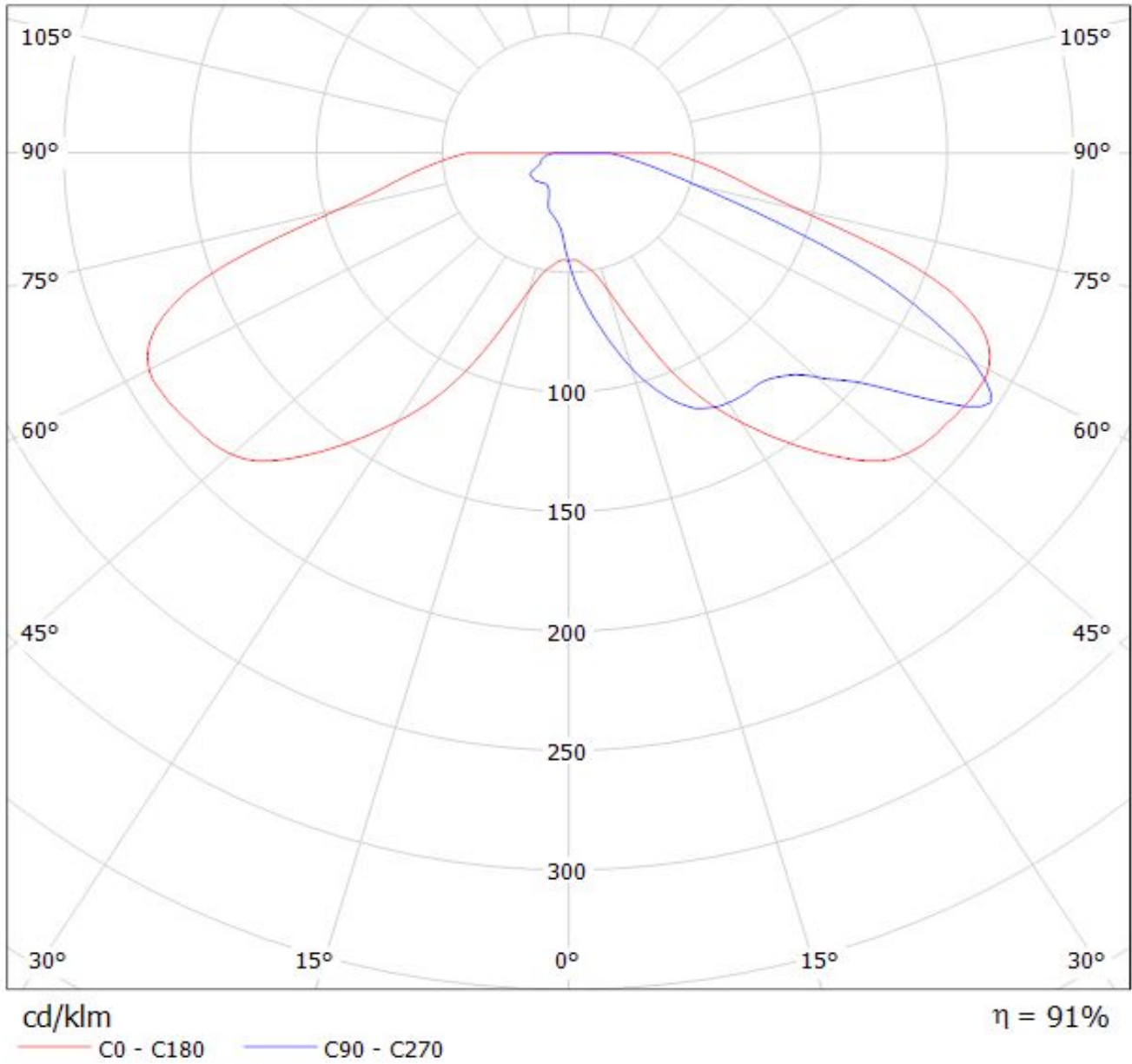

Luminaire: LEDiL Oy CA12087_STRADA-FW_(Luxeon_TX) Eff.93.2%

Lamps: 1 x Luxeon_TX_(L1T2-3585)_80.2531lm@250mA_CCT=3500K_P=0.730933W_I=249.9mA

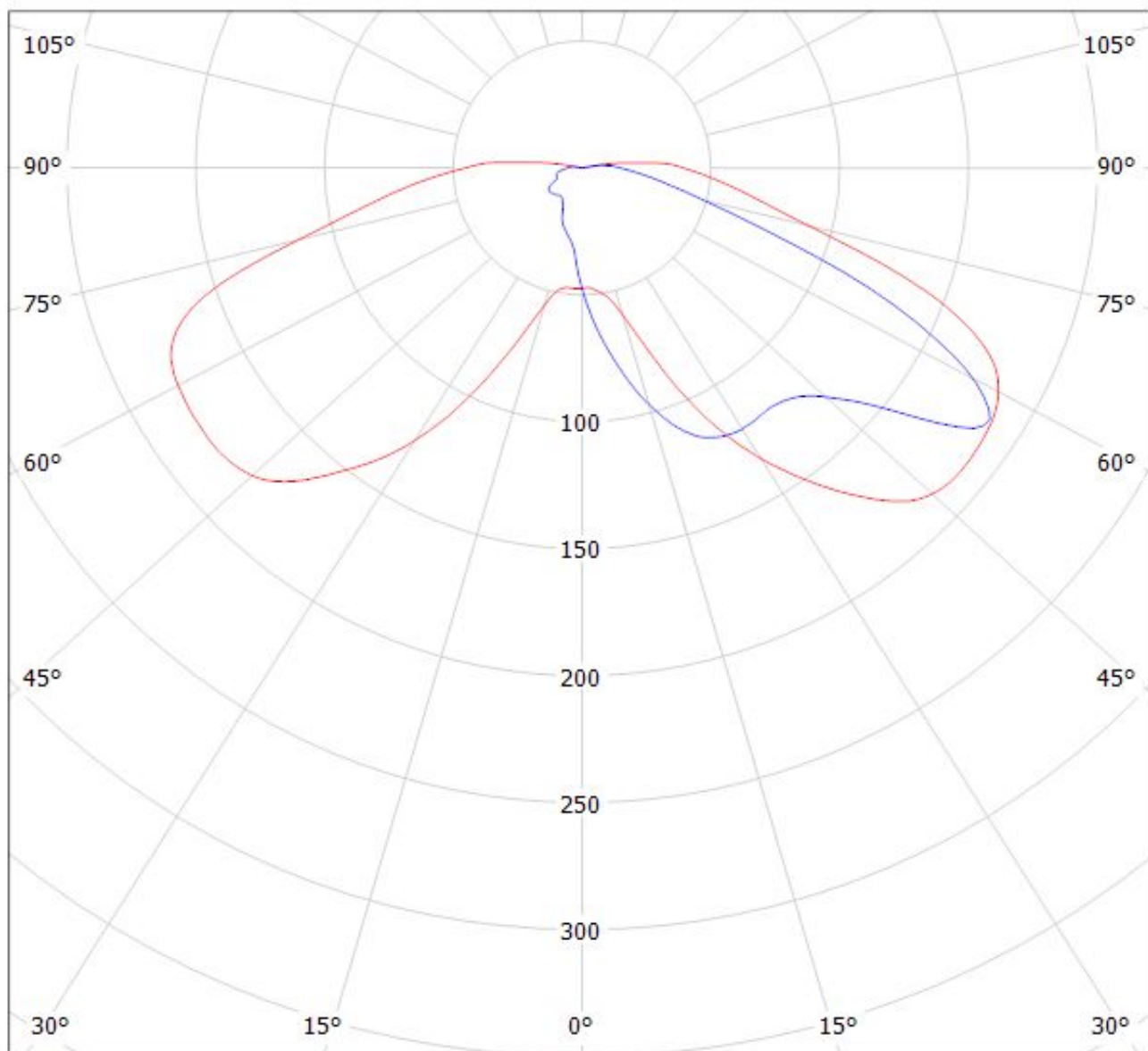

cd/klm

— C0 - C180 — C90 - C270

$\eta = 93\%$

Ledil CA12087_STRADA-FW_(Fortimo_FastFlex_LED_board 2x8-757_DS_G3) / LDC (Polar)

Luminaire: Ledil CA12087_STRADA-FW_(Fortimo_FastFlex_LED_board 2x8-757_DS_G3)

Lamps: 1 x Philips_Fortimo_FastFlex_LED_board 2x8/757_DS_G3_(XP-G2)

_3428.78lm@500mA_P=23.7W_I=0.5A

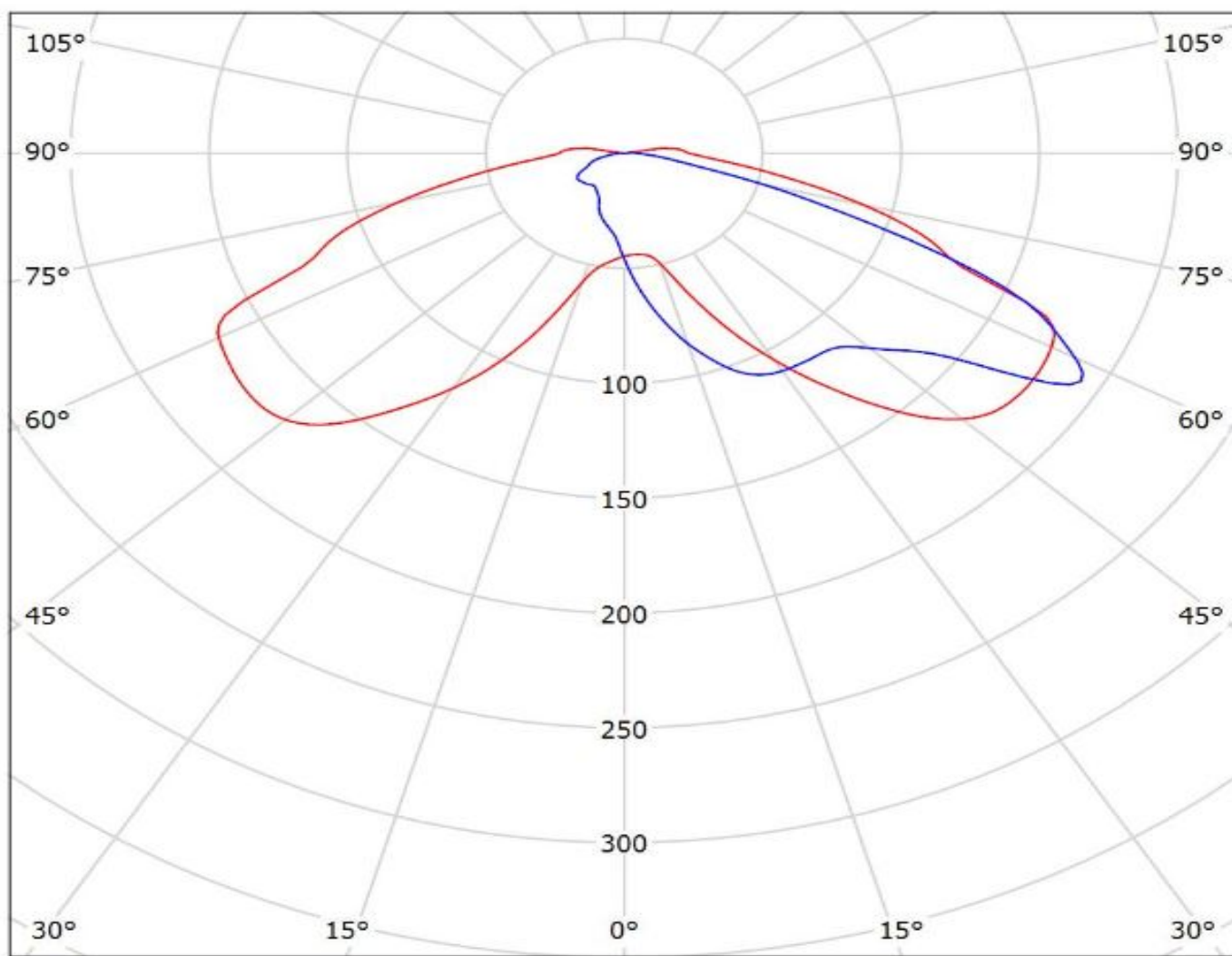

cd/klm

— C0 - C180 — C90 - C270

$\eta = 90\%$

Luminaire: LEDiL Oy CA12087_STRADA-FW_(LH351Z) Eff.93.8%
Lamps: 1 x SAMSUNG_LH351Z_90.0548lm@250mA_P=0.747026W_I=249.9mA

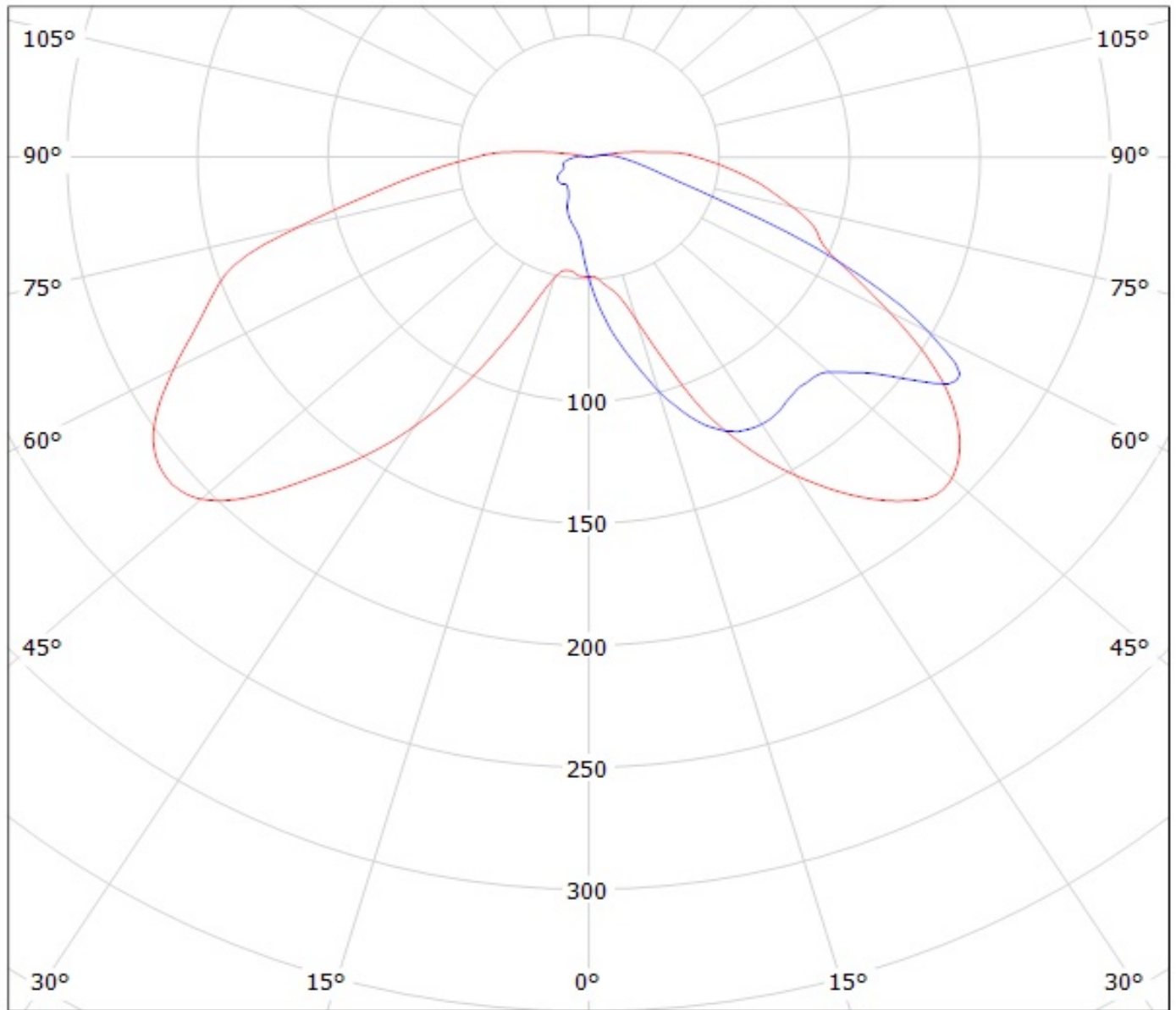

cd/klm

— C0 - C180

— C90 - C270

Luminaire: LEDil Oy CA12087_STRADA-FW_(Z5M1) Efficiency=94%

Lamps: 1 x Seoul Z5M1 (SZ5M1-W0-C8/W1-A5-G) 108lm @ 250mA CCT=9100K P=0.8W I=250mA

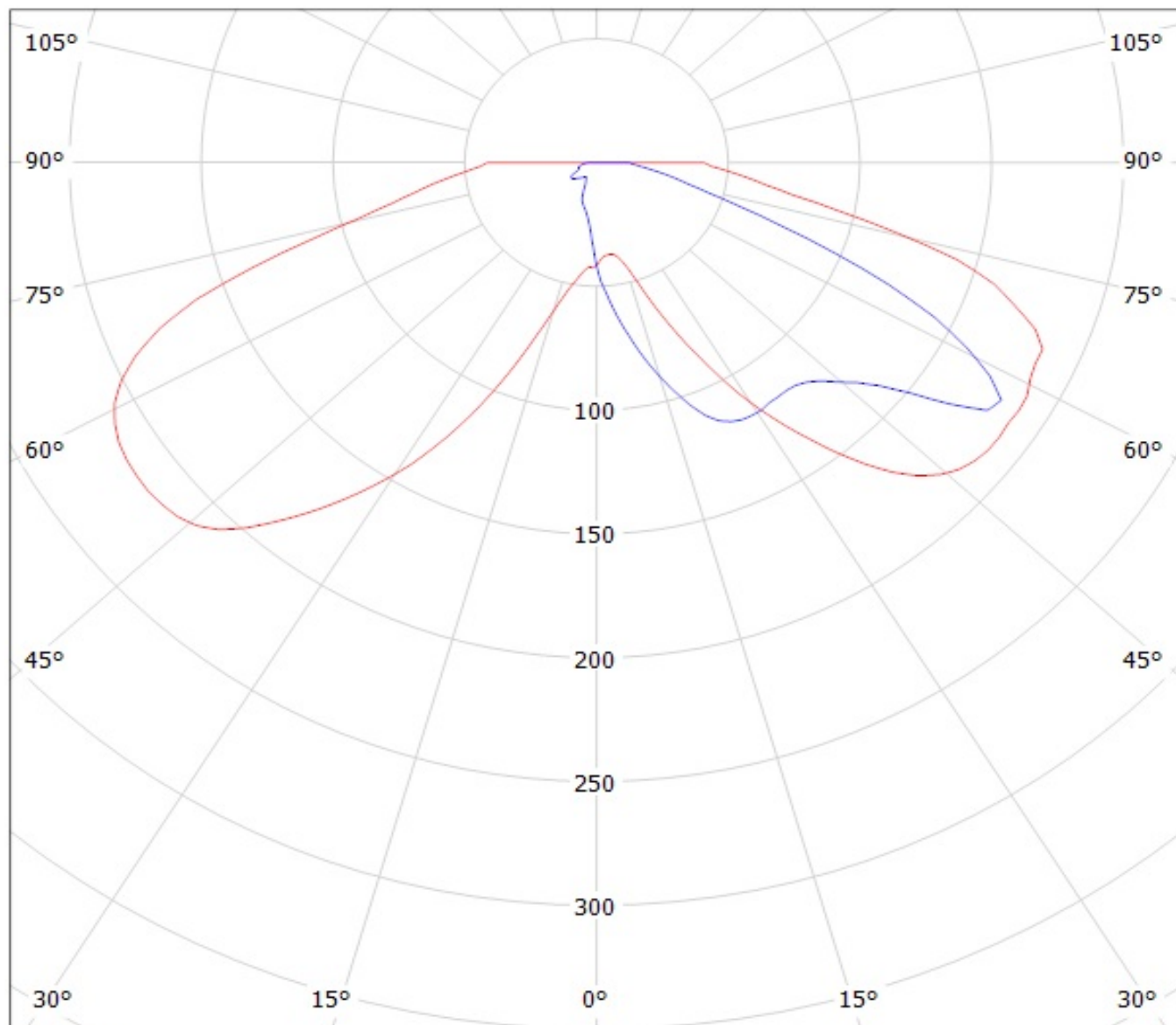

cd/klm

— C0 - C180

— C90 - C270

NOTE: The typical divergence will be changed by different color, chip size and chip position tolerance. The typical total divergence is the full angle measured where the luminous intensity is half of the peak value.