

SOT-23

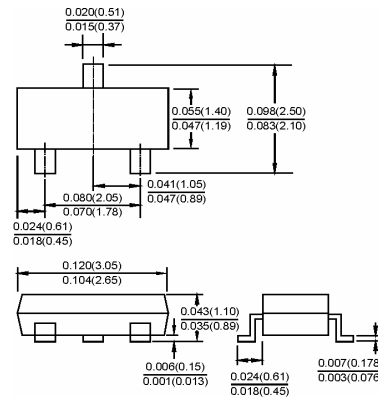

Features

- Two element incorporated into one package. (Emitter-coupled transistors)
- Reduction of the mounting area and assembly cost by one half.

Applications

- For general application.

Dimensions in inches and (millimeters)



MMBD1501A

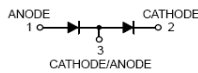

MMBD1503A

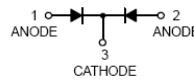

MMBD1504A

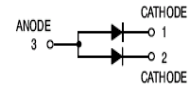

MMBD1505A

Ordering Information

Type No.	Marking	Package Code
MMBD1501A	A11	SOT-23
MMBD1503A	A13	SOT-23
MMBD1504A	A14	SOT-23
MMBD1505A	A15	SOT-23

MAXIMUM RATING @ Ta=25°C unless otherwise specified

Parameter	Symbol	Limits	Unit
Reverse Voltage	V_R	200	V
Average rectified current	$V_{F(AV)}$	200	mA
Forward Continuous Current	I_{FM}	600	mA
Peak forward current (1.0s) (1.0m)	I_{FSM}	1.0 2.0	A
Power Dissipation	P_d	350	mW
Thermal resistance, Junction to ambient	$R_{\theta JA}$	357	°C/W
Storage temperature	T_{STG}	-55-150	°C

ELECTRICAL CHARACTERISTICS @ Ta=25°C unless otherwise specified

Parameter	Symbol	Min.	Max.	Unit	Test Conditions
Reverse Breakdown Voltage	$V_{(BR)R1}$	200		V	$I_R=5\mu A$
Forward voltage	V_F	0.62	0.72	V	$I_F=1mA$
		0.72	0.83		$I_F=10mA$
		0.8	0.89		$I_F=50mA$
		0.83	0.93		$I_F=100mA$
		0.87	1.1		$I_F=200mA$
		0.9	1.15		$I_F=300mA$
Reverse current	I_R		1.0 10	nA	$V_R=125V$ $V_R=180V$
Diode Capacitance	C_D		4	pF	$V_R=0V, f=1MHz$

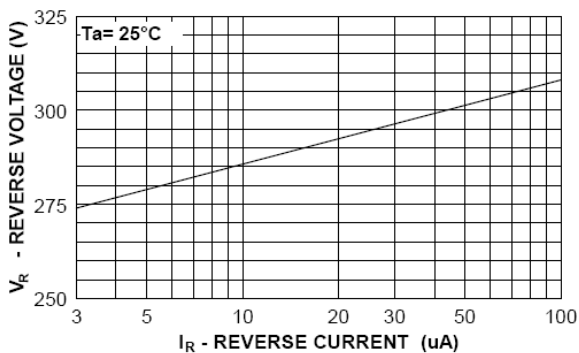
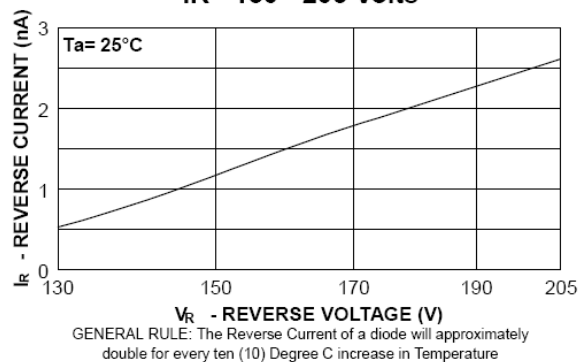
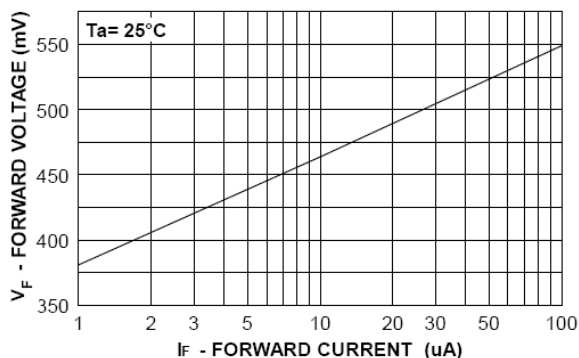
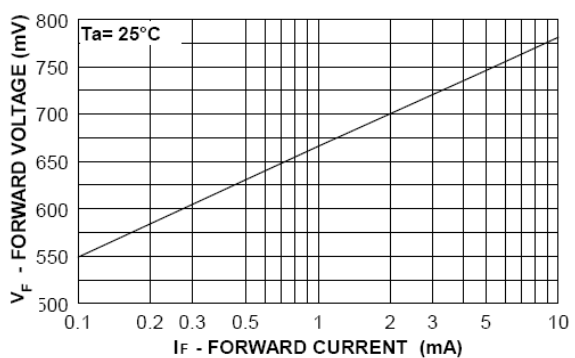
TYPICAL CHARACTERISTICS @ Ta=25°C unless otherwise specified
REVERSE VOLTAGE vs REVERSE CURRENT
BV - 3.0 to 100 uA

REVERSE CURRENT vs REVERSE VOLTAGE
IR - 130 - 205 Volts

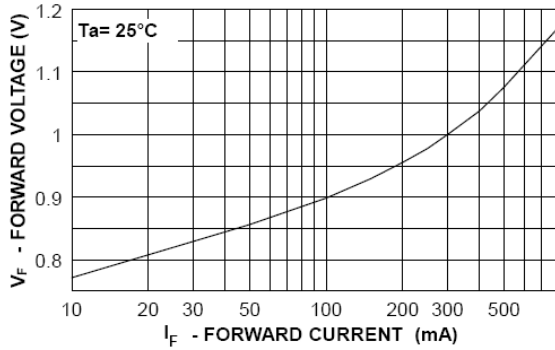
FORWARD VOLTAGE vs FORWARD CURRENT
VF - 1 to 100 uA

FORWARD VOLTAGE vs FORWARD CURRENT
VF - 0.1 to 10 mA

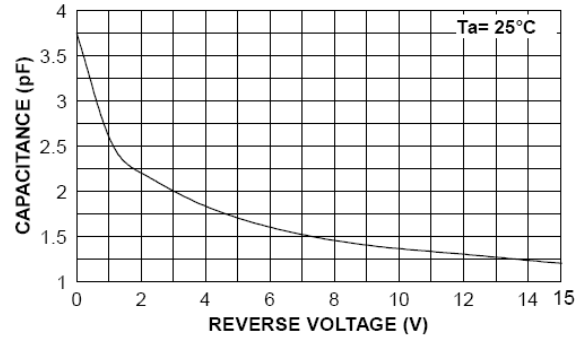
FORWARD VOLTAGE vs FORWARD CURRENT
VF - 10 to 800 mA



CAPACITANCE vs REVERSE VOLTAGE
VR - 0 to 15 V



Average Rectified Current (Io) & Forward Current (IF) versus Ambient Temperature (TA)

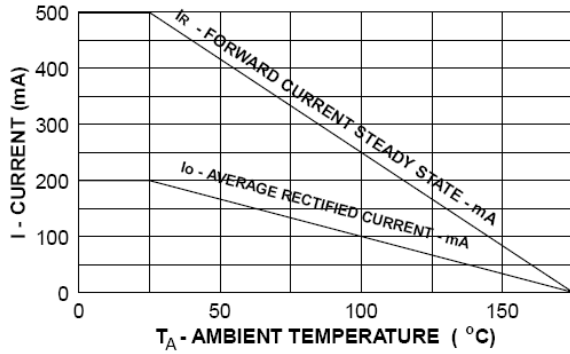

POWER DERATING CURVE

