

LF-A1-150H105A/C

Programmable IP67 Isolated LED Driver | Constant Current - Dimmable



Product family features

- 3-in-1 dimming + time dimming+12V AUX output (A version), 3-in-1 dimming + time dimming (C version)
- THD<10% @60% load, 230Vac
- Rated input voltage: 220-240Vac
- Ta: -40~+60°C
- Ripple current <3%
- Standby power consumption≤0.5W
- All-round protections: short-circuit, open-circuit, over-temperature
- IP67, suitable for Class I light fixtures
- 5 years guarantee



Product family benefits

- High efficiency
- Flicker free
- Long lifetime and high reliability
- Isolated

Typical applications

- For shoebox light, flood light, street light and tunnel light
- For street lighting

Product parameters

- Output current 300-1050mA
- Output power 21.6-150W
- Input voltage 180-264Vac
- Output voltage 72-214Vdc
- Efficiency 93%

Electrical data

Input data

Rated supply voltage	220 ... 240V
AC voltage range	180 ... 264V
Mains frequency	50Hz
Rated Input voltage DC	310 ... 340V
DC voltage range	254 ... 340V
Power factor	≥0.95/230Vac@full load
Current tolerance	Io≥600mA±5%; <600mA±35mA
Linear Adjustment Rate	±5%@full load
Load Adjustment Rate	Vo: 100-214Vdc ±5%; 72-214Vdc ±7%
Efficiency in max. power	92% ¹⁾
Input current	0.8A Max
Inrush current	80A ²⁾
Loading no. on circuit breaker 10 A (B)	4
Loading no. on circuit breaker 10 A (C)	6
Loading no. on circuit breaker 16 A (B)	6
Loading no. on circuit breaker 16 A (C)	10
Leakage current	≤0.7mA
Standby power consumption	≤0.5W@220Vac/50Hz Dim to off

Output data

Nominal output voltage	72 ... 214V
Nominal output current	300 ... 1050mA
Default output current	700mA
Current set	Programming
Maximum output power	150W Max@220-240Vac
Nominal output power	21.6 ... 150W
Output ripple current (100 Hz)	<3%@≤120Hz
Flicker	Comply with IEEE Std 1789-2015
CIE SVM	≤0.4
IEC-Pst	≤1
Temperature tolerance	±10%@25°C~60°C
Start-up time	230Vac <0.5S@full load
THD	≤10%@60% load Single harmonic: harmonic-C≥60% load/230Vac
Device power loss	/

12V AUX

Output Voltage	+12Vdc (11-14V)
Output Current	200mA max.
Dynamic Load	Please make sure that it matches the LED driver.
Ripple Voltage	≤1V

Safety

Withstanding voltage	I/P-O/P I/P-DIM+/DIM- : 3.75kV&5mA&60S ; I/P-PE DIM+/DIM-PE DIM+/DIM-O/P : 1.5kV&5mA&60S O/P-PE : 0.5kV&5mA&60S
Surge capability (L-N)	6 kV (2Ω)
Surge capability (L/N-Ground)	10 kV (12Ω)
Insulation resistance	I/P-PE I/P-O/P O/P-PE I/P-DIM+/DIM- DIM+/DIM-O/P DIM+/DIM-PE: >100MΩ@500VDC
Guarantee	5 years ³⁾

- 1) @output current 700mA, output voltage 214V, @230Vac
- 2) t =350μs
- 3) 5 years @Tc≤85°C

Characteristic diagram

Operating Window

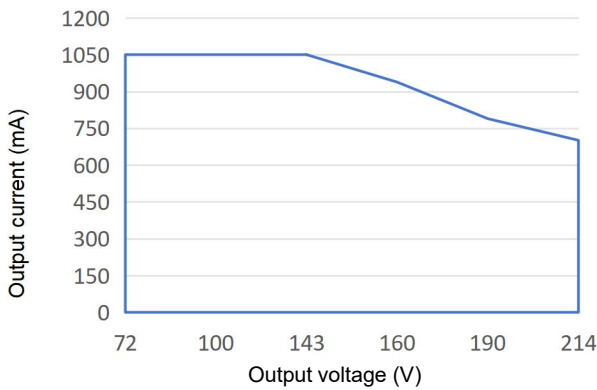

Typical Efficiency vs Load

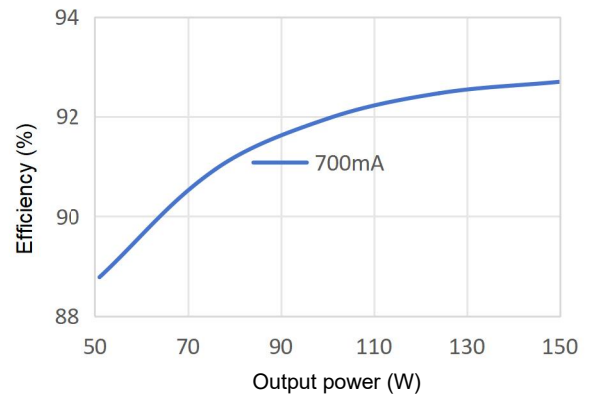

Typical Power Factor vs Load

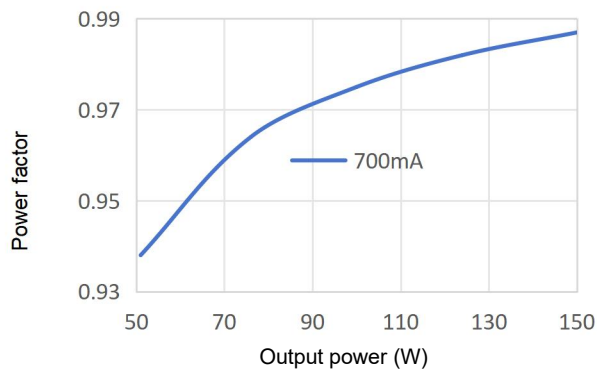

Typical THD vs Load

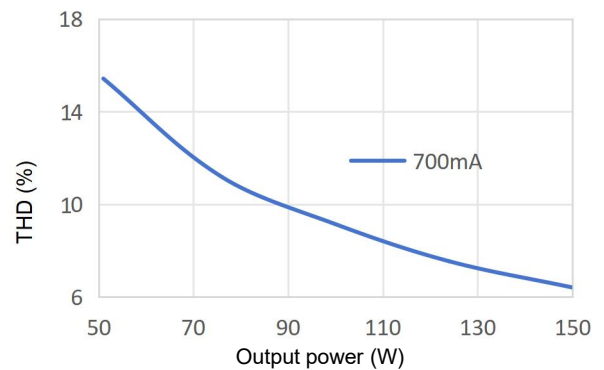

Load Derating Curve

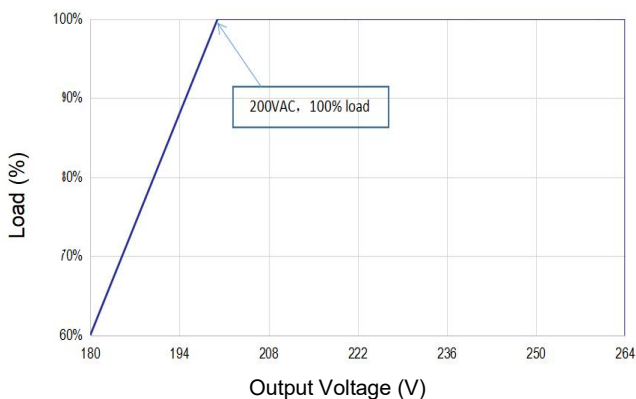

Lifespan

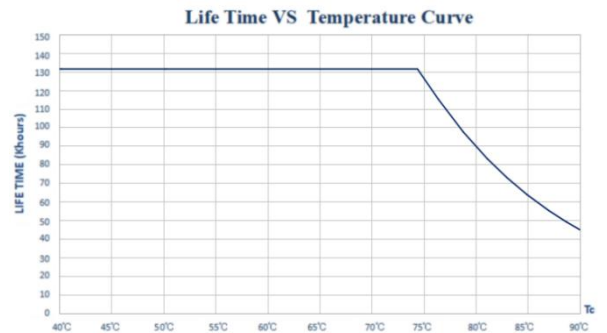

Note: input: 230Vac/50Hz, output: 214Vdc/700mA (only for reference)

Dimming Function Instruction

Parameter	Min.	Typ.	Max.	Note
Output current range set via programmer	300mA	700mA	1050mA	Total output power ≤150W

0-10V Dimming Operation

- Connect 0-10V signal to DIM terminal.
- In 0-10V dimming mode, when the input voltage is $0.8V \pm 0.15$, the light turns off; when it's $1.0V \pm 0.15$, the light turns on.
- Dimming depth: 10% (typical value)
- DIM+/- (without signal connected): 100% rated current output

Wiring Diagram of 0-10V Dimming

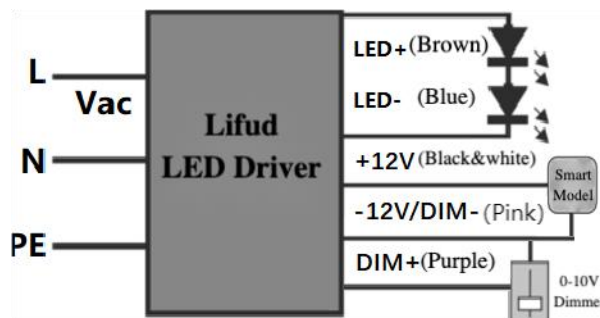

This diagram is only for A version; C version has no 12V+.

Dimming Curve

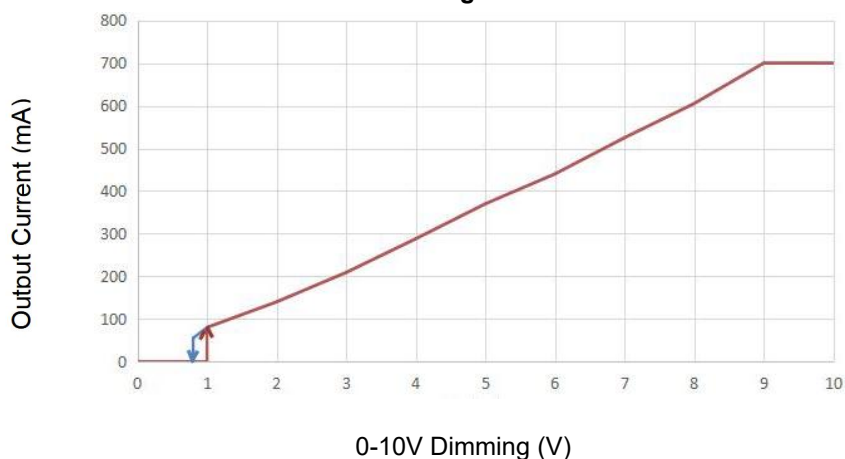

Input: 230Vac; output: 214Vdc/700mA (this data is measured by Lifud 0-10V dimmer and the chart is for reference only)

PWM Dimming Operation

- Connect PWM signal to the DIM terminal.
- Dimming depth: 10% (typical value)
- Compatible signal range: 1000-2000(Hz), amplitude: 9-10(V)
- DIM+/- (without signal connected): 100% rated current

Wiring Diagram of PWM Dimming

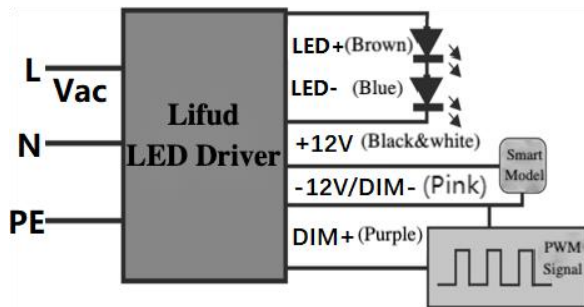

This diagram is only for A version; C version has no 12V+.

Dimming Curve

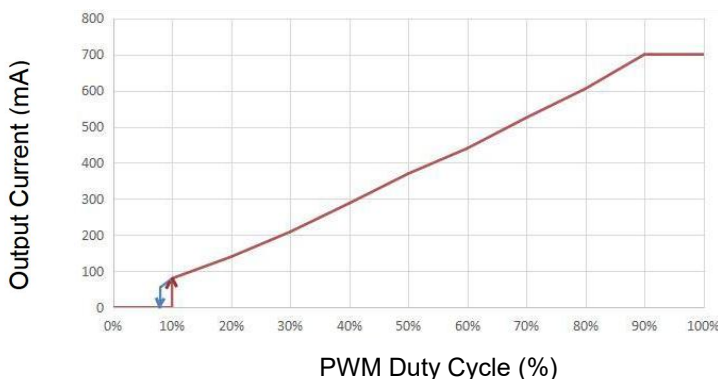

Input: 230Vac; output: 214Vdc/700mA (this data is measured by Lifud PWM signal generator RIGOL and the chart is for reference only)

Rx Dimming Operation

- Connect Rx signal to the DIM terminal.
- Range: 0-100KΩ
- DIM+/- (without signal connected): 100% rated current

Wiring Diagram of Rx Dimming

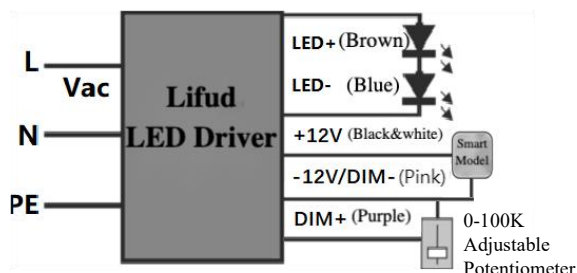

This diagram is only for A version; C version has no 12V+.

Dimming Curve

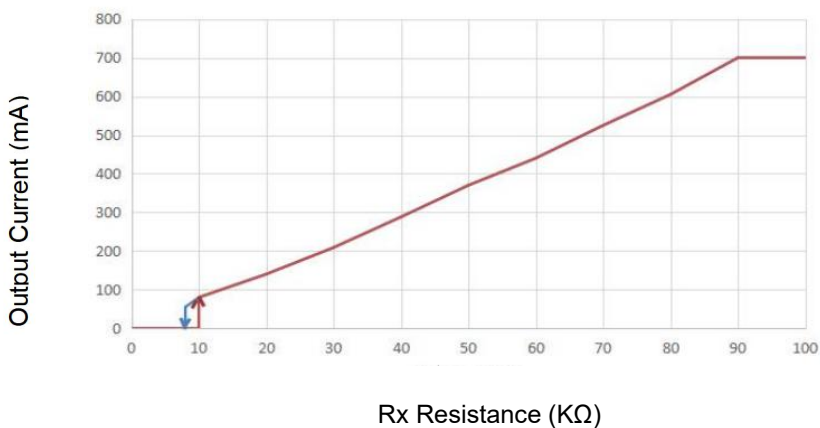

Input: 230Vac; output: 214Vdc/700mA (this data is measured by resistance dimmer and the chart is for reference only)

Programmer tools and software

Product	Name	Brand	Model	Software
	Lifud programmer	LIFUD	LF-SCS080C	LF-PRG

Wiring diagram of Rx dimming

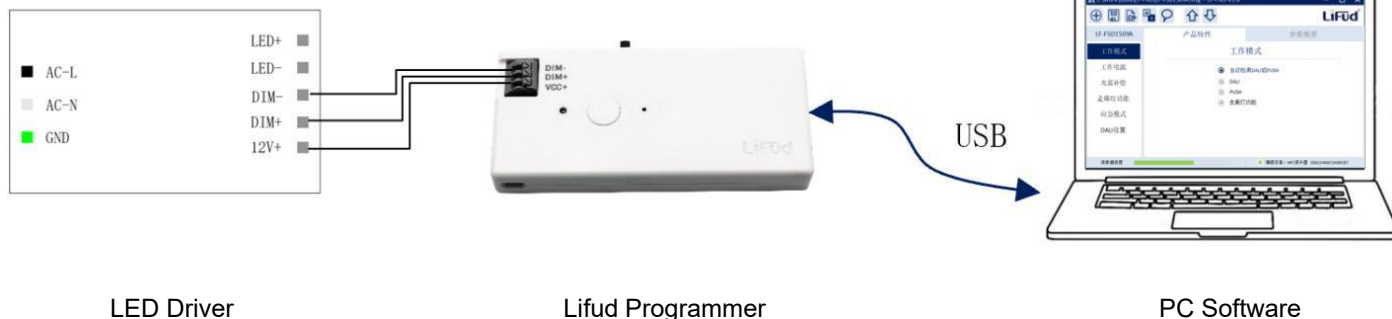

Time dimming function

Time dimming mode: there are 6 steps in total. You can set the brightness of each step and the operating time of the first to fifth steps.

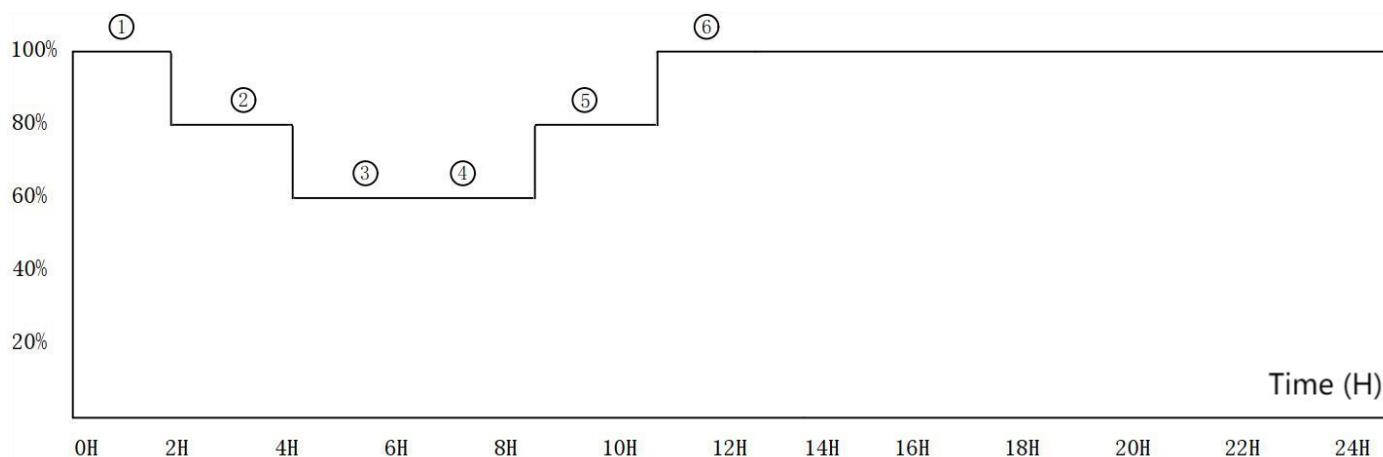

Note: In the time dimming mode, after the power is turned on, it will work according to the set dimming curve.

Dimensions

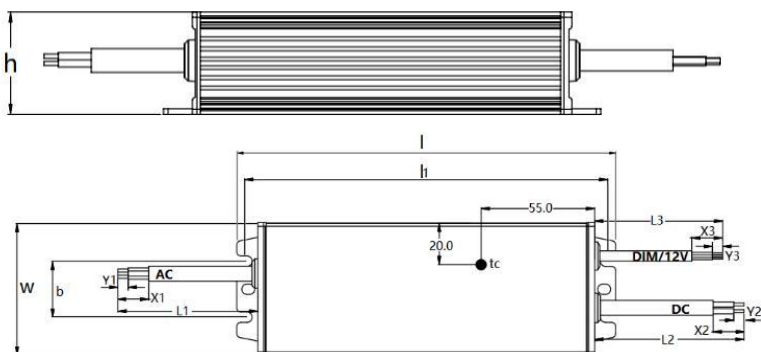

Note: this diagram is a front view and Tc point is on the front side of the driver.

Mounting hole spacing, length	173.6mm
Mounting hole spacing, width	27mm
Product weight	815g
Wire type, input side	3*1.0mm ² ϕ 8.2 \pm 1mm
Wire type, output side	2*1.0mm ² ϕ 7.7 \pm 1mm
Wire type, dimming and AUX side	3*22AWG ϕ 5.0 \pm 0.2mm
Wire color, input side	AC-L Brown; AC-N Blue; PE Yellow&green
Wire color, output side	LED+ Brown; LED- Blue
Wire color, dimming and AUX side	DIM+ Purple; DIM- Pink; +12V Black&white
Wire length, input side (L1)	270 \pm 10mm
Wire length, output side (L2)	230 \pm 10mm
Wire length, dimming and AUX side (L3)	220 \pm 10mm
Wire peeled length, input side (X1)	40 \pm 4mm
Wire peeled length, output side (X2)	36 \pm 3mm
Wire peeled length, dimming and AUX side (X3)	60 \pm 5mm
Wire tinned length, input side (Y1)	10 \pm 1.5mm
Wire tinned length, output side (Y2)	8 \pm 1.0mm
Wire tinned length, dimming and AUX side (Y3)	10 \pm 1.5mm
Length (l)	183.6 \pm 0.5mm
Width (w)	64.2 \pm 0.5mm
Height (h)	38 \pm 0.5mm

Colors & materials

Casing material	Metal
Casing color	Silver gray

Temperature & operating conditions

Ambient temperature range	-40°C - +60°C
Maximum temperature at Tc test point	90°C
Temperature range at storage	-40°C - +80°C (6 months in Class I environment)
Humidity range at storage	10-90%RH (no condensation)
Humidity during operation	20-90%RH
Atmospheric Pressure	86-106KPa
RoHS	RoHS 2.0 (EU) 2015/863

Capabilities

Dimmable	0-10V/PWM/Rx dimmable
Overload protection	/
Short-circuit protection	The LED driver will not be damaged even in the state of short circuit for a long time. (Auto-recovery)
Open-circuit protection	Open-circuit voltage $\leq 280\text{Vdc}$
Overheating protection	When Tc is $95^{\circ}\text{C} \pm 5^{\circ}\text{C}$, it will reduce the current and auto-recover when the Tc decreases to the normal temperature.
Max. cable length to lamp/LED module	/
Suitable for fixtures with prot. class	I
Control interface	/
Number of channels	1 channel

Programming

Programmer	LF-SCS080C
DALI Control Software	/
APP	LF-PRG

Certificates & standards

Approval marks – approval	ENEC, CE, CB, RCM, EAC
Standards	IEC/EN 61347-2-13, IEC/EN 61347-1, IEC/EN 62493 IEC/EN 62384, AS 61347.1, AS 61347.2.13
EMC	EN 55015, EN 61547, EN 61000-3-2,3
Group pulse	5kV (Class B)
ESD	Air 8kV, touch 4kV
Type of protection	IP67

Logistical Data

Product	Packaging unit (Pieces/Unit)	Dimensions (L*W*H)	Volume	Gross weight
LF-A1-150H105A/C	12	446mm*332mm*167mm	24.73dm ³	11.3kg±5%

Test equipment & condition

Test Equipment	AC power source: CHROMA6530, digital power meter: CHROMA66205, oscilloscope: Tektronix DPO3014, DC electronic load: M9712B, LED board, constant temperature and humidity chamber, lightning surge generator: Everfine EMS61000-5B, rapid group pulse generator: Everfine EMS61000-4A, spectroanalyzer: KH3935, hi-pot tester: EEC SE7440, flicker tester (flicker-free coefficient test): Everfine LFA-3000, etc.
-----------------------	---

If there are no special remarks, the above parameters are tested at the ambient temperature of 25°C, humidity of 50%, maximum output power and input voltage of 230Vac/50Hz.

Additional information

1. It is recommended that user install the over voltage protection, under voltage protection and surge protection devices in the power supply circuits of light fixtures to ensure electricity safety.

2. The LED driver used in combination with the end device is one of the accessories of the whole light fixture, and the EMC of the whole light fixture is not only susceptible to the driver itself, but to the LED light fixture and the whole light fixture's wiring. Thus, the manufacturer of LED light fixture should re-confirm the EMC of the whole light fixture before the whole light fixture is finished.

3. The test conditions of circuit breaker configuration quantity should be consistent with the ones of surge current.

4. The PC cover, casing and end cap for assembling the LED driver in the light fixture must meet the fire rating of UL94-V0 or above.

5. When using the LED driver, please pay attention that the total output power not exceed the maximum rated output power, otherwise the warranty service of LED driver would be failed.

6. When conducting withstanding voltage test on LED driver, please short-circuit the input wire L and N; the positive electrode and negative electrode of the output wire; the positive electrode and negative electrode of the dimming wire and AUX power supply.

Transportation & storage

Suitable transportation means: vehicles, boats and aeroplanes.

In transit, it is necessary to prepare awnings for rain or sun protection. Moreover, please keep civilized loading and unloading to prevent the vibration or impact of LED driver as much as possible.

The storage of LED driver shall conform to the standard of Class I environment. When using LED drivers which have been stored for more than 6 months, please re-test them firstly. Do not use them unless they are tested to be qualified.

Cautions

Please use Lifud LED driver according to its parameters in the specification, otherwise the LED driver may malfunction.

Using any incompatible light fixtures or those that have not been certified may cause fire, explosion or other risks.

Man-made damage is beyond the scope of Lifud warranty service.

Disclaimer

Subject to change without notice. Errors and omission excepted. Always make sure to use the most recent release.

Lifud Technology Co., Ltd. reserves the right to interpret any contents of this specification.