



■ Features

- Constant Current mode output
- Flicker free design
- Plastic housing with class II design
- Built-in active PFC function
- No load power consumption < 0.5W (Blank-Type)
- Function options: 2 in 1 dimming (dim-to-off); Auxiliary DC output
- 3 years warranty

■ Applications

- LED panel lighting
- LED flood lighting
- Indoor LED lighting

■ Description

IDLC-25 series is a 25W LED AC/DC driver featuring the constant current mode output with flicker free design. IDLC-25 operates from 90~295VAC and offers models with different rated current ranging between 350mA and 1050mA. Thanks to the efficiency up to 82%, with the fanless design, the entire series is able to operate for -20°C ~ +90°C case temperature under free air convection. IDLC-25 is equipped with various function options, such as dimming methodologies, so as to provide the optimal design flexibility for lighting system.

■ Model Encoding

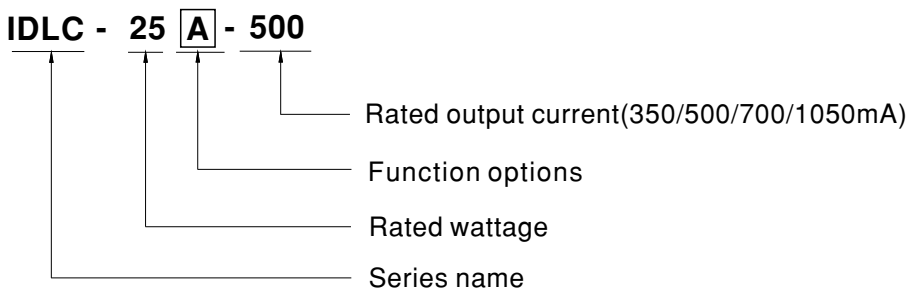

| Type | Function | Note |
|-------|--|----------|
| Blank | 2 in 1 dimming (0~10VDC and 10V PWM) | In Stock |
| A | 2 in 1 dimming and Auxiliary DC output | In Stock |

SPECIFICATION

| MODEL | | IDLC-25□-350 | IDLC-25□-500 | IDLC-25□-700 | IDLC-25□-1050 |
|--------------|--|---|--------------|--------------|---------------|
| OUTPUT | RATED CURRENT | 350mA | 500mA | 700mA | 1050mA |
| | RATED POWER | 24.5W | 25W | 25.2W | 25.2W |
| | CONSTANT CURRENT REGION <small>Note.2</small> | 49 ~ 70V | 35 ~ 50V | 25.2 ~ 36V | 16.8 ~ 24V |
| | OPEN CIRCUIT VOLTAGE _(max.) | 100V | 75V | 63V | 36V |
| | CURRENT RIPPLE | 5.0% max. @rated current | | | |
| | CURRENT TOLERANCE | ±7.0% | | | |
| | SETUP TIME <small>Note.4</small> | 500ms / 230VAC 1200ms/115VAC | | | |
| | AUXILIARY DC OUTPUT <small>Note.5</small> | Nominal 12V(deviation 11.4~12.6)@50mA for A-Type only | | | |
| INPUT | VOLTAGE RANGE <small>Note.3</small> | 90 ~ 295VAC (Please refer to "STATIC CHARACTERISTIC" section) | | | |
| | FREQUENCY RANGE | 47 ~ 63Hz | | | |
| | POWER FACTOR (Typ.) | PF>0.95/115VAC, PF>0.92/230VAC, PF>0.9/277VAC@full load (Please refer to "POWER FACTOR (PF) CHARACTERISTIC" section) | | | |
| | TOTAL HARMONIC DISTORTION | THD< 20%(@load≥70%/115VAC,230VAC; @load≥75%/277VAC) (Please refer to "TOTAL HARMONIC DISTORTION" section) | | | |
| | EFFICIENCY (Typ.) | 82% | 81.5% | 81.5% | 80% |
| | AC CURRENT | 0.4A/115VAC 0.16A/230VAC 0.13A/277VAC | | | |
| | INRUSH CURRENT (Typ.) | COLD START 30A(twidth=100μs measured at 50% Ipeak) at 230VAC; Per NEMA 410 | | | |
| | MAX. No. of PSUs on 16A CIRCUIT BREAKER | 32 units (circuit breaker of type B) / 32 units (circuit breaker of type C) at 230VAC | | | |
| | LEAKAGE CURRENT | <0.75mA / 277VAC | | | |
| | NO LOAD POWER CONSUMPTION | <0.5W for Blank-Type, <1.2W for A-Type | | | |
| PROTECTION | SHORT CIRCUIT | Hiccup mode, recovers automatically after fault condition is removed | | | |
| ENVIRONMENT | WORKING TEMP. | Tcase=-20 ~ +90°C (Please refer to " OUTPUT LOAD vs TEMPERATURE" section) | | | |
| | MAX. CASE TEMP. | Tcase=+90°C | | | |
| | WORKING HUMIDITY | 20 ~ 90% RH non-condensing | | | |
| | STORAGE TEMP., HUMIDITY | -40 ~ +80°C, 10 ~ 95% RH | | | |
| | TEMP. COEFFICIENT | ±0.03%/°C (0 ~ 45°C) | | | |
| | VIBRATION | 10 ~ 500Hz, 2G 10min./1cycle, period for 60min. each along X, Y, Z axes | | | |
| SAFETY & EMC | SAFETY STANDARDS | UL8750, CSA C22.2 NO.250.13-12;EN/AS/NZS 61347-1 & EN/AS/NZS 61347-2-13 independent, EN62384, GB19510.1,GB19510.14, BIS IS15885(for IDLC-25-700 only), EAC TP TC 004 approved | | | |
| | WITHSTAND VOLTAGE | I/P-O/P:3.75KVAC | | | |
| | ISOLATION RESISTANCE | I/P-O/P:100M Ohms / 500VDC / 25°C/ 70% RH | | | |
| | EMC EMISSION | Compliance to EN55015, EN61000-3-2 Class C (@load ≥ 70%) ; EN61000-3-3,GB17743,GB17625.1,EAC TP TC 020 | | | |
| | EMC IMMUNITY | Compliance to EN61000-4-2,3,4,5,6,8,11; EN61547, light industry level(surge immunity:Line-Line:1KV),EAC TP TC 020 | | | |
| OTHERS | MTBF | 418.9Khrs min. MIL-HDBK-217F (25°C) | | | |
| | DIMENSION | 110*75*22mm(L*W*H) | | | |
| | PACKING | 0.196Kg; 63pcs / 13.348Kg / 0.88CUFT | | | |
| NOTE | <p>1. All parameters NOT specially mentioned are measured at 230VAC input, rated current and 25°C of ambient temperature.</p> <p>2. Please refer to "DRIVING METHODS OF LED MODULE".</p> <p>3. De-rating may be needed under low input voltages. Please refer to "STATIC CHARACTERISTIC" sections for details.</p> <p>4. Length of set up time is measured at cold first start. Turning ON/OFF the driver may lead to increase of the set up time.</p> <p>5. Aux. 12V will be damaged with short circuit; It will not be available when output voltage is not in constant current region or output no load condition.</p> <p>6. The driver is considered as a component that will be operated in combination with final equipment. Since EMC performance will be affected by the complete installation, the final equipment manufacturers must re-qualify EMC Directive on the complete installation again.</p> <p>7. The ambient temperature derating of 3.5°C/1000m with fanless models and of 5°C/1000m with fan models for operating altitude higher than 2000m(6500ft).</p> <p>※ Product Liability Disclaimer : For detailed information, please refer to https://www.meanwell.com/serviceDisclaimer.aspx</p> | | | | |

■ **Block Diagram**

fosc : 70KHz

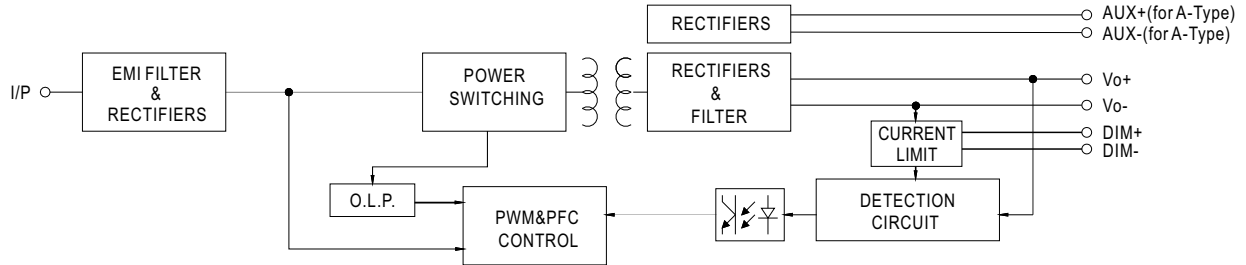

■ **DRIVING METHODS OF LED MODULE**

※ This series works in constant current mode to directly drive the LEDs.

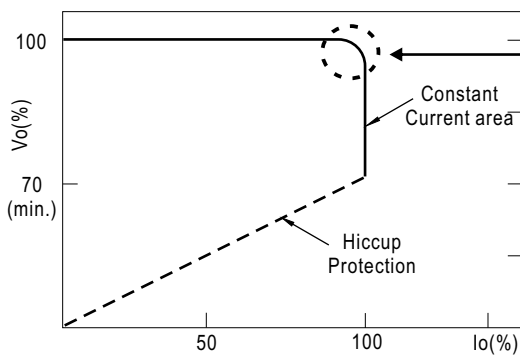

Typical output current normalized by rated current (%)

In the constant current region, the highest voltage at the output of the driver depends on the configuration of the end systems.
Should there be any compatibility issues, please contact MEAN WELL.

■ DIMMING OPERATION

※ 2 in 1 dimming function

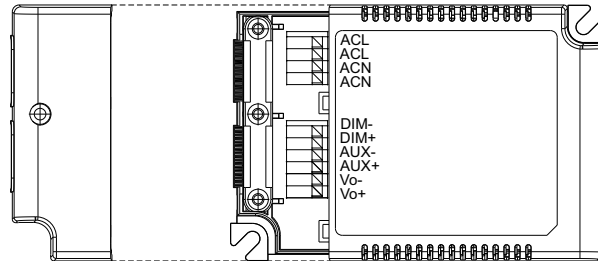

- Output constant current level can be adjusted by applying one of the two methodologies between DIM+ and DIM-: 0 ~ 10VDC, or 10V PWM signal.
- Direct connecting to LEDs is suggested. It is not suitable to be used with additional drivers.

◎ Applying additive 0 ~ 10VDC

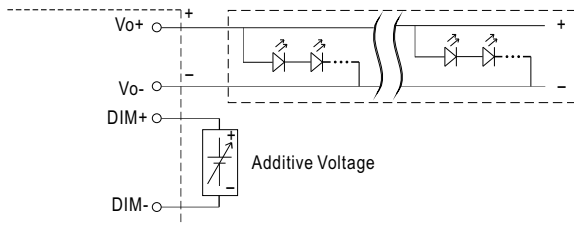

"DO NOT connect "DIM- to Vo-"

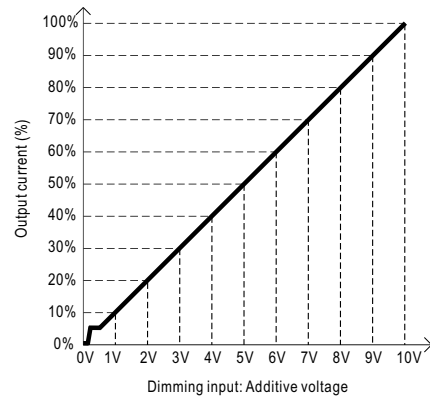

◎ Applying additive 10V PWM signal (frequency range 300Hz ~ 3KHz):

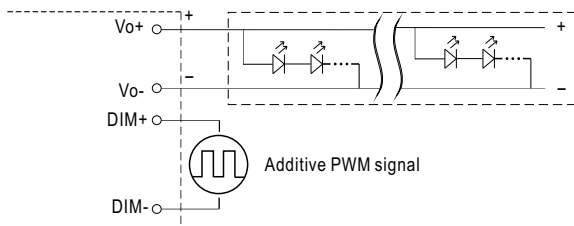

"DO NOT connect "DIM- to Vo-"

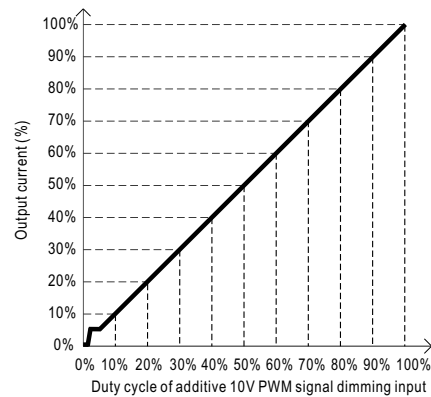

- Note : 1. Min. dimming level is about 8% and the output current is not defined when $0\% < I_{out} < 8\%$.
 2. The output current could drop down to 0% when dimming input is about 0Vdc or 10V PWM signal with 0% duty cycle.

OUTPUT LOAD vs TEMPERATURE

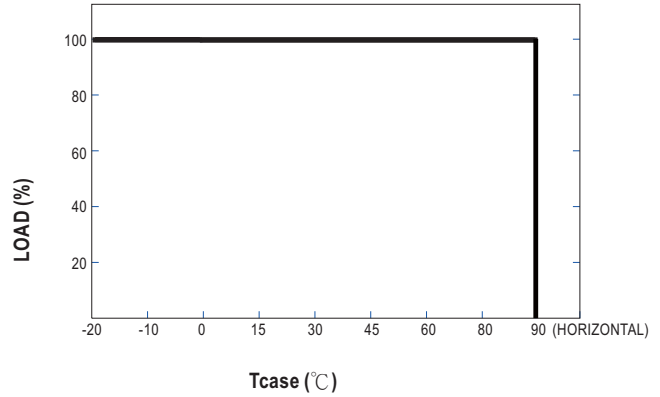
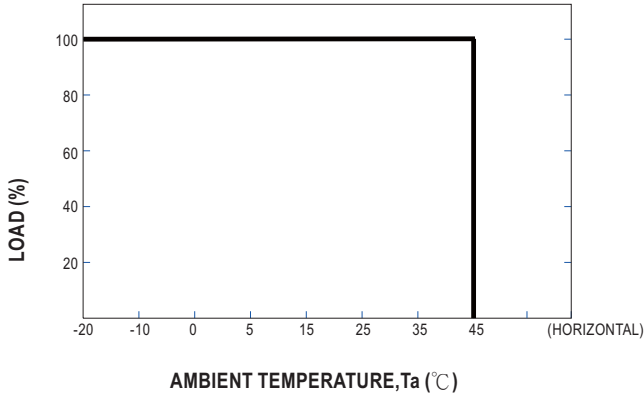

STATIC CHARACTERISTIC

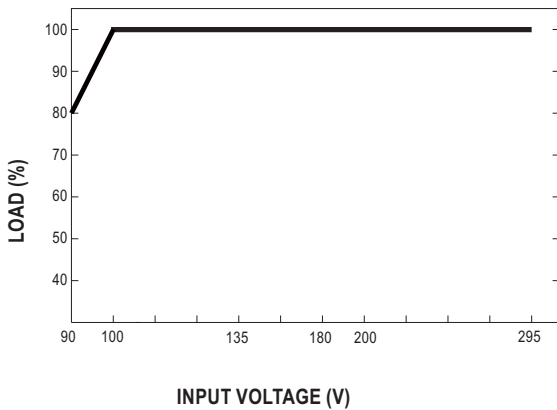

※ De-rating is needed under low input voltage.

POWER FACTOR (PF) CHARACTERISTIC

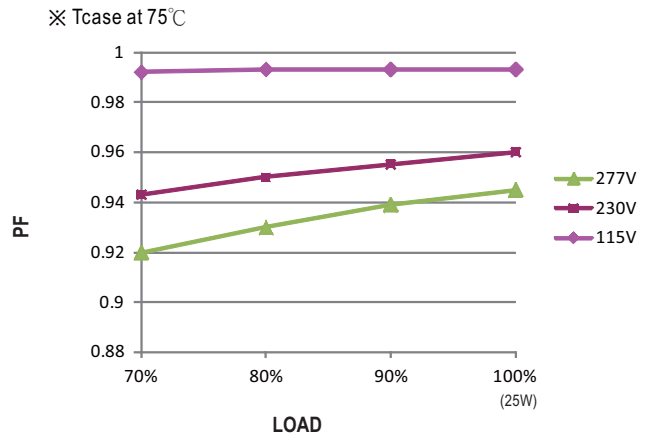

TOTAL HARMONIC DISTORTION (THD)

※ 350mA Model, Tcase at 75°C

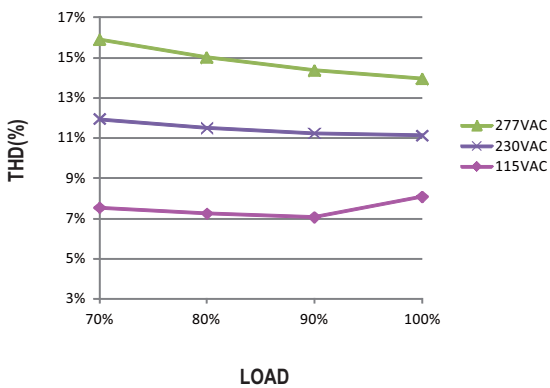

EFFICIENCY vs LOAD

IDLC-25 series possess superior working efficiency that up to 82% can be reached in field applications.

※ 350mA Model, Tcase at 75°C

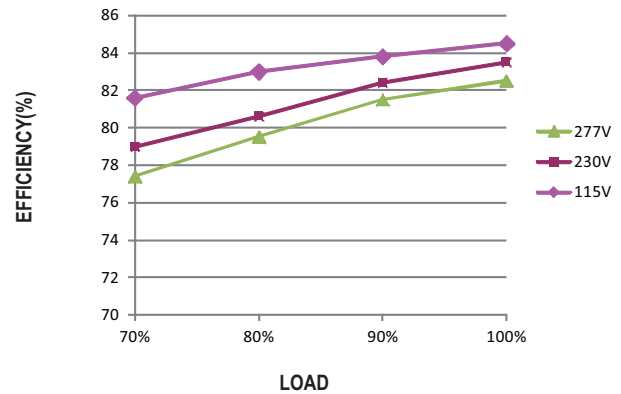

MECHANICAL SPECIFICATION

Case No. IDLC-25A Unit:mm

※ Blank-Type

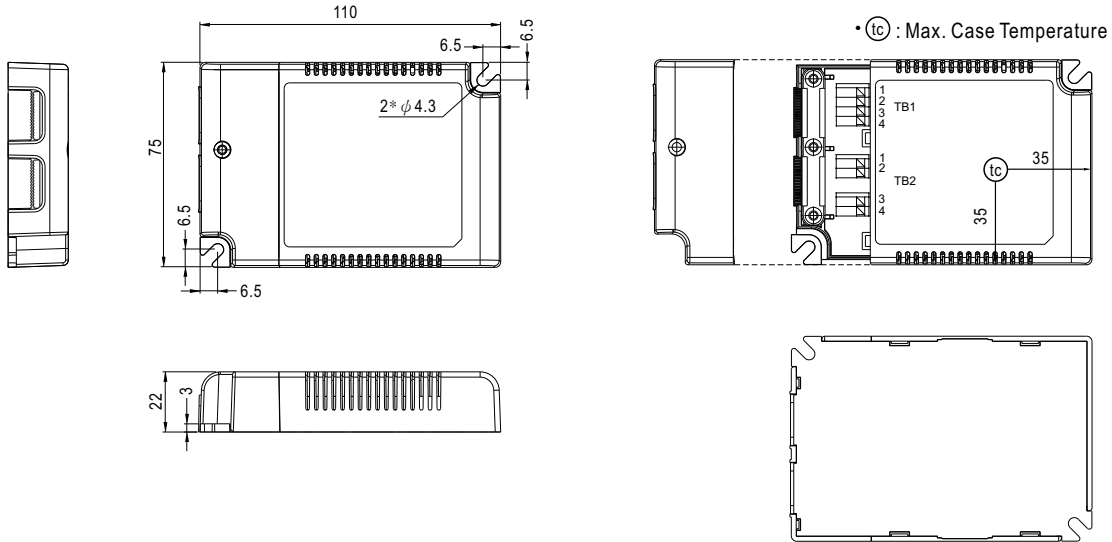

NOTE: Please use wires with a cross section of 0.75~1.5mm² for TB1 and wires with a cross section of 0.5~1.5mm² for TB2.

Terminal Pin No. Assignment(TB1)

| Pin No. | Assignment |
|---------|------------|
| 1 | ACL |
| 2 | ACL |
| 3 | ACN |
| 4 | ACN |

Terminal Pin No. Assignment(TB2)

| Pin No. | Assignment |
|---------|------------|
| 1 | DIM- |
| 2 | DIM+ |
| 3 | Vo- |
| 4 | Vo+ |

※ A-Type

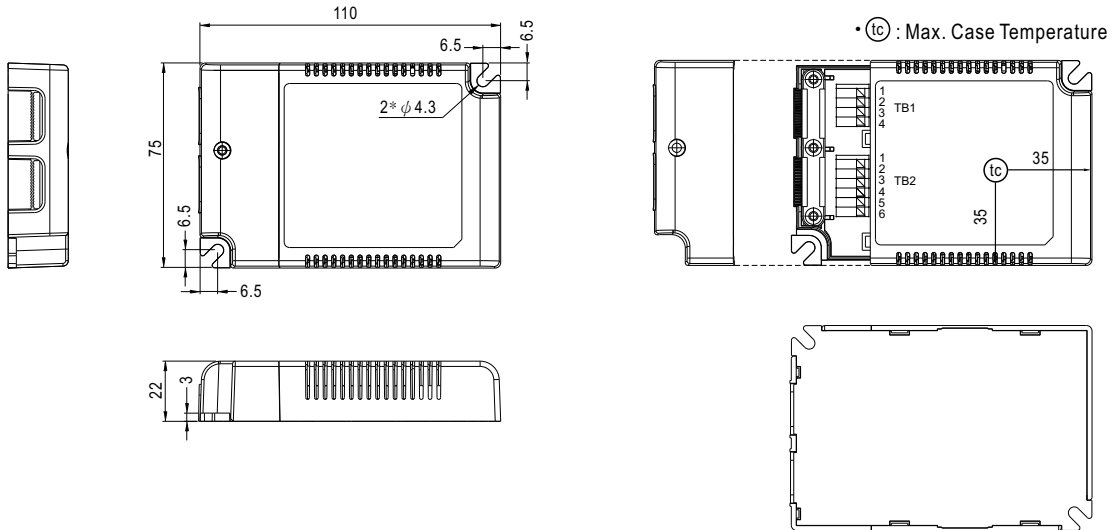

NOTE: Please use wires with a cross section of 0.75~1.5mm² for TB1 and wires with a cross section of 0.5~1.5mm² for TB2.

Terminal Pin No. Assignment(TB1)

| Pin No. | Assignment |
|---------|------------|
| 1 | ACL |
| 2 | ACL |
| 3 | ACN |
| 4 | ACN |

Terminal Pin No. Assignment(TB2)

| Pin No. | Assignment | Pin No. | Assignment |
|---------|------------|---------|------------|
| 1 | DIM- | 4 | AUX+ |
| 2 | DIM+ | 5 | Vo- |
| 3 | AUX- | 6 | Vo+ |

■ Installation Manual

Please refer to : <http://www.meanwell.com/manual.html>