

**■ Features**

- Constant Current mode output
- Flicker free design
- Plastic housing with class II design
- Built-in active PFC function
- No load power consumption<0.5W(Blank-Type), Standby power consumption<0.5W(DA-Type)
- Function options: 2 in 1 dimming (dim-to-off); Auxiliary DC output; DALI
- 3 years warranty

**■ Applications**

- LED panel lighting
- LED flood lighting
- Indoor LED lighting

**■ Description**

IDLC-45 series is a 45W LED AC/DC driver featuring the constant current mode output with flicker free design. IDLC-45 operates from 90~295VAC and offers models with different rated current ranging between 350mA and 1400mA. Thanks to the efficiency up to 86%, with the fanless design, the entire series is able to operate for -20°C~+85°C case temperature under free air convection. IDLC-45 is equipped with various function options, such as dimming methodologies, so as to provide the optimal design flexibility for lighting system.

**■ Model Encoding**

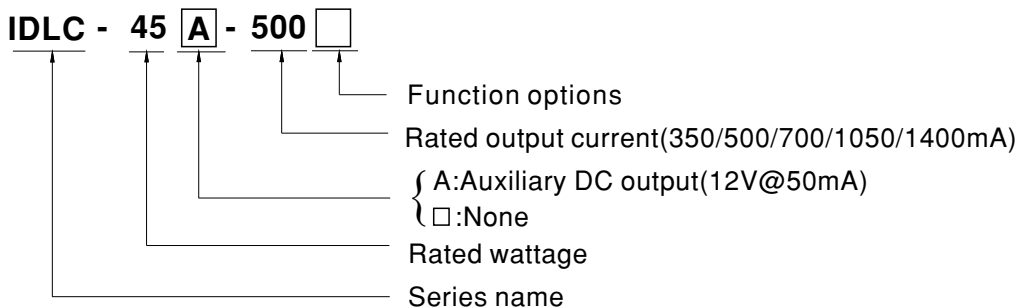

Type	Function	Note
Blank	2 in 1 dimming (0~10VDC and 10V PWM)	In Stock
DA	DALI control technology	In Stock

Note: The DALI control model(DA Type) only for IDLC-45 Non Auxiliary DC output models.

**SPECIFICATION**

MODEL		IDLC-45□-350□	IDLC-45□-500□	IDLC-45□-700□	IDLC-45□-1050□	IDLC-45□-1400□
OUTPUT	RATED CURRENT	350mA	500mA	700mA	1050mA	1400mA
	RATED POWER	33.25W	45W	44.8W	45.15W	44.8W
	CONSTANT CURRENT REGION <small>Note.2</small>	57 ~ 95V	54 ~ 90V	38 ~ 64V	26 ~ 43V	19 ~ 32V
	OPEN CIRCUIT VOLTAGE <sub>(max.)</sub>	118V	115V	84V	63V	50V
	CURRENT RIPPLE	5% max. @rated current				
	CURRENT TOLERANCE	±7.0%				
	SETUP TIME <small>Note.4</small>	500ms / 230VAC 1200ms/115VAC				
	AUXILIARY DC OUTPUT <small>Note.5</small>	Nominal 12V(deviation 11.4~12.6)@50mA for IDLC-45A only				
INPUT	VOLTAGE RANGE <small>Note.3</small>	90 ~ 295VAC (Please refer to "STATIC CHARACTERISTIC" section)				
	FREQUENCY RANGE	47 ~ 63Hz				
	POWER FACTOR (Typ.)	PF>0.95/115VAC, PF>0.92/230VAC, PF>0.9/277VAC@full load (Please refer to "POWER FACTOR (PF) CHARACTERISTIC" section)				
	TOTAL HARMONIC DISTORTION	THD< 20%(@load≥60%/115VAC,230VAC; @load≥75%/277VAC) (Please refer to "TOTAL HARMONIC DISTORTION" section)				
	EFFICIENCY (Typ.)	86%	85%	85%	84%	83%
	AC CURRENT	0.6A/115VAC 0.4A/230VAC 0.3A/277VAC				
	INRUSH CURRENT (Typ.)	COLD START 30A(twidth=100μs measured at 50% Ipeak) at 230VAC; Per NEMA 410				
	MAX. No. of PSUs on 16A CIRCUIT BREAKER	32 units (circuit breaker of type B) / 32 units (circuit breaker of type C) at 230VAC				
	LEAKAGE CURRENT	<0.75mA / 277VAC				
	NO LOAD/STANDBY POWER CONSUMPTION	No load power consumption<0.5W for Blank-Type,<1.2W for IDLC-45A Standby power consumption<0.5W for DA-Type				
PROTECTION	SHORT CIRCUIT	Hiccup mode,auto-recovery after fault condition is removed for DA type; Hiccup mode,re-power on to recovery for other type				
ENVIRONMENT	WORKING TEMP.	Tcase=-20 ~ +85°C (Please refer to " OUTPUT LOAD vs TEMPERATURE" section)				
	MAX. CASE TEMP.	Tcase=+85°C				
	WORKING HUMIDITY	20 ~ 90% RH non-condensing				
	STORAGE TEMP., HUMIDITY	-40 ~ +80°C, 10 ~ 95% RH				
	TEMP. COEFFICIENT	±0.03%/°C (0 ~ 40°C)				
	VIBRATION	10 ~ 500Hz, 2G 10min./1cycle, period for 60min. each along X, Y, Z axes				
SAFETY & EMC	SAFETY STANDARDS	UL8750, CSA C22.2 NO.250.13-12;EN61347-1 & EN61347-2-13 independent, AS/NZS 61347-1 & AS/NZS 61347-2-13 independent(except for DA-type),EN62384,GB19510.1,GB19510.14, BIS IS15885(for IDLC-45-500,500DA,700,700DA,1050,1050DA only), EAC TP TC 004 approved				
	DALI STANDARDS	Compliance to IEC62386-101, 102 for DA-Type only				
	WITHSTAND VOLTAGE	I/P-O/P:3.75KVAC				
	ISOLATION RESISTANCE	I/P-O/P:100M Ohms / 500VDC / 25°C/ 70% RH				
	EMC EMISSION	Compliance to EN55015, EN61000-3-2 Class C (@load ≥ 60%) ; EN61000-3-3,GB17743,GB17625.1,EAC TP TC 020				
	EMC IMMUNITY	Compliance to EN61000-4-2,3,4,5,6,8,11; EN61547, light industry level(surge immunity:Line-Line:1KV),EAC TP TC 020				
OTHERS	MTBF	408.8Khrs min. MIL-HDBK-217F (25°C)				
	DIMENSION	120*75*25mm(L*W*H)				
	PACKING	0.22Kg; 54pcs/ 13Kg/ 0.93CUFT				
NOTE	<ol style="list-style-type: none"> <li>All parameters NOT specially mentioned are measured at 230VAC input, rated current and 25°C of ambient temperature.</li> <li>Please refer to "DRIVING METHODS OF LED MODULE".</li> <li>De-rating may be needed under low input voltages. Please refer to "STATIC CHARACTERISTIC" sections for details.</li> <li>Length of set up time is measured at cold first start. Turning ON/OFF the driver may lead to increase of the set up time.</li> <li>Aux. 12V will be damaged with short circuit; it will not be available when output voltage is not in constant current region or output no load condition.</li> <li>The driver is considered as a component that will be operated in combination with final equipment. Since EMC performance will be affected by the complete installation, the final equipment manufacturers must re-qualify EMC Directive on the complete installation again.</li> <li>The DALI version driver does not support the bit 1: Lamp failure in the Command 144 Query status of the DALI standard.</li> <li>The ambient temperature derating of 3.5°C/1000m with fanless models and of 5°C/1000m with fan models for operating altitude higher than 2000m(6500ft).</li> </ol> <p>※ Product Liability Disclaimer : For detailed information, please refer to <a href="https://www.meanwell.com/serviceDisclaimer.aspx">https://www.meanwell.com/serviceDisclaimer.aspx</a></p>					

■ Block Diagram

fosc : 70KHz

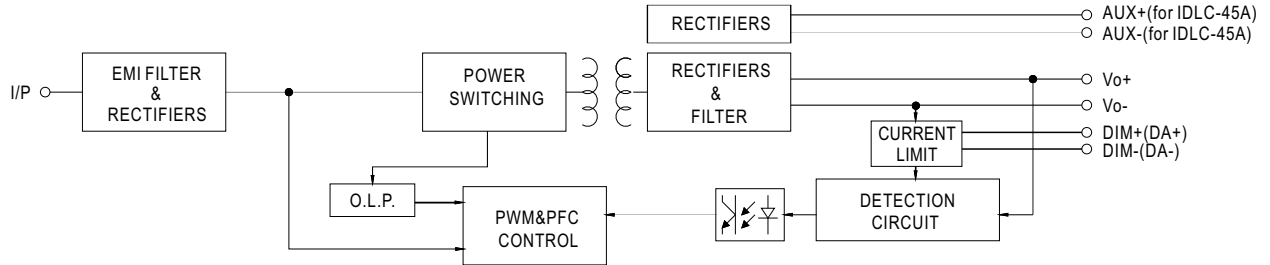

■ DRIVING METHODS OF LED MODULE

※ This series works in constant current mode to directly drive the LEDs.

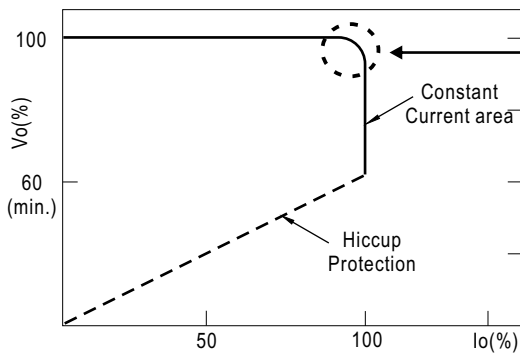

Typical output current normalized by rated current (%)

In the constant current region, the highest voltage at the output of the driver depends on the configuration of the end systems.  
Should there be any compatibility issues, please contact MEAN WELL.

**■ DIMMING OPERATION**

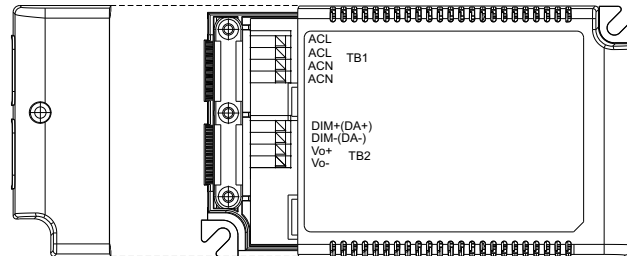

※ **2 in 1 dimming function**

- Output constant current level can be adjusted by applying one of the two methodologies between DIM+ and DIM-: 0 ~ 10VDC, or 10V PWM signal.
- Direct connecting to LEDs is suggested. It is not suitable to be used with additional drivers.

◎ Applying additive 0 ~ 10VDC

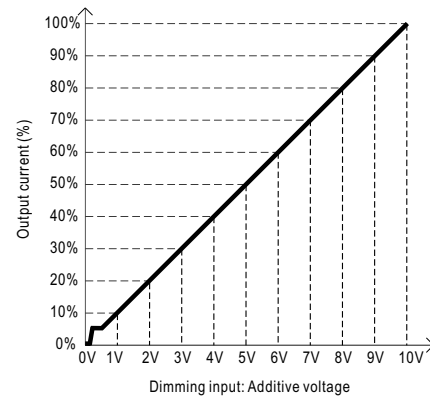
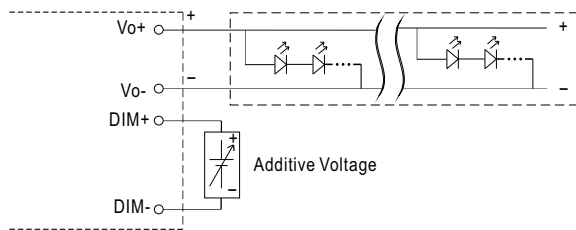

◎ Applying additive 10V PWM signal (frequency range 300Hz ~ 3KHz):

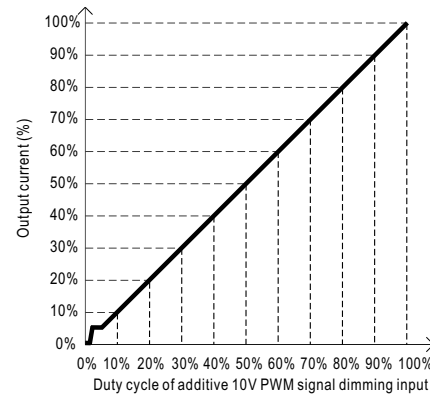
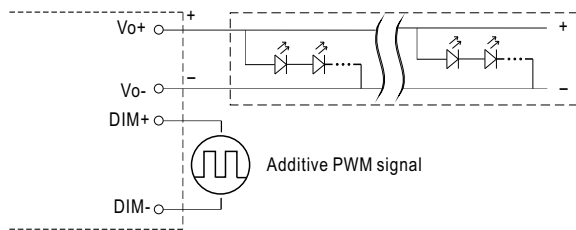

※ **DALI Interface (primary side; for DA-Type)**

- Apply DALI signal between DA+ and DA-.
- DALI protocol comprises 16 groups and 64 addresses.
- First step is fixed at 8% of output.

Note : 1. Min. dimming level is about 8% and the output current is not defined when  $0% < I_{out} < 8%$ .  
 2. The output current could drop down to 0% when dimming input is about 0Vdc or 10V PWM signal with 0% duty cycle.

**OUTPUT LOAD vs TEMPERATURE**

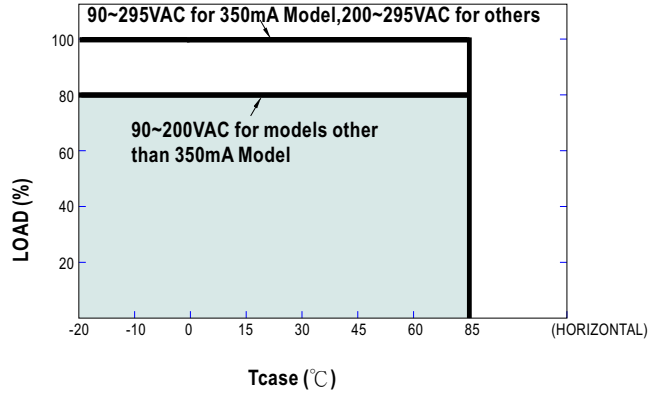
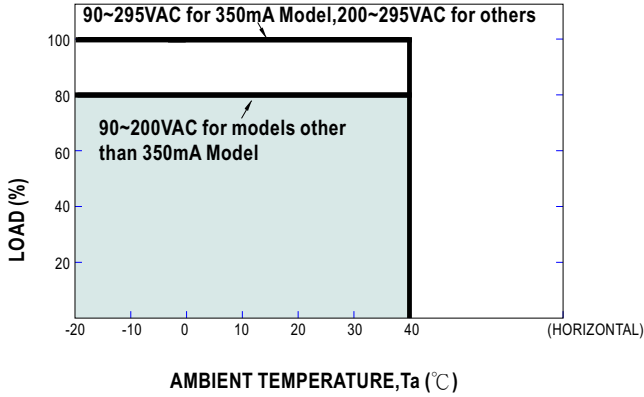

**STATIC CHARACTERISTIC**

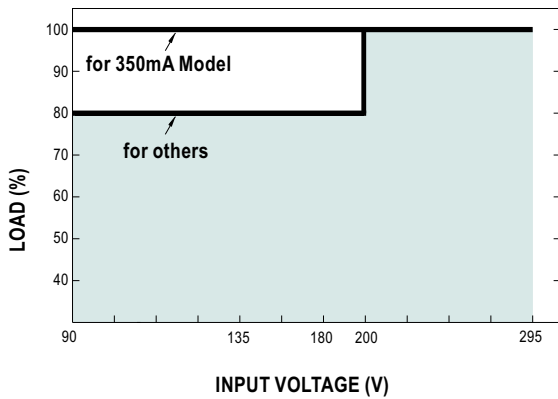

※ De-rating is needed under low input voltage.

**POWER FACTOR (PF) CHARACTERISTIC**

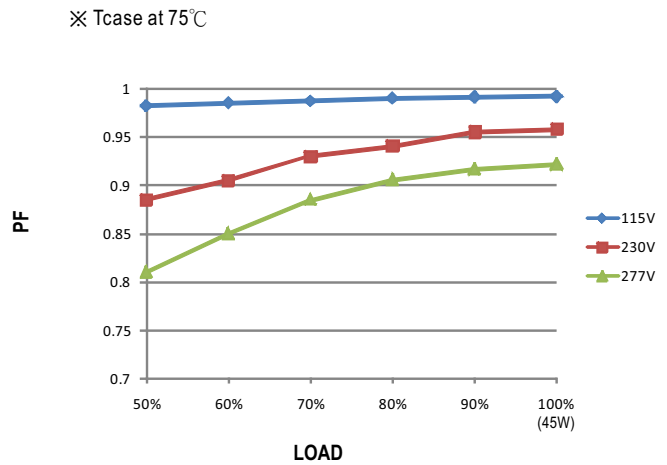

**TOTAL HARMONIC DISTORTION (THD)**

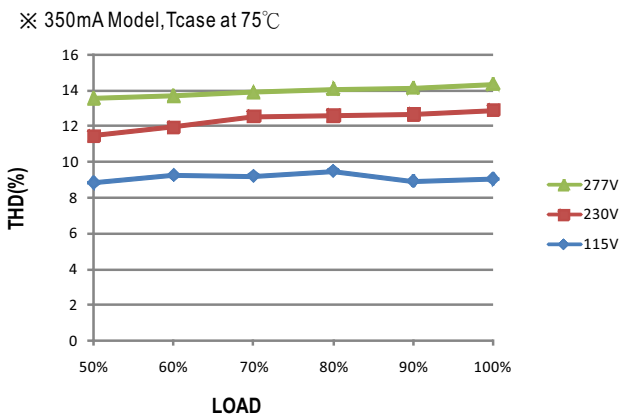

**EFFICIENCY vs LOAD**

IDLC-45 series possess superior working efficiency that up to 86% can be reached in field applications.

※ 350mA Model, Tcase at 75°C

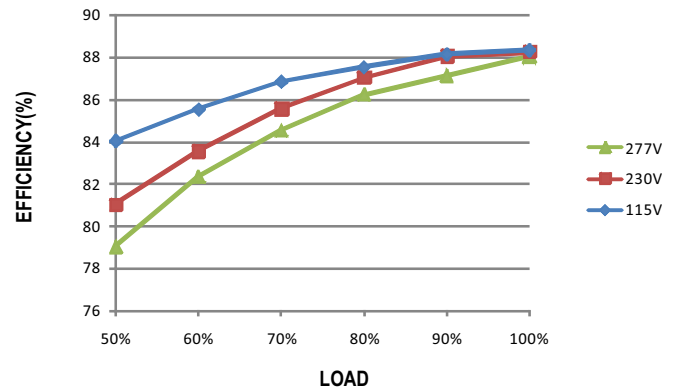

MECHANICAL SPECIFICATION

Case No.IDLC-45A Unit:mm

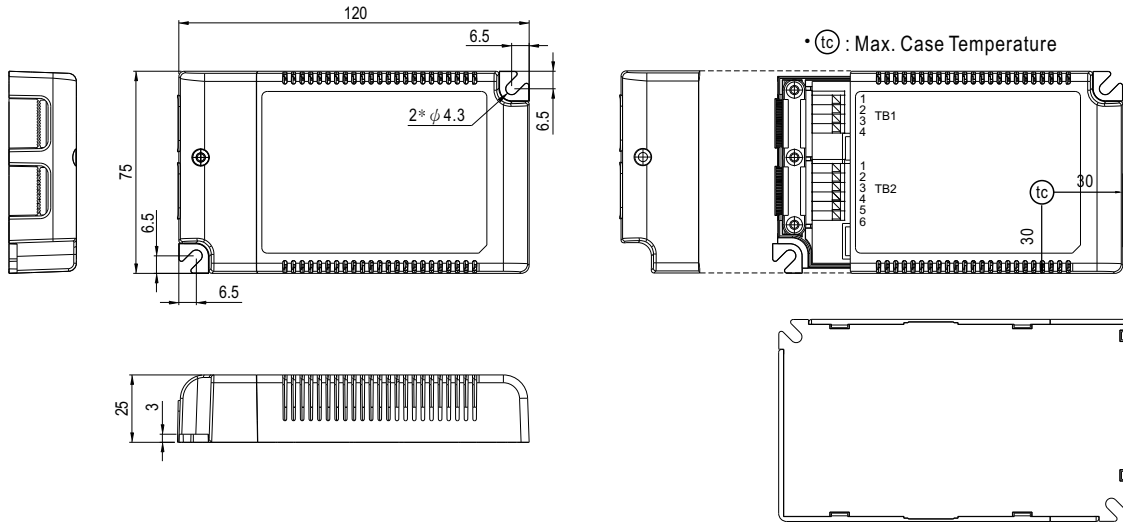

NOTE: Please use wires with a cross section of 0.75~1.5mm<sup>2</sup> for TB1 and wires with a cross section of 0.5~1.5mm<sup>2</sup> for TB2.

Terminal Pin No. Assignment(TB1)

Pin No.	Assignment
1	ACL
2	ACL
3	ACN
4	ACN

IDLC-45 Terminal Pin No. Assignment(TB2)

Pin No.	Assignment
1	DIM+(DA+)
2	DIM-(DA-)
3	Vo+
4	Vo-

IDLC-45A Terminal Pin No. Assignment(TB2)

Pin No.	Assignment	Pin No.	Assignment
1	DIM+	4	Vo-
2	DIM-	5	AUX+
3	Vo+	6	AUX-

Installation Manual

Please refer to :<http://www.meanwell.com/manual.html>