

■ **Features**

- Universal AC input / Full range
- 3.3"x2" compact PCB size
- Models with L-Bracket and cover available (PSC-35x-C, x=A,B)
- Protections: Short circuit / Overload / Over voltage
- Battery low protection / Battery reverse polarity protection by fuse
- Alarm signal for AC OK and Battery low
- Cooling by free air convection
- 100% full load burn-in test
- 2 years warranty

■ **Applications**

- Security system
- Emergency lighting system
- Alarm system
- UPS system
- Central monitoring system
- Access systems

■ **Description**

PSC-35 series is a 35W AC/DC security power supply, allowing the universal input range between 90VAC and 264VAC and incorporating the built-in PFC function. In addition to the primary output, there is a charger output, with a smaller rated current, providing the backup application the security access systems normally need.

PSC-35 delivers an efficiency up to 86%; it can operate with air convection under -30°C through 70°C. This series is designed with thorough alarm features, including AC OK and battery low signaling; moreover, the relay contact is provided to facilitate users' system designs. PSC-35 is available in the PCB type (3.3" x 2") or the enclosed type with L-Bracket and cover.

■ **Model Encoding**

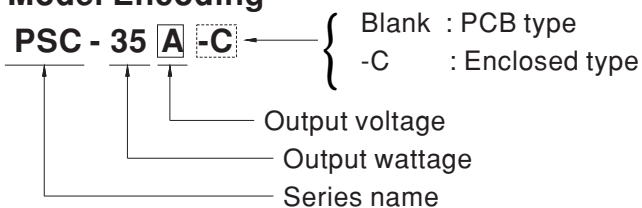



# 35W Single Output with Battery Charger(UPS Function)

# PSC-35 series

PSC-35A   =Blank, -C ; Blank=PCB only, -C=Enclosed type

## SPECIFICATION

| MODEL                 |  | PSC-35A <input type="checkbox"/>  |              | PSC-35B <input type="checkbox"/> |       |
|-----------------------|--|---|--------------|----------------------------------|-------|
| OUTPUT                | OUTPUT NUMBER  | CH1   | CH2          | CH1                              | CH2   |
|                       | DC VOLTAGE   | 13.8V   | 13.8V        | 27.6V                            | 27.6V |
|                       | RATED CURRENT  | 1.7A  | 0.9A         | 0.85A                            | 0.45A |
|                       | CURRENT RANGE  | 0 ~ 2.6A  | -----        | 0 ~ 1.3A                         | ----- |
|                       | RATED POWER  | 35.88W  |              | 35.88W                           |       |
|                       | RIPPLE & NOISE (max.) Note.2   | 120mVp-p  | -----        | 240mVp-p                         | ----- |
|                       | VOLTAGE ADJ. RANGE   | CH1: 12 ~ 15V   |              | CH1: 24 ~ 29V                    |       |
|                       | VOLTAGE TOLERANCE Note.3   | ± 1.0%  | -----        | ± 1.0%                           | ----- |
|                       | LINE REGULATION  | ± 0.5%  | -----        | ± 0.5%                           | ----- |
|                       | LOAD REGULATION  | ± 0.5%  | -----        | ± 0.5%                           | ----- |
|                       | SETUP, RISE TIME Note.4  | 800ms, 50ms/230VAC 1600ms, 50ms/115VAC at full load   |              |                                  |       |
| HOLD UP TIME (Typ.)   | 50ms/230VAC  | 10ms/115VAC at full load  |              |                                  |       |
| INPUT                 | VOLTAGE RANGE  | 90 ~ 264VAC   | 127 ~ 370VDC |                                  |       |
|                       | FREQUENCY RANGE  | 47 ~ 63Hz   |              |                                  |       |
|                       | EFFICIENCY (Typ.)  | 84%   |              | 86%                              |       |
|                       | AC CURRENT (Typ.)  | 0.75A/115VAC  | 0.5A/230VAC  |                                  |       |
|                       | INRUSH CURRENT (Typ.)  | COLD START 20A/115VAC   | 40A/230VAC   |                                  |       |
|                       | LEAKAGE CURRENT  | <1mA/ 240VAC  |              |                                  |       |
| PROTECTION            | OVERLOAD   | 105 ~ 150% rated output power<br>Protection type : Hiccup mode, recovers automatically after fault condition is removed |              |                                  |       |
|                       | OVER VOLTAGE   | CH1:14.49 ~ 19.5V   |              | CH1:28.98 ~ 39.5V                |       |
|                       | BATTERY CUT OFF  | 10 ± 0.5V   |              | 20 ± 1V                          |       |
| FUNCTION              | AC OK  | TTL open collector output, ON : AC OK ; OFF : AC Fail ; Ice : max. 30mA@ 50VDC  |              |                                  |       |
|                       | BATTERY LOW  | TTL open collector output, ON : Battery Low ; OFF : Battery OK ; Ice : max. 30mA@ 50VDC                                 |              | Battery low voltage : < 22V      |       |
| ENVIRONMENT           | WORKING TEMP.  | -30 ~ +70°C (Refer to "Derating Curve")   |              |                                  |       |
|                       | WORKING HUMIDITY   | 20 ~ 90% RH non-condensing  |              |                                  |       |
|                       | STORAGE TEMP., HUMIDITY  | -20 ~ +85°C, 10 ~ 95% RH  |              |                                  |       |
|                       | TEMP. COEFFICIENT  | ± 0.03%/°C (0~50°C) on CH1 output   |              |                                  |       |
|                       | VIBRATION  | 10 ~ 500Hz, 2G 10min./1cycle, 60min. each along X, Y, Z axes  |              |                                  |       |
| SAFETY & EMC (Note 4) | SAFETY STANDARDS   | UL62368-1, TUV EN62368-1, EAC TP TC 004 approved  |              |                                  |       |
|                       | WITHSTAND VOLTAGE  | I/P-O/P:3KVAC I/P-FG:2KVAC O/P-FG:0.5KVAC   |              |                                  |       |
|                       | ISOLATION RESISTANCE   | I/P-O/P, I/P-FG, O/P-FG:100M Ohms / 500VDC / 25°C / 70% RH  |              |                                  |       |
|                       | EMC EMISSION   | Compliance to EN55032 (CISPR32) Class B, EN61000-3-2,-3, EAC TP TC 020  |              |                                  |       |
|                       | EMC IMMUNITY   | Compliance to EN61000-4-2,3,4,5,6,8,11, EN55024, light industry level, criteria A, EAC TP TC 020                        |              |                                  |       |
| OTHERS                | MTBF   | 658.4 K hrs min. MIL-HDBK-217F (25°C)   |              |                                  |       |
|                       | DIMENSION  | PCB:84.6*50.8*24mm (L*W*H) ; Enclosed type:86.4*59.6*30mm (L*W*H)   |              |                                  |       |
|                       | PACKING  | PCB:0.092Kg;90pcs/9.28Kg/0.97CUFT ; Enclosed type: 0.145Kg;100pcs/15.5Kg/1.03CUFT                                       |              |                                  |       |
| NOTE                  | <p>1. All parameters NOT specially mentioned are measured at 230VAC input, rated load and 25°C of ambient temperature.</p> <p>2. Ripple &amp; noise are measured at 20MHz of bandwidth by using a 12" twisted pair-wire terminated with a 0.1uf &amp; 47uf parallel capacitor.</p> <p>3. Tolerance : includes set up tolerance, line regulation and load regulation.</p> <p>4. Length of set up time is measured at first cold start. Turning ON/OFF the power supply may lead to increase of the set up time.</p> <p>5. Heat sink HS1,HS2 can not be shorted.</p> <p>6. Heat sink HS1 must have safety isolation distance with system case.</p> <p>7. The power supply is considered a component which will be installed into a final equipment. The final equipment must be re-confirmed that it still meets EMC directives. For guidance on how to perform these EMC tests, please refer to "EMI testing of component power supplies." (as available on <a href="http://www.meanwell.com">http://www.meanwell.com</a>)</p> <p>8. The ambient temperature derating of 3.5°C/1000m with fanless models and of 5°C/1000m with fan models for operating altitude higher than 2000m(6500ft).</p> <p>※ Product Liability Disclaimer : For detailed information, please refer to <a href="https://www.meanwell.com/serviceDisclaimer.aspx">https://www.meanwell.com/serviceDisclaimer.aspx</a></p> |   |              |                                  |       |

■ Block Diagram

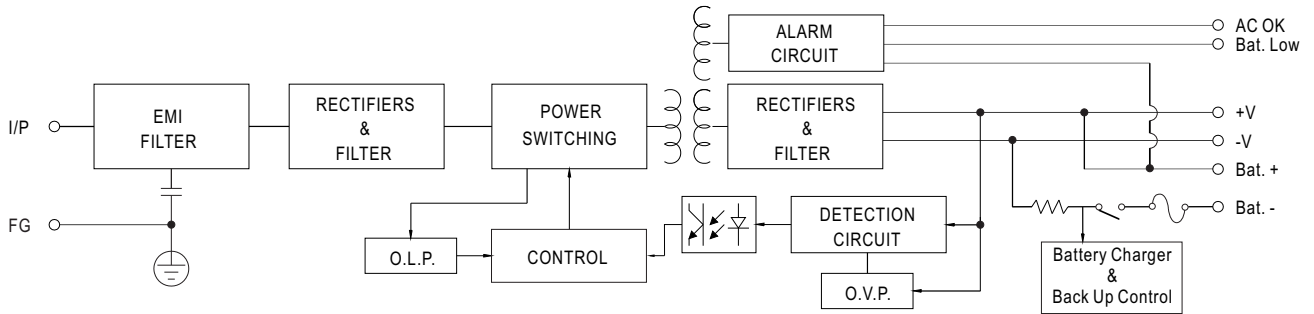

■ Output Derating

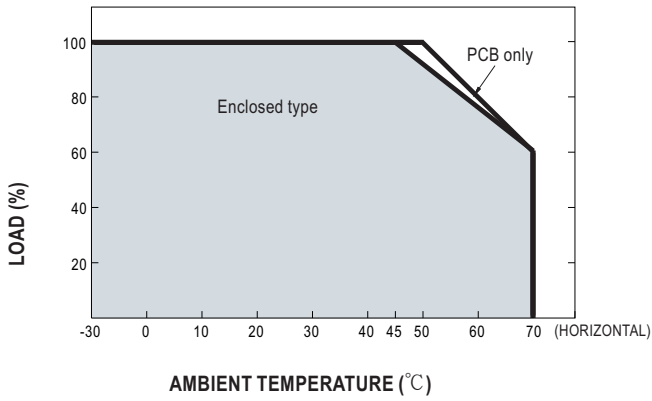

■ Output Derating VS Input Voltage

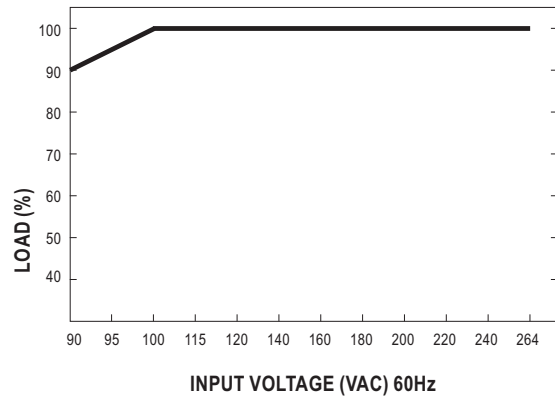

■ Suggested Application

1. Backup connection for AC interruption

(1) Please refer to the Fig1.1 for suggested connection.

The power supply charges the battery and provides energy to the load at the same time when the AC main is OK.  
The battery starts to supply power to the load when the AC mains fails.

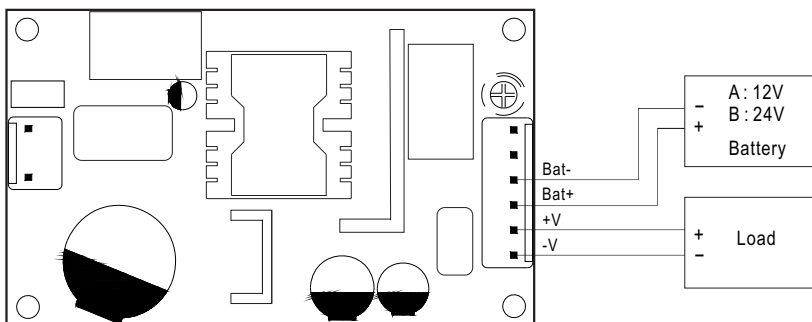

Fig 1.1 Suggested system connection

**2. Alarm Signal for AC OK and Battery Low**

- (1) Alarm Signal is sent out through "AC OK" & "Battery Low" pins.
- (2) An external voltage source is required for this function. The maximum applied voltage is 50V and the maximum sink current is 30mA.
- (3) Table 2.1 explains the alarm function built in the power supply

| Function    | Description  | Output of alarm                                 |
|-------------|--|---|
| AC OK       | The signal is "Low" when the power supply turns on                     | Low (0.3V max. at 30mA)                         |
|             | The signal turns to be "High" when the power supply turns OFF          | High or open(External applied voltage 50V max.) |
| Battery Low | The signal is "Low" when the voltage of battery is under A:11V, B:22V  | Low (0.3V max. at 30mA)                         |
|             | The signal is "High" when the voltage of battery is above A:11V, B:22V | High or open(External applied voltage 50V max.) |

Table 2.1 Explanation of Alarm Signal

AC OK (Battery low)

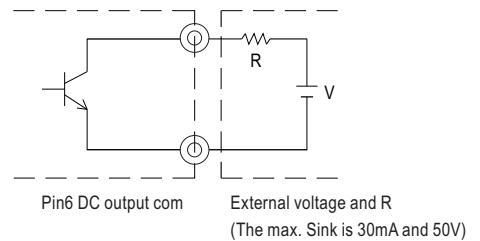
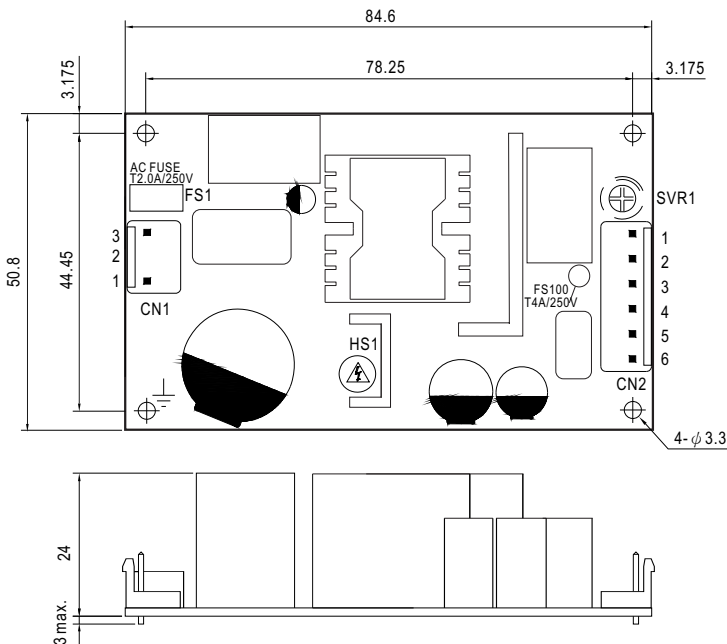

Fig 2.2 Internal circuit of AC OK (Battery Low)

**Mechanical Specification**

Unit:mm



- 1. HS1, HS2 can not be shorted.
- 2. HS1 must have safety isolation distance with system case.
- 3. ⚡ Gronding required
- 4. -V and Bat- can not be shorted

AC Input Connector (CN1) : JST B3P-VH or equivalent

| Pin No. | Assignment | Mating Housing        | Terminal                       |
|---------|------------|-----------------------|--------------------------------|
| 1       | AC/N       | JST VHR or equivalent | JST SVH-21T-P1.1 or equivalent |
| 2       | No Pin     |                       |                                |
| 3       | AC/L       |                       |                                |

DC Output Connector (CN2) : JST B6P-VH or equivalent

| Pin No. | Assignment | Pin No. | Assignment | Mating Housing        | Terminal                       |
|---------|------------|---------|------------|-----------------------|--------------------------------|
| 1       | Bat. Low   | 4       | Battery +  | JST VHR or equivalent | JST SVH-21T-P1.1 or equivalent |
| 2       | AC OK      | 5       | +V         |                       |                                |
| 3       | Battery -  | 6       | -V         |                       |                                |

**Installation Manual**

Please refer to : <http://www.meanwell.com/manual.html>

