

Single IGBTMOD™ A-Series Module 400 Amperes/1200 Volts

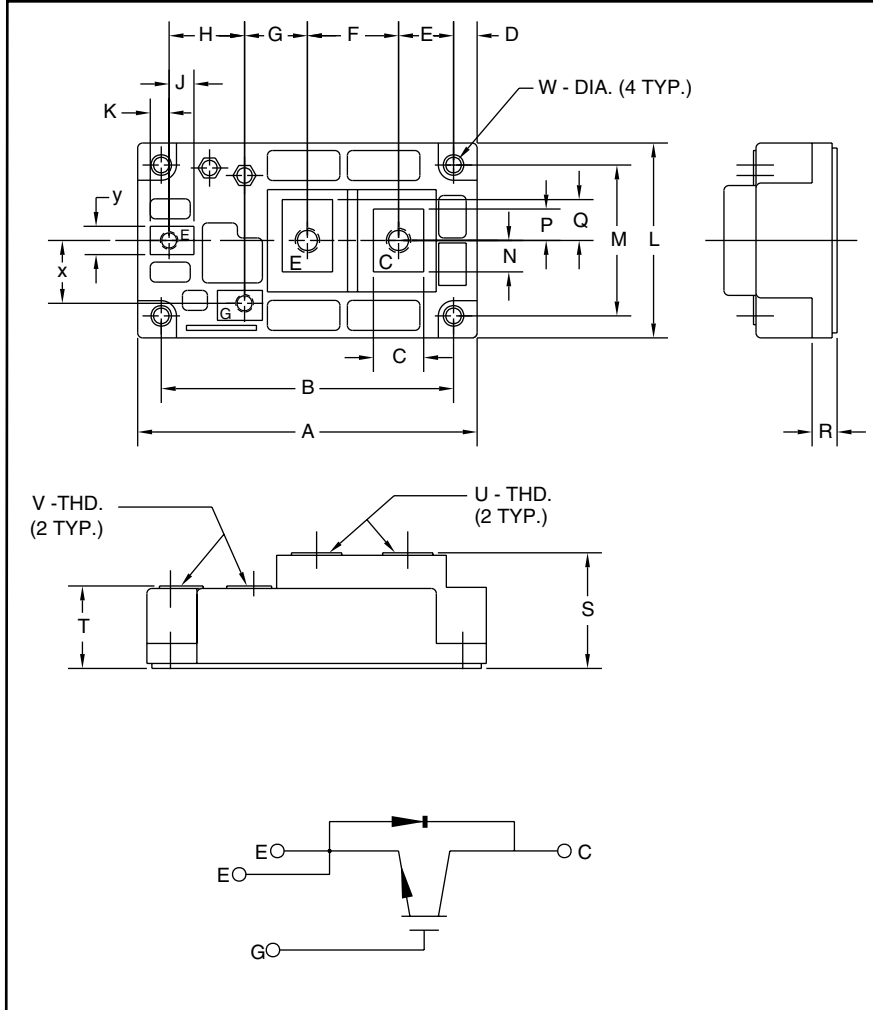

Outline Drawing and Circuit Diagram

Dimensions	Inches	Millimeters
A	4.25	108.0
B	3.66	93.0
C	0.63	16.0
D	0.30	7.5
E	0.69	17.5
F	1.14	29.0
G	0.79	20.0
H	0.94	24.0
J	0.31	7.9
K	0.24	6.0
L	2.44	62.0
M	1.89	48.0

Dimensions	Inches	Millimeters
N	0.39	10.0
P	0.39	10.0
Q	0.51	13.0
R	0.33	8.5
S	1.42	36.0
T	1.02	25.8
U	M6 Metric	M6
V	M4 Metric	M4
W	0.256	6.5
X	0.79	20.0
Y	0.35	9.0



Description:

Powerex IGBTMOD™ Modules are designed for use in switching applications. Each module consists of one IGBT Transistor in a single configuration with a reverse connected super-fast recovery free-wheel diode. All components and interconnects are isolated from the heat sinking baseplate, offering simplified system assembly and thermal management.

Features:

- Low Drive Power
- Low $V_{CE(sat)}$
- Discrete Super-Fast Recovery Free-Wheel Diode
- Isolated Baseplate for Easy Heat Sinking

Applications:

- DC Chopper
- Inverter
- UPS
- Forklift

Ordering Information:

Example: Select the complete part module number you desire from the table below - i.e. CM400HA-24A is a 1200V (V_{CES}), 400 Ampere Single IGBTMOD™ Power Module.

Type	Current Rating Amperes	V_{CES} Volts (x 50)
CM	400	24



Powerex, Inc., 200 E. Hillis Street, Youngwood, Pennsylvania 15697-1800 (724) 925-7272

CM400HA-24A
Single IGBTMOD™ A-Series Module
 400 Amperes/1200 Volts

Absolute Maximum Ratings, $T_j = 25^\circ\text{C}$ unless otherwise specified

Ratings	Symbol	CM400HA-24A	Units
Junction Temperature	T_j	-40 to 150	$^\circ\text{C}$
Storage Temperature	T_{stg}	-40 to 125	$^\circ\text{C}$
Collector-Emitter Voltage (G-E Short)	V_{CES}	1200	Volts
Gate-Emitter Voltage (C-E Short)	V_{GES}	± 20	Volts
Collector Current (DC, $T_C = 87^\circ\text{C}^*$)	I_C	400	Amperes
Peak Collector Current	I_{CM}	800**	Amperes
Emitter Current*** ($T_C = 25^\circ\text{C}$)	I_E	400	Amperes
Peak Emitter Current***	I_{EM}	800**	Amperes
Maximum Collector Dissipation ($T_C = 25^\circ\text{C}^*$, $T_j \leq 150^\circ\text{C}$)	P_C	2350	Watts
Mounting Torque, M6 Main Terminal	—	40	in-lb
Mounting Torque, M6 Mounting	—	40	in-lb
Mounting Torque, M4 G(E) Terminal	—	15	in-lb
Weight	—	480	Grams
Isolation Voltage (Main Terminal to Baseplate, AC 1 min.)	V_{ISO}	2500	Volts

Static Electrical Characteristics, $T_j = 25^\circ\text{C}$ unless otherwise specified

Characteristics	Symbol	Test Conditions	Min.	Typ.	Max.	Units
Collector-Cutoff Current	I_{CES}	$V_{\text{CE}} = V_{\text{CES}}, V_{\text{GE}} = 0\text{V}$	—	—	1.0	mA
Gate Leakage Current	I_{GES}	$V_{\text{GE}} = V_{\text{GES}}, V_{\text{CE}} = 0\text{V}$	—	—	0.5	μA
Gate-Emitter Threshold Voltage	$V_{\text{GE(th)}}$	$I_C = 40\text{mA}, V_{\text{CE}} = 10\text{V}$	6.0	7.0	8.0	Volts
Collector-Emitter Saturation Voltage	$V_{\text{CE(sat)}}$	$I_C = 400\text{A}, V_{\text{GE}} = 15\text{V}, T_j = 25^\circ\text{C}$	—	2.1	3.0	Volts
		$I_C = 400\text{A}, V_{\text{GE}} = 15\text{V}, T_j = 125^\circ\text{C}$	—	2.4	—	Volts
Total Gate Charge	Q_G	$V_{\text{CC}} = 600\text{V}, I_C = 400\text{A}, V_{\text{GE}} = 15\text{V}$	—	2000	—	nC
Emitter-Collector Voltage**	V_{EC}	$I_E = 400\text{A}, V_{\text{GE}} = 0\text{V}$	—	—	3.8	Volts

Dynamic Electrical Characteristics, $T_j = 25^\circ\text{C}$ unless otherwise specified

Characteristics	Symbol	Test Conditions	Min.	Typ.	Max.	Units
Input Capacitance	C_{ies}		—	—	70	nf
Output Capacitance	C_{oes}	$V_{\text{CE}} = 10\text{V}, V_{\text{GE}} = 0\text{V}$	—	—	6	nf
Reverse Transfer Capacitance	C_{res}		—	—	1.4	nf
Inductive Load	Turn-on Delay Time	$V_{\text{CC}} = 600\text{V}, I_C = 400\text{A},$ $V_{\text{GE}1} = V_{\text{GE}2} = 15\text{V}, R_G = 0.78\Omega,$	—	—	550	ns
	Rise Time					
Switch Time	Turn-off Delay Time	Inductive Load	—	—	600	ns
	Fall Time					
Diode Reverse Recovery Time***	t_{rr}	Switching Operation,	—	—	250	ns
Diode Reverse Recovery Charge***	Q_{rr}	$I_E = 400\text{A}$	—	14.7	—	μC

* T_C, T_f measured point is just under the chips.

**Pulse width and repetition rate should be such that device junction temperature (T_j) does not exceed $T_{j(\text{max})}$ rating.

***Represents characteristics of the anti-parallel, emitter-to-collector free-wheel diode (FWDI).

CM400HA-24A
Single IGBTMOD™ A-Series Module
 400 Amperes/1200 Volts

Thermal and Mechanical Characteristics, $T_j = 25^\circ\text{C}$ unless otherwise specified

Characteristics	Symbol	Test Conditions	Min.	Typ.	Max.	Units
Thermal Resistance, Junction to Case*	$R_{th(j-c)Q}$	Per IGBT	—	—	0.053	$^\circ\text{C/W}$
Thermal Resistance, Junction to Case*	$R_{th(j-c)D}$	Per FWDi	—	—	0.085	$^\circ\text{C/W}$
Contact Thermal Resistance	$R_{th(c-f)}$	Thermal Grease Applied	—	0.02	—	$^\circ\text{C/W}$
External Gate Resistance	R_G		0.78	—	10	Ω

* T_C , T_f measured point is just under the chips.

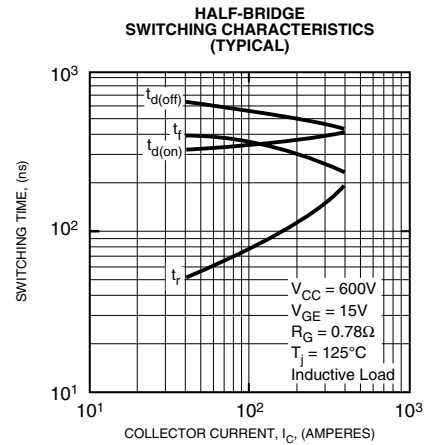
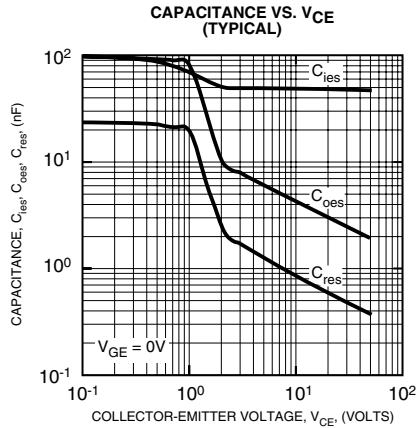
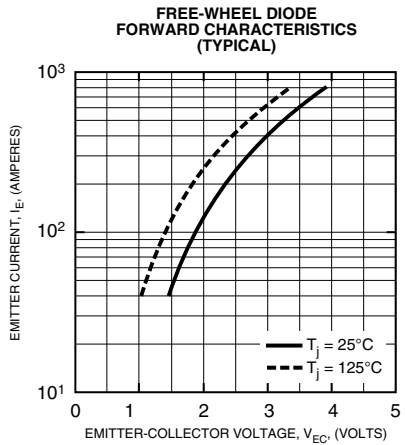
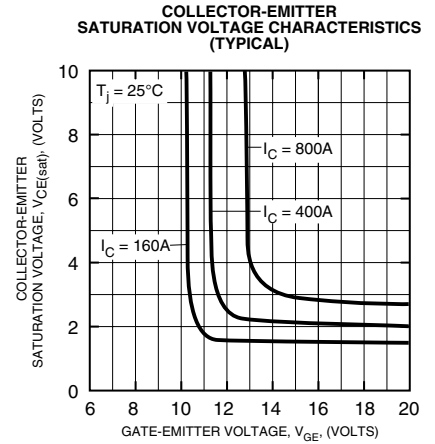
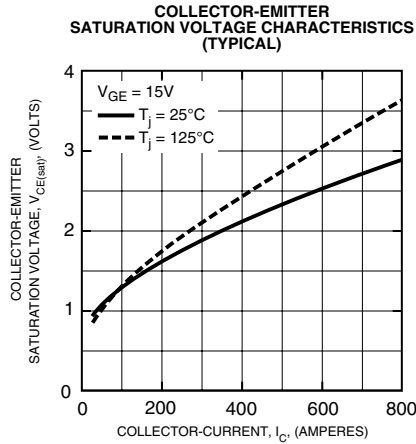
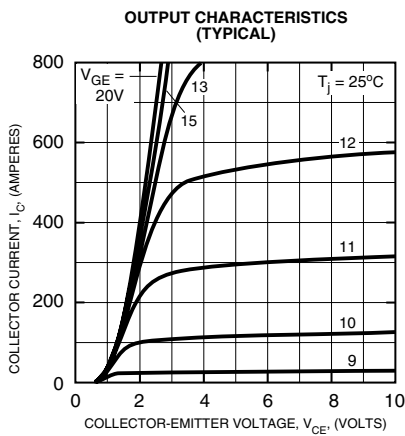

CM400HA-24A
Single IGBTMOD™ A-Series Module
 400 Amperes/1200 Volts

REVERSE RECOVERY CHARACTERISTICS (TYPICAL)

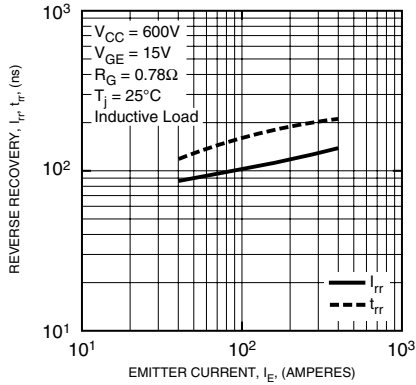

GATE CHARGE VS. V_{GE}

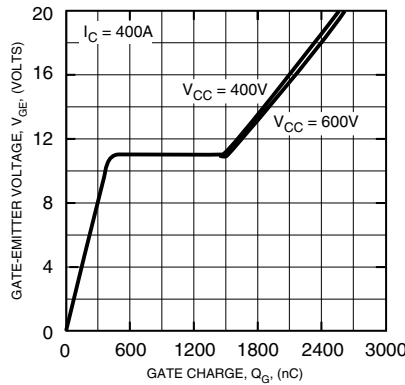

SWITCHING LOSS VS. COLLECTOR CURRENT (TYPICAL)

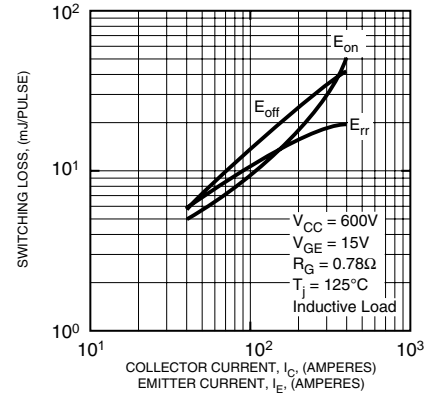

SWITCHING LOSS VS. GATE RESISTANCE (TYPICAL)

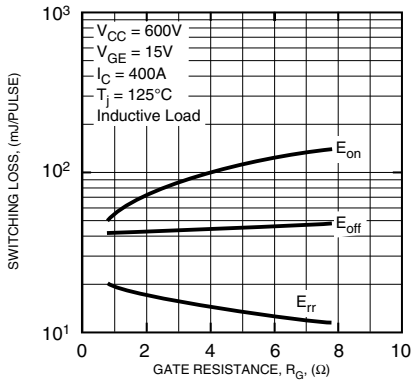

TRANSIENT THERMAL IMPEDANCE CHARACTERISTICS (IGBT & FWDI)

