

M57719L

135-145MHz, 12.5V, 14W, FM MOBILE RADIO

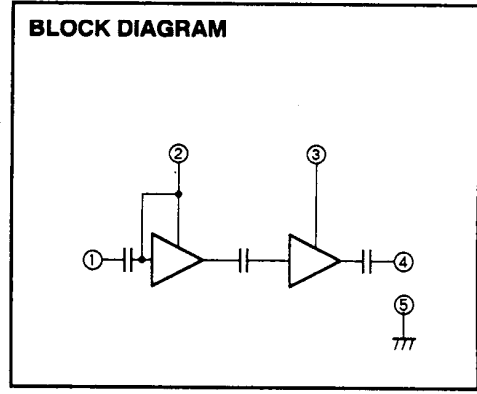
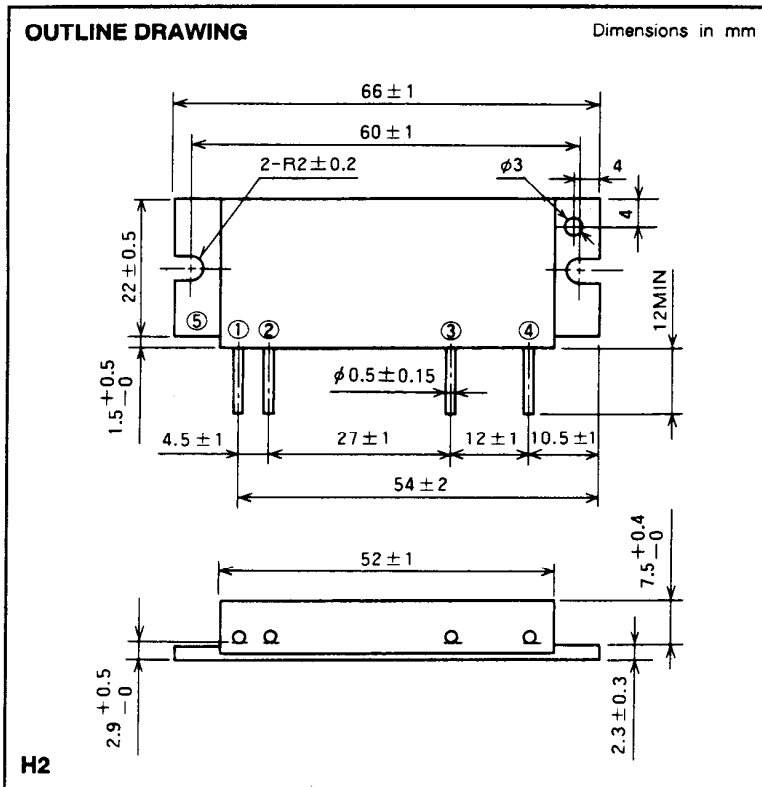

PIN :
 ①Pin : RF INPUT
 ②Vcc1 : 1st. DC SUPPLY
 ③Vcc2 : 2nd. DC SUPPLY
 ④Po : RF OUTPUT
 ⑤GND : FIN

ABSOLUTE MAXIMUM RATINGS (T_c = 25 °C unless otherwise noted)

Symbol	Parameter	Conditions	Ratings	Unit
V _{cc}	Supply voltage		17	V
I _{cc}	Total current		6	A
P _{in(max)}	Input power	Z _G = Z _L = 50 Ω	0.4	W
P _{o(max)}	Output power	Z _G = Z _L = 50 Ω	20	W
T _{c(OP)}	Operation case temperature		- 30 to 110	°C
T _{stg}	Storage temperature		- 40 to 110	°C

Note. Above parameters are guaranteed independently.

ELECTRICAL CHARACTERISTICS (T_c = 25 °C unless otherwise noted)

Symbol	Parameter	Test conditions	Limits		Unit
			Min	Max	
f	Frequency range	P _{in} = 0.2W V _{cc} = 12.5V Z _G = Z _L = 50 Ω	135	145	MHz
P _o	Output power		14		W
η _T	Total efficiency		40		%
2f _o	2nd. harmonic			- 25	dBc
3f _o	3rd. harmonic			- 35	dBc
ρ _{in}	Input VSWR			4	-
-	Load VSWR tolerance	V _{cc} = 15.2V, P _o = 14W (P _{in} : controlled) Load VSWR=20:1 (All phase), 2sec. Z _G = 50Ω	No degradation or destroy		-

Note. Above parameters, ratings, limits and conditions are subject to change.



TYPICAL PERFORMANCE DATA

OUTPUT POWER, TOTAL EFFICIENCY, INPUT VSWR VS. FREQUENCY

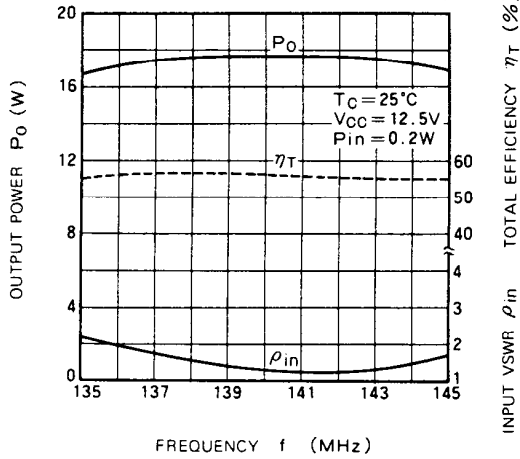

OUTPUT POWER, TOTAL EFFICIENCY, VS. INPUT POWER

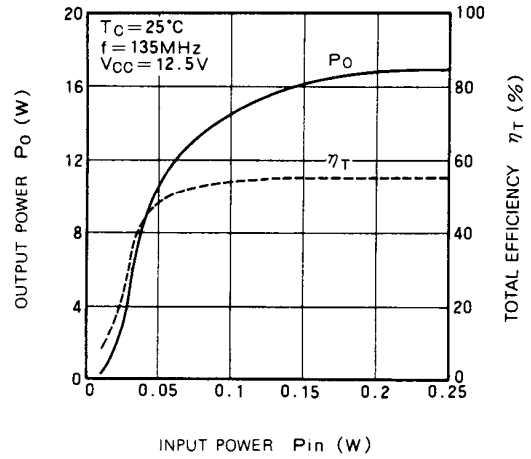

OUTPUT POWER, TOTAL EFFICIENCY, VS. INPUT POWER

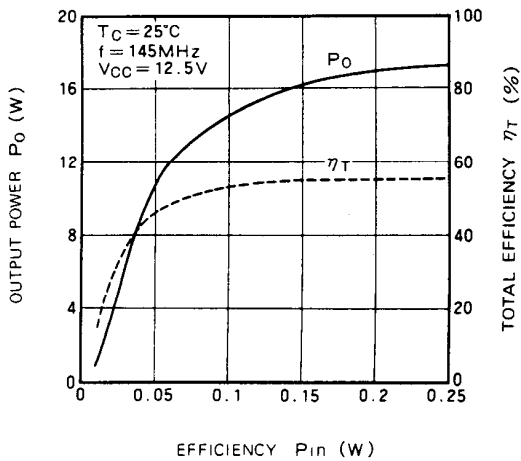

OUTPUT POWER VS. DC SUPPLY VOLTAGE

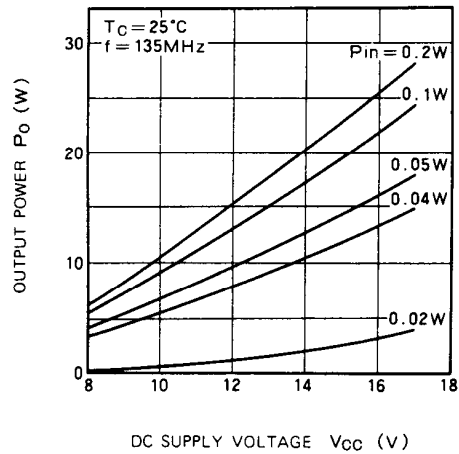

OUTPUT POWER VS. DC SUPPLY VOLTAGE

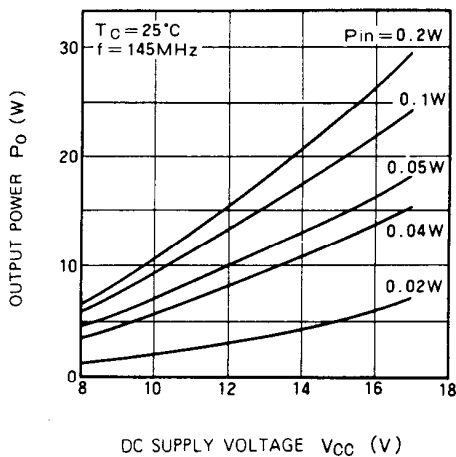

OUTPUT POWER VS. 1st VOLTAGE

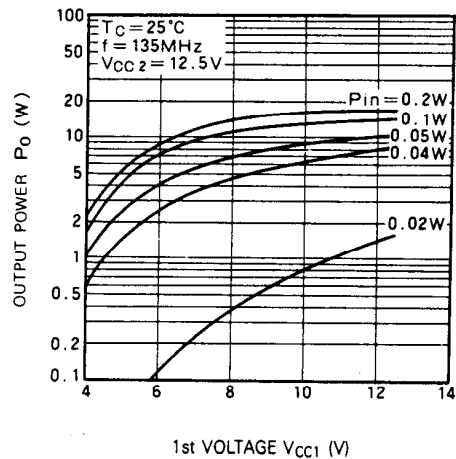

OUTPUT POWER VS. 1st VOLTAGE

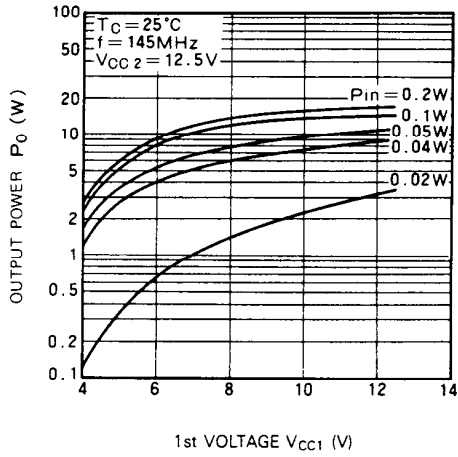

INPUT IMPEDANCE, OUTPUT IMPEDANCE VS. FREQUENCY

