

MITSUBISHI DIODE MODULES

RM250DZ/CZ/UZ-M,-H,-24,-2H

HIGH POWER GENERAL USE
INSULATED TYPE

RM250DZ/CZ/UZ-M,-H,-24,-2H



(DZ Type)

- **IF(AV)** Average forward current **250A**
- **VRRM** Repetitive peak reverse voltage
..... **400/800/1200/1600V**

- **DOUBLE ARMS**
- **Insulated Type**
- **UL Recognized**

Yellow Card No. E80276 (N)
File No. E80271

APPLICATION

AC motor controllers, DC motor controllers, Battery DC power supplies,
DC power supplies for control panels, and other general DC power equipment

OUTLINE DRAWING & CIRCUIT DIAGRAM

Dimensions in mm

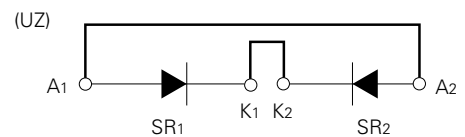
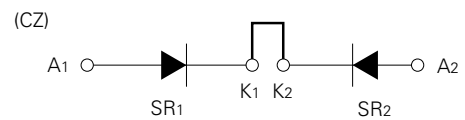
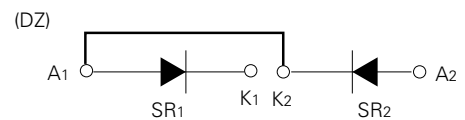
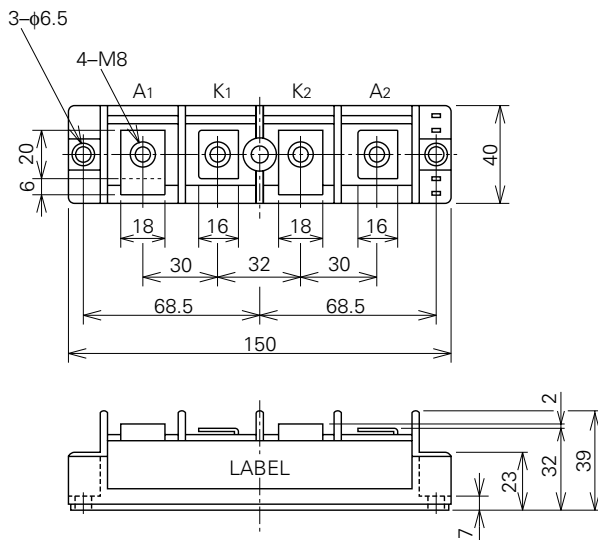

(Bold line is connective bar.)

RM250DZ/CZ/UZ-M,-H,-24,-2H

HIGH POWER GENERAL USE
INSULATED TYPE

ABSOLUTE MAXIMUM RATINGS

Symbol	Parameter	Voltage class				Unit
		M	H	24	2H	
VRRM	Repetitive peak reverse voltage	400	800	1200	1600	V
VRSM	Non-repetitive peak reverse voltage	480	960	1350	1700	V
VR (DC)	Reverse DC voltage	320	640	960	1280	V

Symbol	Parameter	Conditions	Ratings	Unit
IF (RMS)	RMS forward current		390	A
IF (AV)	Average forward current	Single-phase, half-wave 180° conduction, Tc=89°C	250	A
IFSM	Surge (non-repetitive) forward current	One half cycle at 60Hz, peak value	5000	A
I ² t	I ² t for fusing	Value for one cycle of surge current	1.0 × 10 ⁵	A ² s
f	Maximum operating frequency		1000	Hz
Tj	Junction temperature		-40~+150	°C
Tstg	Storage temperature		-40~+125	°C
Viso	Isolation voltage	Charged part to case	2500	V
—	Mounting torque	Main terminal screw M8	8.83~10.8	N·m
			90~110	kg·cm
		Mounting screw M6	1.96~3.92	N·m
—	Weight	Typical value	20~40	kg·cm
			300	g

ELECTRICAL CHARACTERISTICS

Symbol	Parameter	Test conditions	Limits			Unit
			Min.	Typ.	Max.	
IRRM	Repetitive reverse current	Tj=150°C, VRRM applied	—	—	30	mA
VFM	Forward voltage	Tj=25°C, IFM=750A, instantaneous meas.	—	—	1.3	V
Rth (j-c)	Thermal resistance	Junction to case (per 1/2 module)	—	—	0.2	°C/W
Rth (c-f)	Contact thermal resistance	Case to fin, conductive grease applied (per 1/2 module)	—	—	0.1	°C/W
—	Insulation resistance	Measured with a 500V megohmmeter between main terminal and case	10	—	—	MΩ

RM250DZ/CZ/UZ-M,-H,-24.-2H

HIGH POWER GENERAL USE
INSULATED TYPE

PERFORMANCE CURVE

MAXIMUM FORWARD CHARACTERISTIC

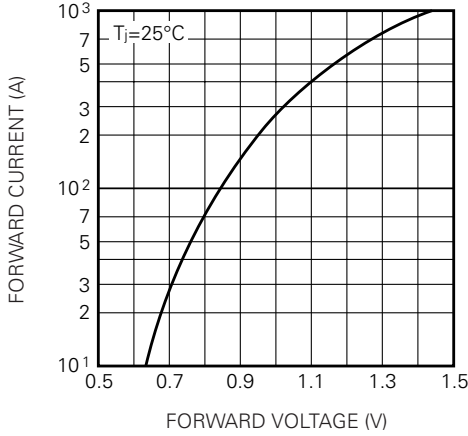

ALLOWABLE SURGE (NON-REPETITIVE) FORWARD CURRENT

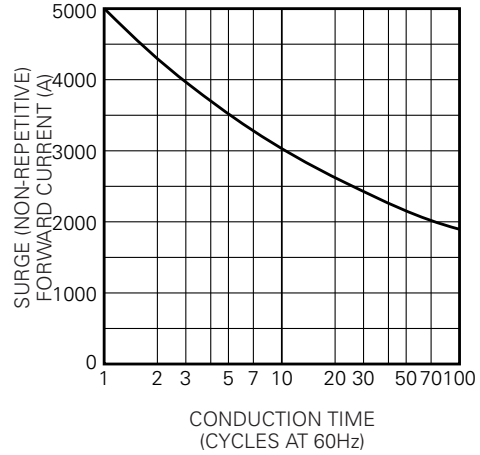

MAXIMUM TRANSIENT THERMAL IMPEDANCE (JUNCTION TO CASE)

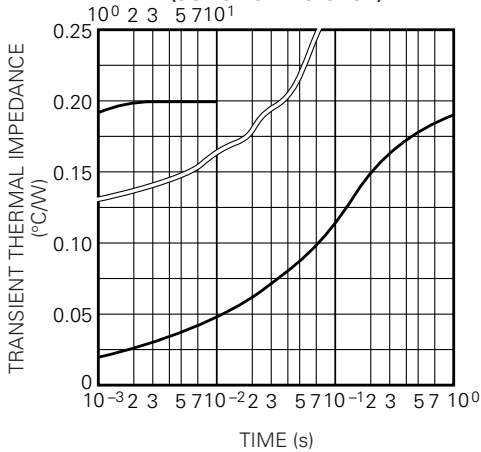

MAXIMUM POWER DISSIPATION

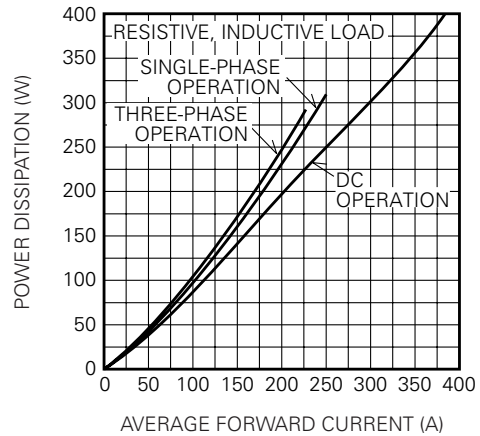

ALLOWABLE CASE TEMPERATURE VS. AVERAGE FORWARD CURRENT

