

MITSUBISHI THYRISTOR MODULES  
**TM90DZ/CZ-24,-2H**  
 HIGH VOLTAGE HIGH POWER GENERAL USE  
 INSULATED TYPE

TM90DZ/CZ-24,-2H



- **IT (AV)** Average on-state current ..... **90A**
- **VRRM** Repetitive peak reverse voltage  
 ..... **1200/1600V**
- **VDRM** Repetitive peak off-state voltage  
 ..... **1200/1600V**
- **DOUBLE ARMS**
- **Insulated Type**
- **UL Recognized**

Yellow Card No. E80276 (N)  
 File No. E80271

**APPLICATION**

DC motor control, NC equipment, AC motor control, Contactless switches,  
 Electric furnace temperature control, Light dimmers

**OUTLINE DRAWING & CIRCUIT DIAGRAM**

Dimensions in mm

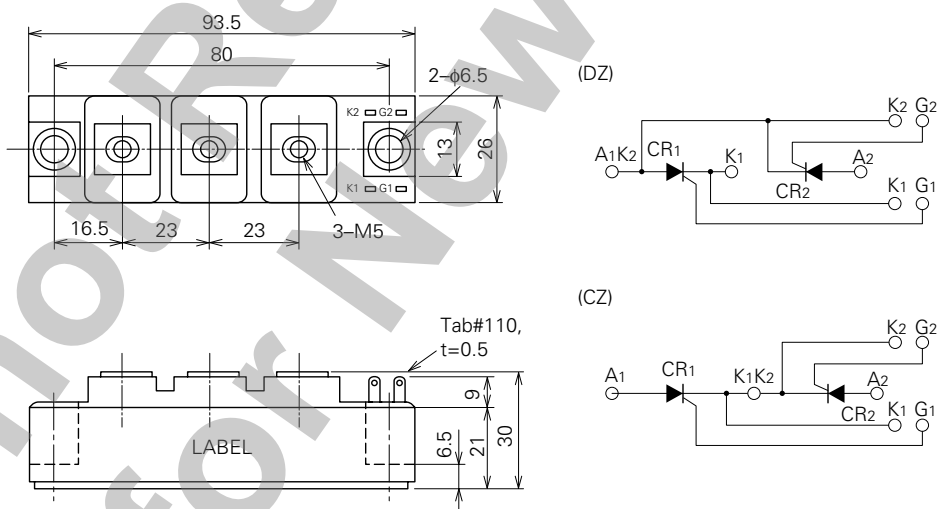

## TM90DZ/CZ-24,-2H

HIGH VOLTAGE HIGH POWER GENERAL USE  
INSULATED TYPE

## ABSOLUTE MAXIMUM RATINGS

Symbol	Parameter	Voltage class		Unit
		24	2H	
VRRM	Repetitive peak reverse voltage	1200	1600	V
VRSM	Non-repetitive peak reverse voltage	1350	1700	V
VR (DC)	DC reverse voltage	960	1280	V
VDRM	Repetitive peak off-state voltage	1200	1600	V
VDSM	Non-repetitive peak off-state voltage	1350	1700	V
VD (DC)	DC off-state voltage	960	1280	V

Symbol	Parameter	Conditions	Rated Values	Unit
IT (RMS)	RMS on-state current		140	A
IT (AV)	Average on-state current	Single-phase, half-wave 180° conduction, Tc=82°C	90	A
ITSM	Surge (non-repetitive) on-state current	One half cycle at 60Hz, peak value	1800	A
I <sup>2</sup> t	I <sup>2</sup> t for fusing	Value for one cycle of surge current	1.4 × 10 <sup>4</sup>	A <sup>2</sup> s
di/dt	Critical rate of rise of on-state current	V <sub>D</sub> =1/2V <sub>DRM</sub> , I <sub>G</sub> =1.0A, T <sub>j</sub> =125°C	100	A/μs
PGM	Peak gate power dissipation		5.0	W
PG (AV)	Average gate power dissipation		0.5	W
VFGM	Peak gate forward voltage		10	V
VRGM	Peak gate reverse voltage		5.0	V
IFGM	Peak gate forward current		2.0	A
T <sub>j</sub>	Junction temperature		-40~+125	°C
T <sub>stg</sub>	Storage temperature		-40~+125	°C
V <sub>iso</sub>	Isolation voltage	Charged part to case	2500	V
—	Mounting torque	Main terminal screw M5	1.47~1.96	N·m
			15~20	kg·cm
		Mounting screw M6	1.96~2.94	N·m
			20~30	kg·cm
—	Weight	Typical value	160	g

## ELECTRICAL CHARACTERISTICS

Symbol	Parameter	Test conditions	Limits			Unit
			Min.	Typ.	Max.	
I <sub>RRM</sub>	Repetitive peak reverse current	T <sub>j</sub> =125°C, V <sub>RRM</sub> applied	—	—	15	mA
I <sub>DRM</sub>	Repetitive peak off-state current	T <sub>j</sub> =125°C, V <sub>DRM</sub> applied	—	—	15	mA
V <sub>TM</sub>	On-state voltage	T <sub>j</sub> =125°C, I <sub>TM</sub> =270A, instantaneous meas.	—	—	1.4	V
dv/dt	Critical rate of rise of off-state voltage	T <sub>j</sub> =125°C, V <sub>D</sub> =2/3V <sub>DRM</sub>	500	—	—	V/μs
V <sub>GT</sub>	Gate trigger voltage	T <sub>j</sub> =25°C, V <sub>D</sub> =6V, R <sub>L</sub> =2Ω	—	—	2.0	V
V <sub>GD</sub>	Gate non-trigger voltage	T <sub>j</sub> =125°C, V <sub>D</sub> =1/2V <sub>DRM</sub>	0.25	—	—	V
I <sub>GT</sub>	Gate trigger current	T <sub>j</sub> =25°C, V <sub>D</sub> =6V, R <sub>L</sub> =2Ω	15	—	100	mA
R <sub>th (j-c)</sub>	Thermal resistance	Junction to case (per 1/2 module)	—	—	0.3	°C/W
R <sub>th (c-f)</sub>	Contact thermal resistance	Case to fin, conductive grease applied (per 1/2 module)	—	—	0.2	°C/W
—	Insulation resistance	Measured with a 500V megohmmeter between main terminal and case	10	—	—	MΩ

TM90DZ/CZ-24,-2H

HIGH VOLTAGE HIGH POWER GENERAL USE  
INSULATED TYPE

PERFORMANCE CURVES

MAXIMUM ON-STATE CHARACTERISTIC

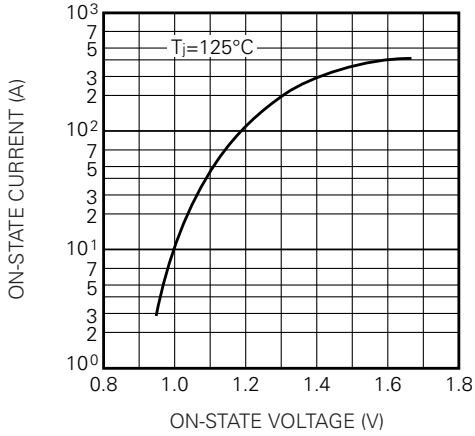

RATED SURGE (NON-REPETITIVE) ON-STATE CURRENT

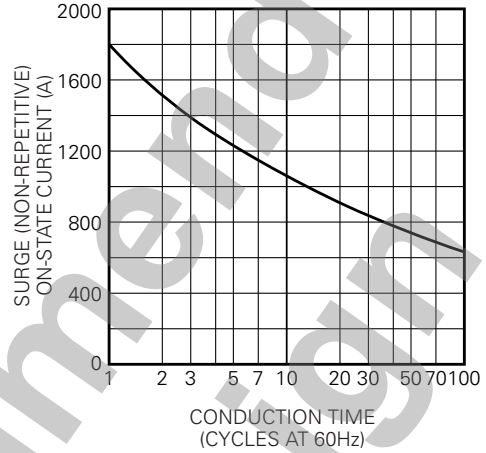

GATE CHARACTERISTICS

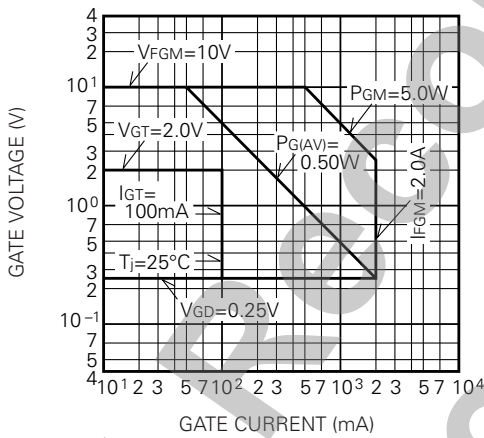

MAXIMUM TRANSIENT THERMAL IMPEDANCE (JUNCTION TO CASE)

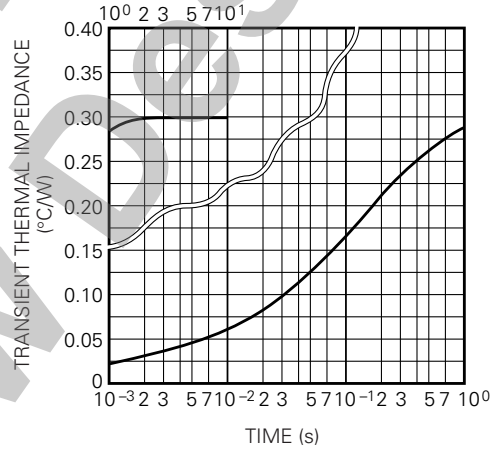

MAXIMUM AVERAGE ON-STATE POWER DISSIPATION (SINGLE PHASE HALF WAVE)

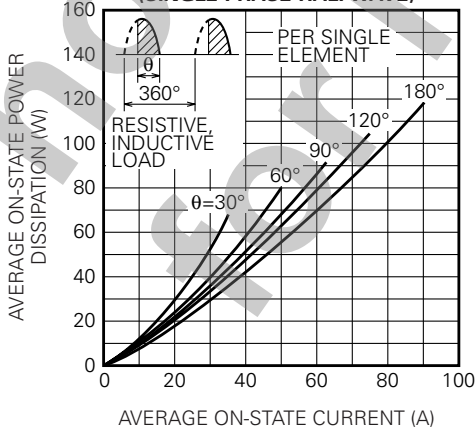

LIMITING VALUE OF THE AVERAGE ON-STATE CURRENT (SINGLE PHASE HALF WAVE)

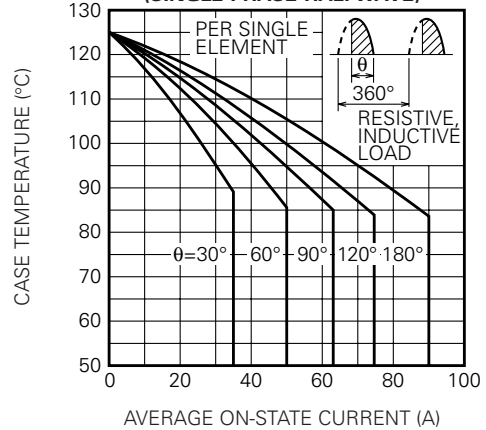

TM90DZ/CZ-24,-2H

HIGH VOLTAGE HIGH POWER GENERAL USE  
INSULATED TYPE

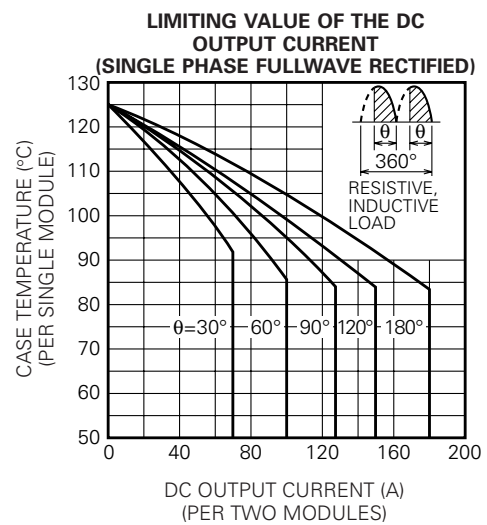
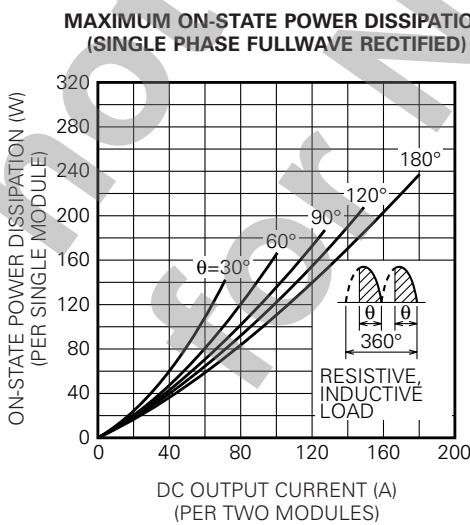
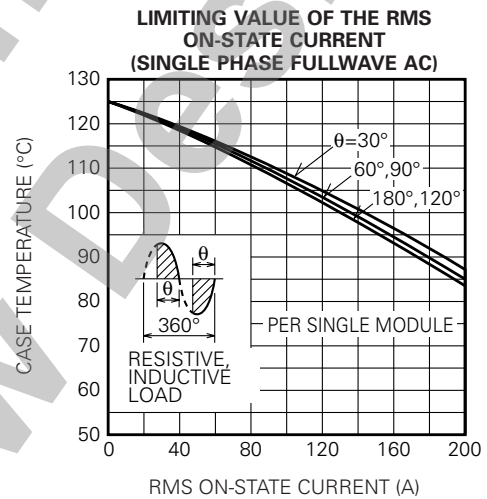
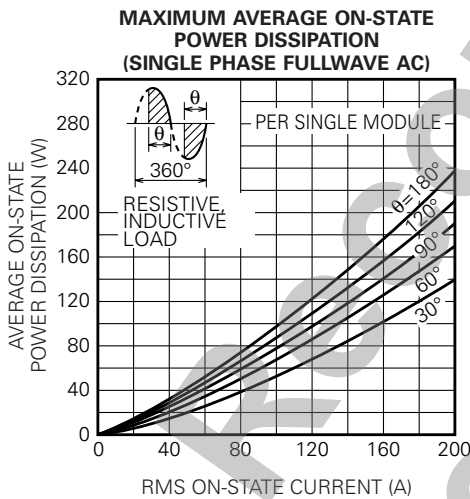
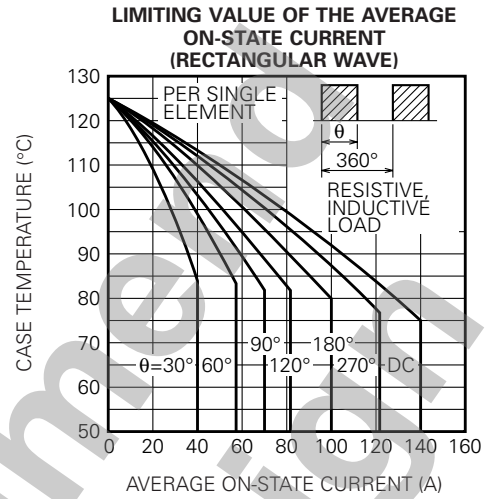
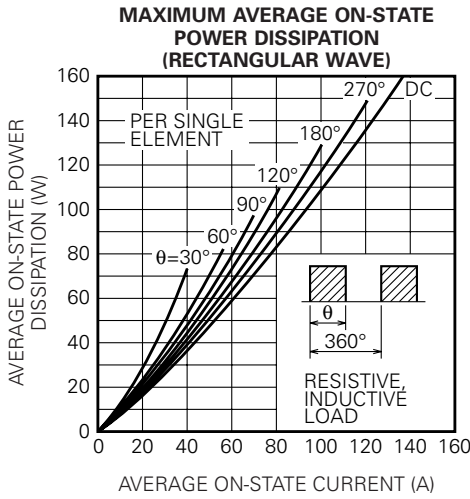

**TM90DZ/CZ-24,-2H**

HIGH VOLTAGE HIGH POWER GENERAL USE  
INSULATED TYPE

**MAXIMUM ON-STATE POWER DISSIPATION  
(THREE PHASE FULLWAVE RECTIFIED)**

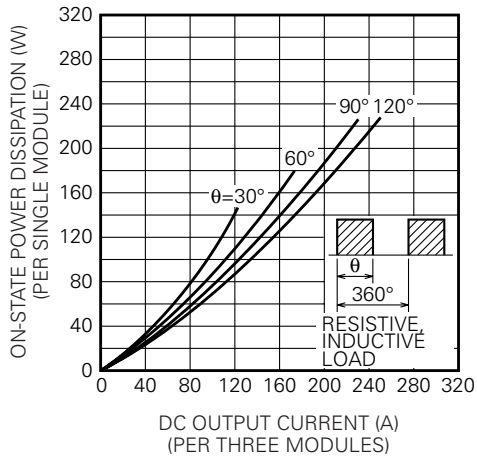

**LIMITING VALUE OF THE DC  
OUTPUT CURRENT  
(THREE PHASE FULLWAVE RECTIFIED)**

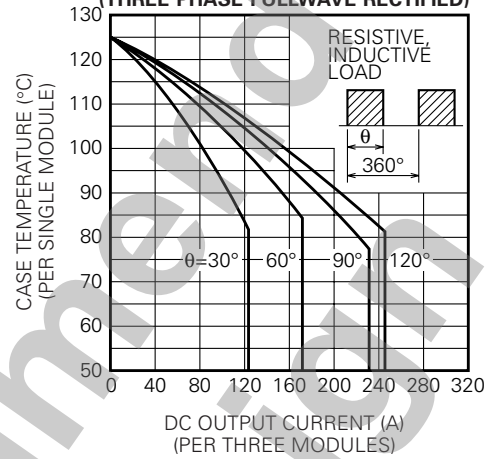

Not Recommended for New Design