

1W Isolated DC-DC converter  
Fixed input voltage, unregulated dual/single output

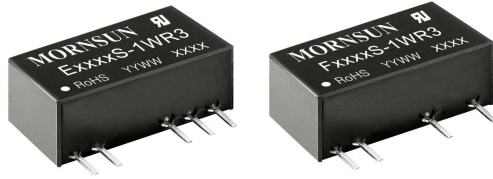

CB Report RoHS Patent Protection  
 UL 62368-1 EN 62368-1 BS EN 62368-1 IEC 62368-1

### FEATURES

- Continuous short-circuit protection
- No-load input current as low as 8mA
- Operating ambient temperature range: -40°C to +105°C
- High efficiency up to 81%
- I/O isolation test voltage: 3k VDC
- Industry standard pin-out

*E\_S-1WR3 & F\_S-1WR3 series are specially designed for applications where an isolated (two isolated) voltage is required in a distributed power supply system. They are suitable for: pure digital circuits, low frequency analog circuits, relay-driven circuits and data switching circuits.*

### Selection Guide

Certification	Part No.	Input Voltage (VDC)	Output		Full Load Efficiency (%) Min./Typ.	Capacitive Load(μF) Max.*	
		Nominal (Range)	Voltage (VDC)	Current (mA) Max./Min.			
UL/EN/BS EN/IEC	E1203S-1WR3	12 (10.8-13.2)	±3.3	±152/±15	71/75	1200	
	E1205S-1WR3		±5	±100/±10	76/80	1200	
--	E1209S-1WR3		±9	±56/±5	76/80	470	
UL/EN/BS EN/IEC	E1212S-1WR3		±12	±42/±5	77/81	220	
	E1215S-1WR3		±15	±34/±4	77/81	220	
	E1224S-1WR3		±24	±21/±2	76/80	100	
	F1203S-1WR3		3.3	303/30	71/75	2400	
	F1205S-1WR3		5	200/20	76/80	2400	
	F1209S-1WR3		9	111/12	76/80	1000	
	F1212S-1WR3		12	83/9	76/80	560	
	F1215S-1WR3		15	67/7	77/81	560	
--	F1224S-1WR3		24	42/5	77/81	220	
	E1505S-1WR3	15 (13.5-16.5)	±5	±100/±10	76/80	1200	
--	E1509S-1WR3		±9	±56/±5	76/80	470	
UL/EN/BS EN/IEC	E1512S-1WR3		±12	±42/±5	76/80	220	
	E1515S-1WR3		±15	±34/±4	77/81	220	
--	E1524S-1WR3		±24	±21/±2	77/81	100	
UL/EN/BS EN/IEC	F1505S-1WR3		5	200/20	76/80	2400	
	F1509S-1WR3		9	111/12	76/80	1000	
	F1512S-1WR3		12	83/9	76/80	560	
	F1515S-1WR3		15	67/7	77/81	560	
--	F1524S-1WR3		24	42/5	77/81	220	
--	E2403S-1WR3		24 (21.6-26.4)	±3.3	±150/±15	72/76	1200
UL/EN/BS EN/IEC	E2405S-1WR3			±5	±100/±10	74/80	1200
--	E2409S-1WR3	±9		±56/±5	74/80	470	
UL/EN/BS EN/IEC	E2412S-1WR3	±12		±42/±5	75/81	220	
	E2415S-1WR3	±15		±34/±4	73/79	220	
	E2424S-1WR3	±24		±21/±2	74/80	100	
UL/EN/BS EN/IEC	F2403S-1WR3	24 (21.6-26.4)	3.3	303/30	69/75	2400	
	F2405S-1WR3	5	200/20	73/79	2400		

--	F2407S-1WR3	24 (21.6-26.4)	7.2	139/13	74/80	1000
UL/EN/BS EN/IEC	F2409S-1WR3		9	111/12	74/80	1000
	F2412S-1WR3		12	83/9	75/81	560
UL/EN/BS EN/IEC	F2415S-1WR3		15	67/7	75/81	560
	F2424S-1WR3		24	42/5	75/81	220

Note: \*The specified maximum capacitive load for positive and negative output is identical.

### Input Specifications

Item	Operating Conditions	Min.	Typ.	Max.	Unit
Input Current (full load / no-load)	12V input	--	112/8	118/--	mA
	15V input	--	84/8	88/--	
	24V input	--	56/8	59/--	
Reflected Ripple Current*		--	15	--	
Surge Voltage(1sec. max.)	12VDC input	-0.7	--	18	VDC
	15VDC input	-0.7	--	21	
	24VDC input	-0.7	--	30	
Input Filter		Capacitance filter			
Hot Plug		Unavailable			

Note: \* Refer to DC-DC Converter Application Notes for detailed description of reflected ripple current test method.

### Output Specifications

Item	Operating Conditions	Min.	Typ.	Max.	Unit	
Voltage Accuracy		See output regulation curves (Fig. 1)				
Linear Regulation	Input voltage change: $\pm 1\%$	3.3VDC output	--	--	1.5	--
		Others	--	--	1.2	
Load Regulation	10%-100% load	3.3VDC output	--	15	20	%
		5VDC output	--	10	15	
		Others	--	8	10	
Ripple & Noise*	20MHz bandwidth	24VDC output	--	50	100	mVp-p
		Others	--	30	75	
Temperature Coefficient	Full load	--	$\pm 0.02$	--	%/°C	
Short-Circuit Protection		Continuous, self-recovery				

Note: \* The "parallel cable" method is used for Ripple and Noise test, please refer to DC-DC Converter Application Notes for specific information.

### General Specifications

Item	Operating Conditions	Min.	Typ.	Max.	Unit
Isolation	Input-output electric strength test for 1 minute with a leakage current of 1mA max.	3000	--	--	VDC
Insulation Resistance	Input-output resistance at 500VDC	1000	--	--	MΩ
Isolation Capacitance	Input-output capacitance at 100kHz/0.1V	--	20	--	pF
Operating Temperature	Derating when operating temperature $\geq 100^\circ\text{C}$ , (see Fig. 2)	-40	--	105	°C
Storage Temperature		-55	--	125	
Case Temperature Rise	Ta=25°C	--	25	--	
Pin Soldering Resistance Temperature	Soldering spot is 1.5mm away from case for 10 seconds	--	--	300	
Storage Humidity	Non-condensing	5	--	95	%RH
Vibration		10-150Hz, 5G, 0.75mm. along X, Y and Z			
Switching Frequency	Full load, nominal input voltage	--	260	--	kHz
MTBF	MIL-HDBK-217F@25°C	3500	--	--	k hours

Mechanical Specifications

Case Material	Black plastic; flame-retardant and heat-resistant (UL94V-0)
Dimensions	19.65 x 6.00 x 10.16mm
Weight	2.1g(Typ.)
Cooling Method	Free air convection

Electromagnetic Compatibility (EMC)

Emissions	CE	CISPR32/EN55032	CLASS B
	RE	CISPR32/EN55032	CLASS B
Immunity	ESD	IEC/EN61000-4-2	Air ±8kV, Contact ±6kV perf. Criteria B

Note: Refer to Fig. 4 for recommended circuit test.

Typical Performance Curves

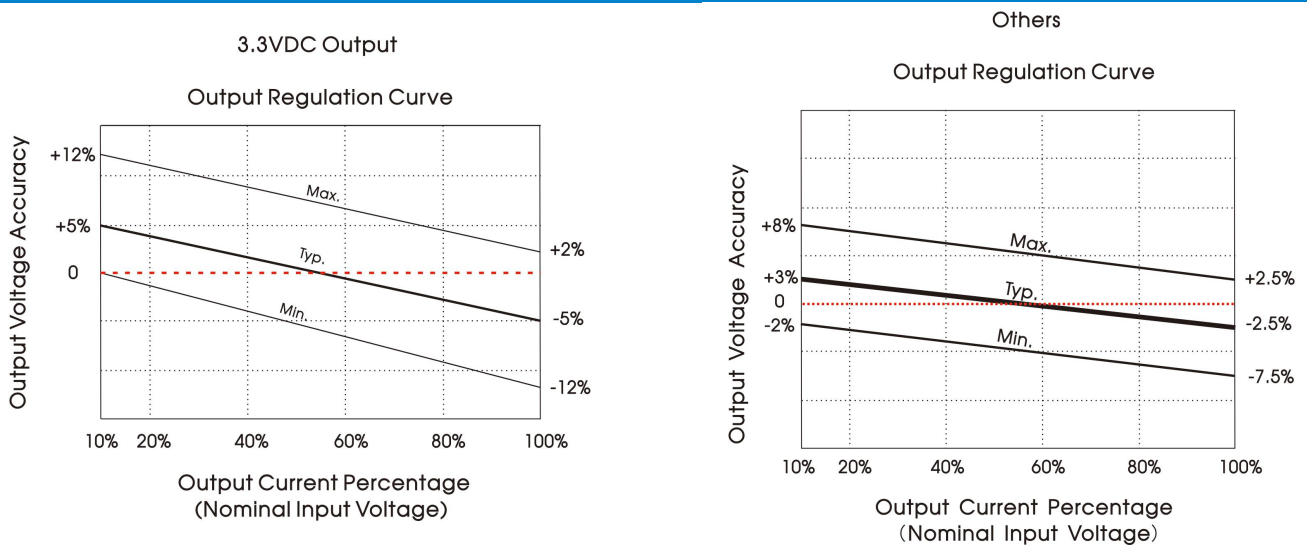

Fig. 1

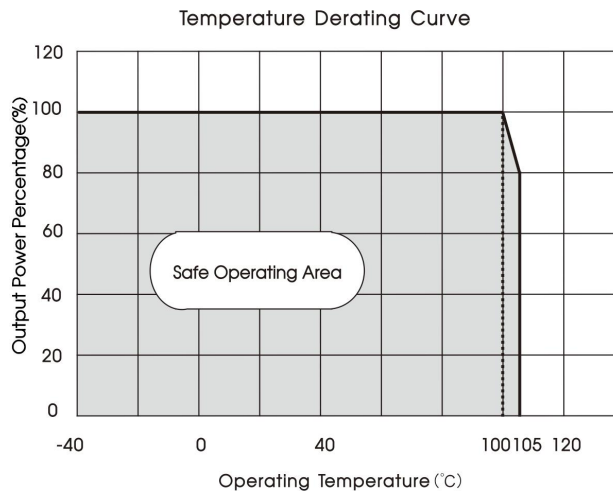
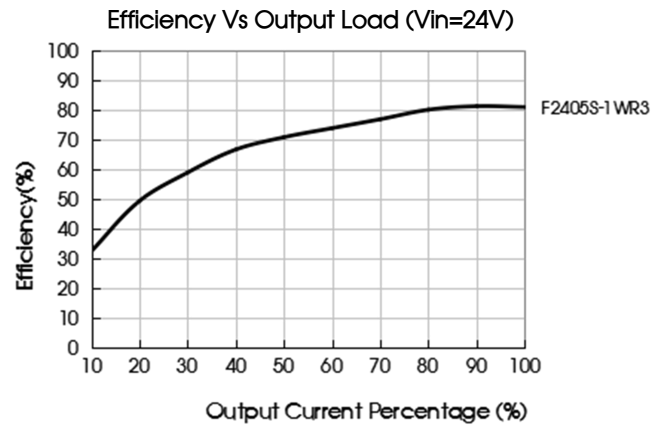
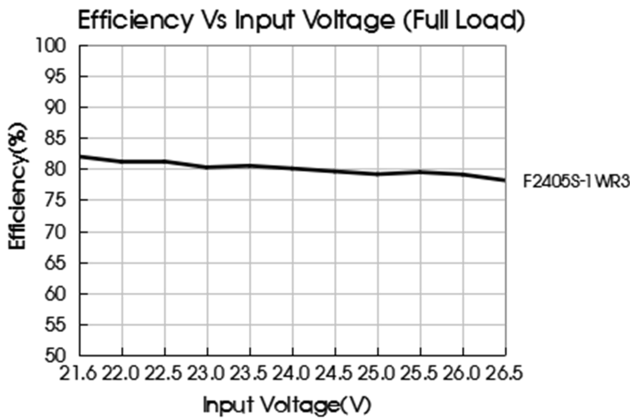
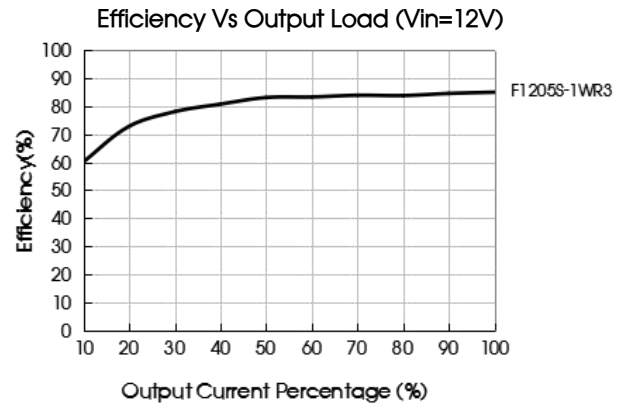
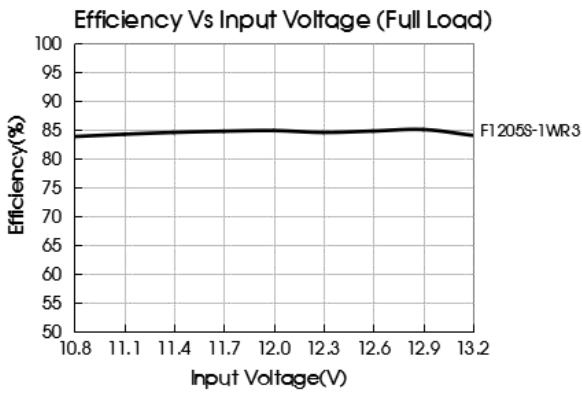

Fig. 2



## Design Reference

### 1. Typical application

Input and/or output ripple can be further reduced, by connecting a filter capacitor from the input and/or output terminals to ground as shown in Fig. 3.

Choosing suitable filter capacitor values is very important for a smooth operation of the modules, particularly to avoid start-up problems caused by capacitor values that are too high. For recommended input and output capacitor values refer to Table 1.

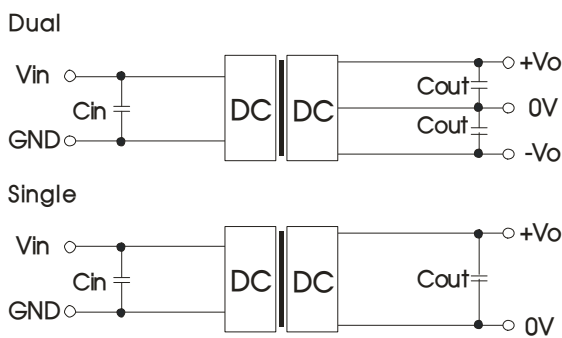

Fig. 3

Table 1: Recommended input and output capacitor values

Vin	Cin	Single output	Cout	Dual output	Cout
12VDC	2.2μF/25V	3.3VDC	10μF/16V	±3.3VDC	4.7μF/16V
15VDC	2.2μF/25V	5VDC	10μF/16V	±5VDC	4.7μF/16V
24VDC	1μF/50V	7.2VDC	2.2μF/16V	±9VDC	1μF/16V
--	--	9VDC	2.2μF/16V	±12VDC	1μF/25V
--	--	12VDC	2.2μF/25V	±15VDC	0.47μF/25V
--	--	15VDC	1μF/25V	±24VDC	0.47μF/50V
--	--	24VDC	1μF/50V	--	--

2. EMC compliance circuit

Dual

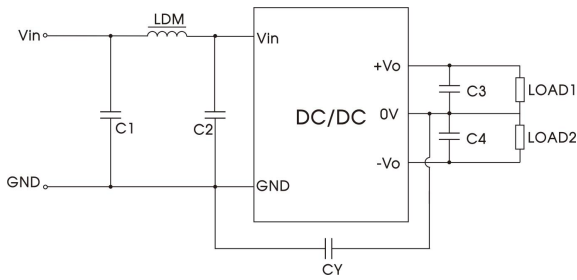

Single

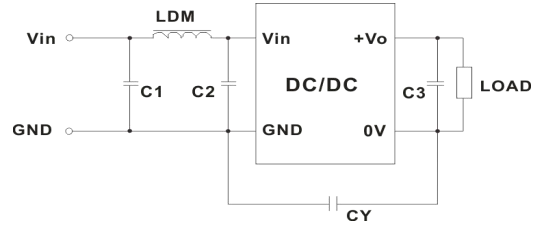

Fig. 4

Table 2: EMC recommended circuit value table

Emissions	C1/C2	4.7μF /50V
	CY	270pF /3kVDC
	C3/C4	Refer to the Cout in table 1
	LDM	6.8μH

3. For additional information please refer to DC-DC converter application notes on

[www.mornsun-power.com](http://www.mornsun-power.com)

Dimensions and Recommended Layout

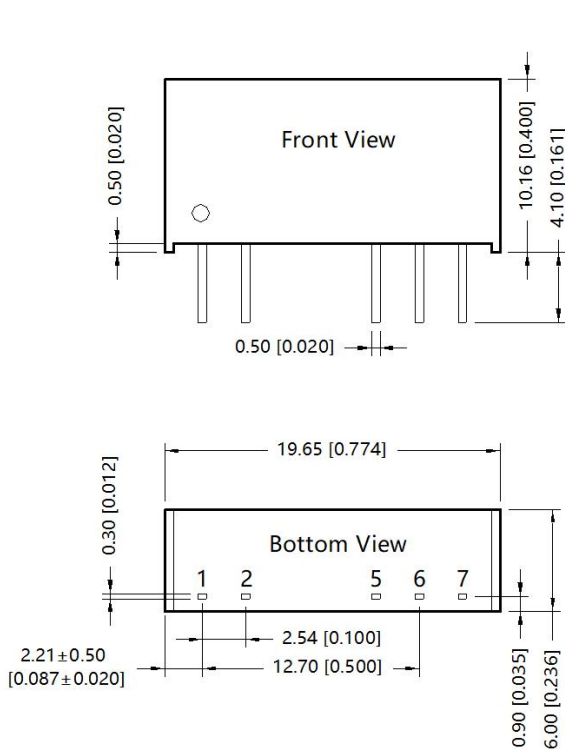

Note:

Unit: mm[inch]

Pin section tolerances: ±0.10[±0.004]

General tolerances: ±0.25[±0.010]

THIRD ANGLE PROJECTION

Dual Output

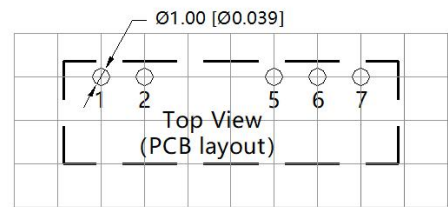

Single Output

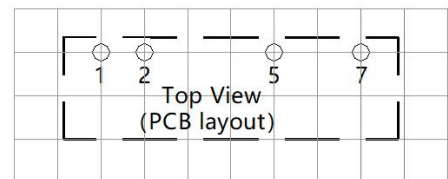

Note: Grid 2.54\*2.54mm

Pin	Single	Dual
1	Vin	Vin
2	GND	GND
5	0V	-Vo
6	No Pin	0V
7	+Vo	+Vo

Notes:

1. For additional information on Product Packaging please refer to [www.mornsun-power.com](http://www.mornsun-power.com). Tube Packaging bag number: 58200001;
2. If the product is not operated within the required load range, the product performance cannot be guaranteed to comply with all parameters in the datasheet;
3. The maximum capacitive load offered were tested at input voltage range and full load;
4. Unless otherwise specified, parameters in this datasheet were measured under the conditions of  $T_a=25^{\circ}\text{C}$ , humidity<75%RH with nominal input voltage and rated output load;
5. All index testing methods in this datasheet are based on our company corporate standards;
6. We can provide product customization service, please contact our technicians directly for specific information;
7. Products are related to laws and regulations: see "Features" and "EMC";
8. Our products shall be classified according to ISO14001 and related environmental laws and regulations, and shall be handled by qualified units.

MORNSUN Guangzhou Science & Technology Co., Ltd.

Address: No. 5, Kehui St. 1, Kehui Development Center, Science Ave., Guangzhou Science City, Huangpu District, Guangzhou, P. R. China  
Tel: 86-20-38601850 Fax: 86-20-38601272 E-mail: [info@mornsun.cn](mailto:info@mornsun.cn) [www.mornsun-power.com](http://www.mornsun-power.com)