

30W isolated DC-DC converter
Wide input and regulated single output



EN62368-1



BS EN62368-1

Patent Protection RoHS



FEATURES

- Wide 2:1 input voltage range
- High efficiency up to 90%
- No-load power consumption as low as 0.14W
- I/O isolation test voltage 1.5k VDC
- Output short-circuit, over-voltage, over-current protection
- Operating ambient temperature range: -40°C to +80°C
- Meets CISPR32/EN55032 CLASS A EMI without extra components
- Six-sided metal shielded package

VRB_LD-30WR3 series of isolated DC-DC converter products with a wide 2:1 input voltage and feature efficiencies of up to 90%, input to output isolation is tested with 1500VDC and the converters safely operate ambient temperature of -40°C to +80°C, output short-circuit, over-voltage, over-current protection. They meet CLASS A of CISPR32/EN55032 EMI standards without external components and they are widely used in applications such as data transmission device, battery power supply device, tele-communication device, distributed power supply system, hybrid module system, remote control system, industrial robot fields.

Selection Guide

Certification	Part No.	Input Voltage (VDC)		Output		Full Load Efficiency ^② (%) Min./Typ.	Max. Capacitive Load(μF)
		Nominal (Range)	Max. ^①	Voltage (VDC)	Current (mA) Max./Min.		
EN/BS EN	VRB2403LD-30WR3	24 (18-36)	40	3.3	6000/0	83/85	10000
	VRB2405LD-30WR3			5	6000/0	86/88	10000
	VRB2409LD-30WR3			9	3333/0	84/86	4700
	VRB2412LD-30WR3			12	2500/0	86/88	2700
	VRB2415LD-30WR3			15	2000/0	88/90	1680
	VRB2424LD-30WR3			24	1250/0	88/90	680
	VRB4803LD-30WR3	48 (36-75)	80	3.3	6000/0	84/86	10000
	VRB4805LD-30WR3			5	6000/0	86/88	10000
	VRB4812LD-30WR3			12	2500/0	86/88	2700
	VRB4815LD-30WR3			15	2000/0	87/89	1680
	VRB4824LD-30WR3			24	1250/0	87/89	680

Notes:

- ① Exceeding the maximum input voltage may cause permanent damage;
- ② Efficiency is measured at nominal input voltage and rated output load.

Input Specifications

Item	Operating Conditions	Min.	Typ.	Max.	Unit	
Input Current (full load / no-load)	24VDC nominal input series, nominal input voltage	3.3VDC output	--	1471/60	1507/100	mA
		5VDC output	--	1421/60	1453/100	
		Others	--	1389/6	1489/12	
Input Current (full load / no-load)	48VDC nominal input series, nominal input voltage	3.3VDC output	--	727/20	745/30	mA
		5VDC output	--	711/20	727/35	
		Others	--	711/5	727/10	
Reflected Ripple Current	Nominal input voltage	--	40	--		
Surge Voltage (1sec. max.)	24VDC nominal input series	-0.7	--	50	VDC	
	48VDC nominal input series	-0.7	--	100		
Start-up Voltage	24VDC nominal input series	--	--	18	VDC	
	48VDC nominal input series	--	--	36		
Start-up Time	Nominal input voltage & constant resistance load	--	10	--	ms	

Input Filter		PI filter			
Hot Plug		Unavailable			
Ctrl *	Module on	Ctrl pin open or pulled high (3.5-12VDC)			
	Module off	Ctrl pin pulled low to GND (0-1.2VDC)			
	Input current when off	--	5	8	mA

Note: *The Ctrl pin voltage is referenced to input GND.

Output Specifications

Item	Operating Conditions	Min.	Typ.	Max.	Unit
Voltage Accuracy	5%-100% load	--	±1	±3	%
	0%-5% load	--	±1	±5	
Linear Regulation	Input voltage variation from low to high at full load	--	±0.2	±0.5	
Load Regulation ^①	5%-100% load	--	±0.5	±1	
Transient Recovery Time		--	300	500	μs
Transient Response Deviation	25% load step change, nominal input voltage	3.3V/5VDC output		±8	%
		Others		±5	
Temperature Coefficient	Full load	--	--	±0.03	%/°C
Ripple & Noise ^②	20MHz bandwidth, nominal input voltage, 100% load	--	50	100	Mv p-p
Trim	Input voltage range	90	--	110	%Vo
Over-voltage Protection		110	--	160	
Over-current Protection		110	--	190	%Io
Short-circuit Protection		Hiccup, continuous, self-recovery			

Note: ①Load regulation for 0%-100% load is ±5%;
②The "parallel cable" method is used for Ripple and Noise test, please refer to DC-DC Converter Application Notes for specific information.

General Specifications

Item	Operating Conditions	Min.	Typ.	Max.	Unit
Isolation	Input-output Electric Strength test for 1 minute with a leakage current of 1mA max.	1500	--	--	VDC
Insulation Resistance	Input-output resistance at 500VDC/60sec.	1000	--	--	MΩ
Isolation Capacitance	Input-output capacitance at 100KHz/0.1V	--	2000	--	pF
Operating Temperature	See Fig. 1 and Fig. 2	-40	--	+80	°C
Storage Temperature		-55	--	+125	
Storage Humidity	Non-condensing	5	--	95	%RH
Pin Soldering Resistance Temperature	Soldering spot is 1.5mm away from case for 10 seconds	--	--	+300	°C
Vibration		10-55Hz, 2G, 30 Min. along X, Y and Z			
Switching Frequency *	PWM mode	--	300	--	KHz
MTBF	MIL-HDBK-217F@25°C	1000	--	--	K hours

Note: *Switching frequency is measured at full load. The module reduces the switching frequency for light load (below 50%) efficiency improvement.

Mechanical Specifications

Case Material	Aluminum alloy
Dimensions	50.80 x 25.40 x 11.80 mm
Weight	27.8g(Typ.)
Cooling Method	Free air convection

Electromagnetic Compatibility (EMC)

Emissions	CE	CISPR32/EN55032 CLASS A (without extra components)/ CLASS B (see Fig.4-② for recommended circuit)	
	RE	CISPR32/EN55032 CLASS A (without extra components)/ CLASS B (see Fig.4-② for recommended circuit)	
Immunity	ESD	IEC/EN61000-4-2	Contact ±4KV perf. Criteria B
	RS	IEC/EN61000-4-3	10V/m perf. Criteria A
	EFT	IEC/EN61000-4-4	±2KV (see Fig.4-① for recommended circuit) perf. Criteria B
	Surge	IEC/EN61000-4-5	line to line ±2KV (see Fig.4-① for recommended circuit) perf. Criteria B
	CS	IEC/EN61000-4-6	3 Vr.m.s perf. Criteria A

Typical Characteristic Curves

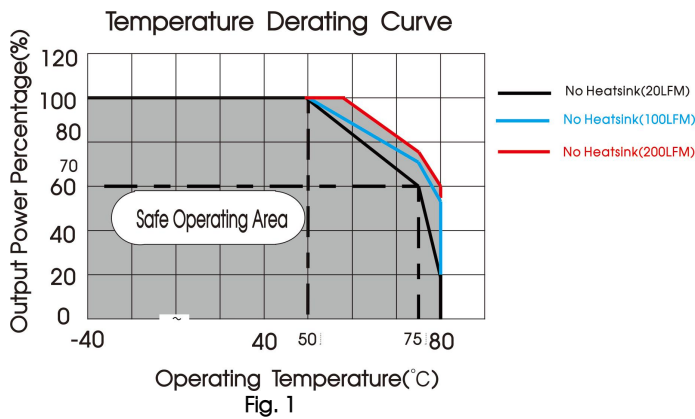

Apply model: VRB2403LD-30WR3、VRB2405LD-30WR3、
VRB4803LD-30WR3、VRB4805LD-30WR3

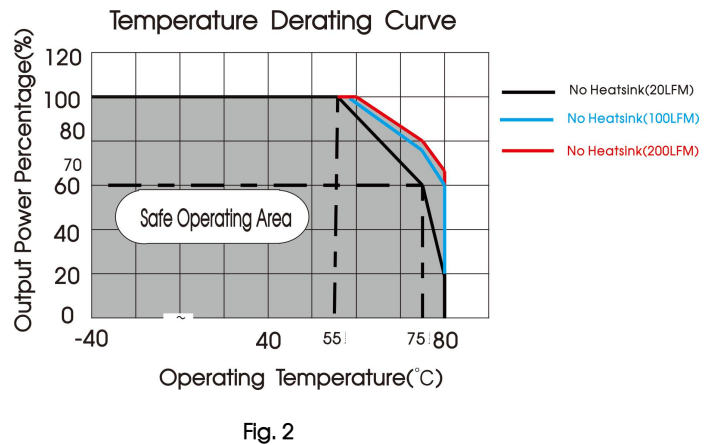

Apply model: VRB2409LD-30WR3、VRB2412LD-30WR3、
VRB2415LD-30WR3、VRB2424LD-30WR3、
VRB4812LD-30WR3、VRB4815LD-30WR3、
VRB4824LD-30WR3

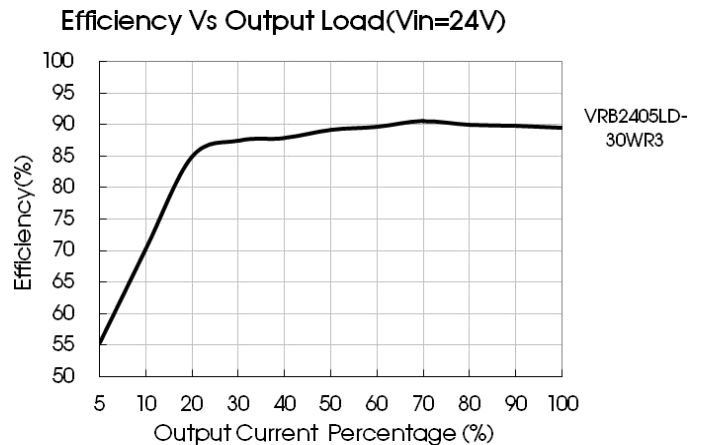
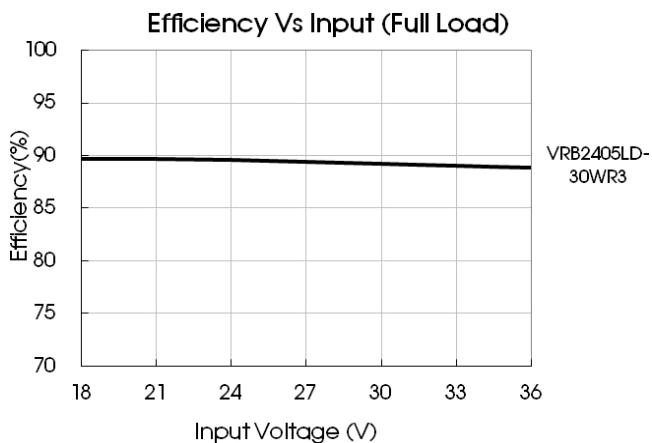

Design Reference

1. Typical application

All the DC/DC converters of this series are tested before delivery using the recommended circuit shown in Fig. 3.

Input and/or output ripple can be further reduced by appropriately increasing the input & output capacitor values C_{in} and C_{out} and/or by selecting capacitors with a low ESR (equivalent series resistance). Also make sure that the capacitance is not exceeding the specified max. capacitive load value of the product.



Fig. 3

output voltage (VDC)	Cout (μF)	Cin (μF)
3.3/5/9	220	100
12/15/24	100	

2. EMC compliance circuit

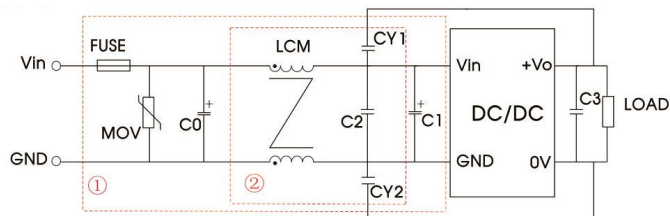

Fig. 4

Notes: For EMC tests we use Part ① in Fig. 4 for immunity and part ② for emissions test.

Parameter description

Model	Vin: 24V	Vin: 48V
FUSE	Choose according to actual input current	
MOV	S20K30	S14K60
C0	680μF/50V	330μF/100V
C1	330μF/50V	330μF/100V
C2	4.7μF/50V	2.2μF/100V
C3	Refer to the Cout in Fig.3	
LCM	1mH, recommended to use MORNSUN P/N: FL2D-30-102s	
CY1, CY2	1nF/2KV	

3. Trim Function for Output Voltage Adjustment (open if unused)

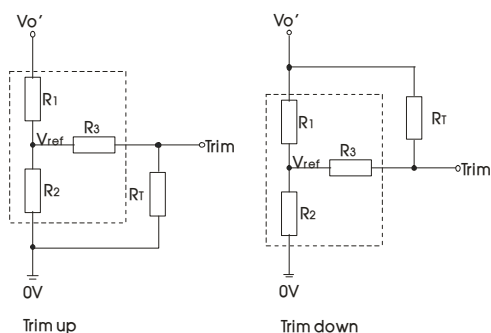

Calculating Trim resistor values:

$$\text{up: } R_T = \frac{\alpha R_2}{R_2 - \alpha} - R_3 \quad \alpha = \frac{V_{ref}}{V_o' - V_{ref}} \cdot R_1$$

$$\text{down: } R_T = \frac{\alpha R_1}{R_1 - \alpha} - R_3 \quad \alpha = \frac{V_o' - V_{ref}}{V_{ref}} \cdot R_2$$

R_T = Trim resistance;
 α = self-defined parameter;
 V_o' = desired output voltage.

TRIM resistor connection (dashed line shows internal resistor network)

Vout(VDC)	R1(KΩ)	R2(KΩ)	R3(KΩ)	Vref(V)
3.3	4.801	2.87	12.4	1.24
5	2.883	2.87	10	2.5
9	7.500	2.87	15	2.5
12	11.000	2.87	15	2.5
15	14.494	2.87	15	2.5
24	24.872	2.87	17.8	2.5

4. The products do not support parallel connection of their output

5. For additional information please refer to DC-DC converter application notes on www.mornsun-power.com

Horizontal Package Dimensions and Recommended Layout

THIRD ANGLE PROJECTION

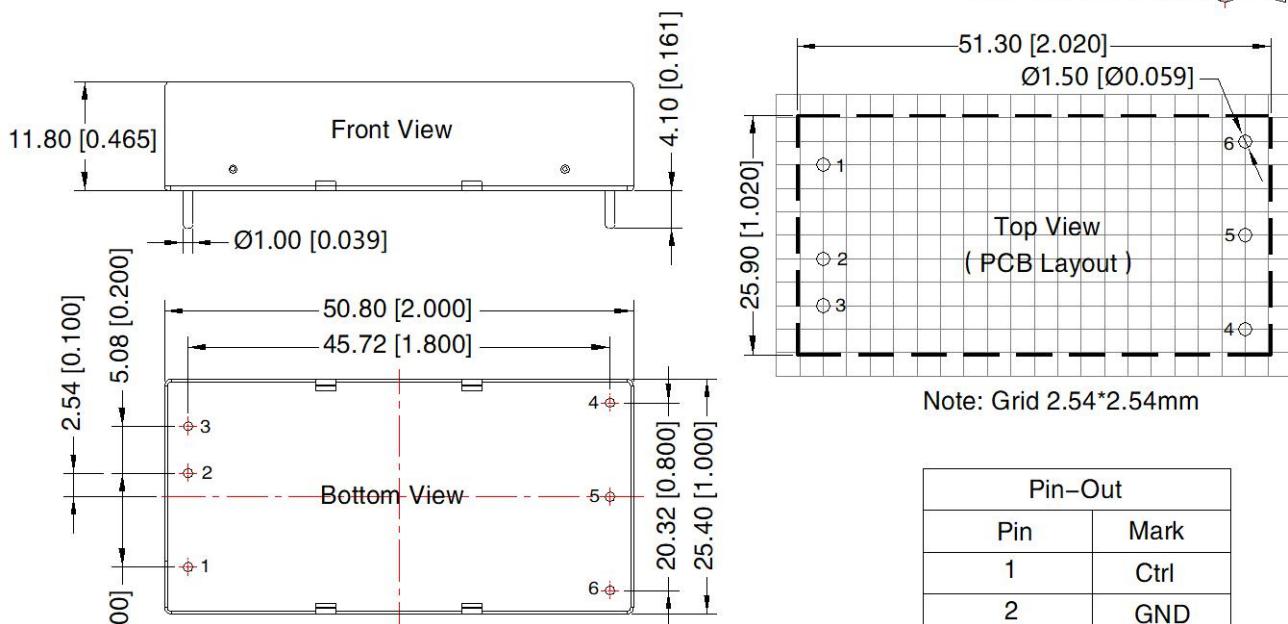

Note:
Unit: mm[inch]
Pin diameter tolerances: ± 0.10 [± 0.004]
General tolerances: ± 0.50 [± 0.020]

Pin-Out	
Pin	Mark
1	Ctrl
2	GND
3	Vin
4	+Vo
5	0V
6	Trim

Notes:

- For additional information on Product Packaging please refer to www.mornsun-power.com. Horizontal Packaging Bag Number: 58200035;
- The maximum capacitive load offered were tested at input voltage range and full load;
- Unless otherwise specified, parameters in this datasheet were measured under the conditions of $T_a=25^\circ\text{C}$, humidity<75%RH with nominal input voltage and rated output load;
- All index testing methods in this datasheet are based on company corporate standards;
- We can provide product customization service, please contact our technicians directly for specific information;
- Products are related to laws and regulations: see "Features" and "EMC";
- Our products shall be classified according to ISO14001 and related environmental laws and regulations, and shall be handled by qualified units.

Mornsun Guangzhou Science & Technology Co., Ltd.

Address: No. 5, Kehui St. 1, Kehui Development Center, Science Ave., Guangzhou Science City, Huangpu District, Guangzhou, P. R. China
Tel: 86-20-38601850 Fax: 86-20-38601272 E-mail: info@mornsun.cn www.mornsun-power.com