

# BL02RN2R1M2#

“#” indicates a package specification code.



< List of part numbers with package codes >  
BL02RN2R1M2B

## Appearance & Shape

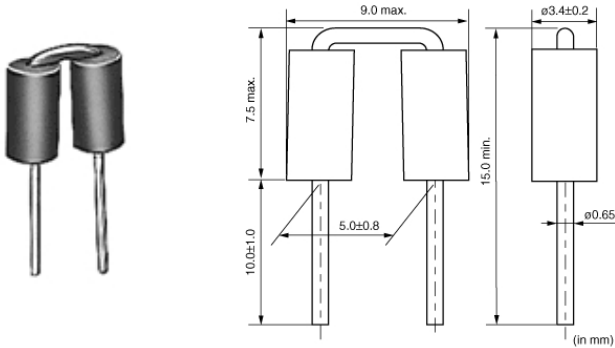

## Features

BL01/02/03 series are ferrite beads with lead wires to produce a high frequency loss for suppression of noise. Simple construction and easy-to-use, effective for low impedance circuits such as power supplies and grounds. Effective also for preventing overshoot and undershoot of digital signal in clocks or the like, and suppressing the higher harmonic wave. Suitable for prevention of abnormal oscillation at high frequency amplifying circuit.

## Applications

Other Usage	For general
-------------	-------------

## Packaging Information

Packaging	Specifications	Standard Packing Quantity
B	Bulk(Bag)	500

**Attention**  
 1.This datasheet is downloaded from the website of Murata Manufacturing Co., Ltd. Therefore, it's specifications are subject to change or our products in it may be discontinued without advance notice. Please check with our sales representatives or product engineers before ordering.  
 2.This datasheet has only typical specifications because there is no space for detailed specifications.  
 Therefore, please review our product specifications or consult the approval sheet for product specifications before ordering.

# BL02RN2R1M2#

“#” indicates a package specification code.

## Specifications

Shape	Lead
Length	9.0mm
Length Tolerance	max.
Width	3.4mm
Width Tolerance	±0.2mm
Thickness	7.5mm
Thickness Tolerance	max.
Operating Temperature Range	-40°C to 85°C
Mass(typ.)	0.57g
Number of Circuit	1
Rated Current (at 85°C)	7A

### Attention

- 1.This datasheet is downloaded from the website of Murata Manufacturing Co., Ltd. Therefore, it's specifications are subject to change or our products in it may be discontinued without advance notice. Please check with our sales representatives or product engineers before ordering.
- 2.This datasheet has only typical specifications because there is no space for detailed specifications.  
Therefore, please review our product specifications or consult the approval sheet for product specifications before ordering.

# BL02RN2R1M2#

“#” indicates a package specification code.

## Product Data

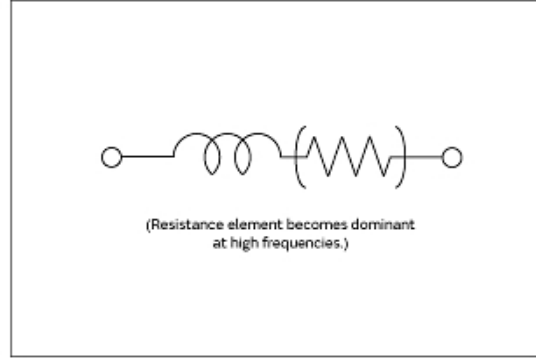
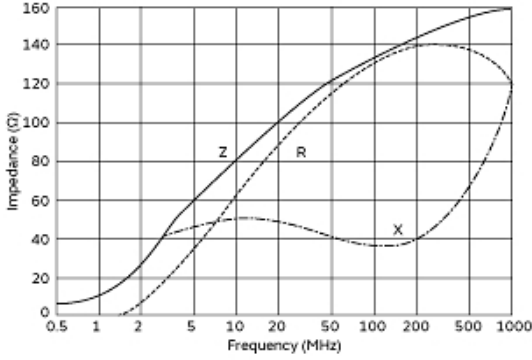

Impedance-Frequency Characteristics

Equivalent Circuit

**Attention**

- 1.This datasheet is downloaded from the website of Murata Manufacturing Co., Ltd. Therefore, it's specifications are subject to change or our products in it may be discontinued without advance notice. Please check with our sales representatives or product engineers before ordering.
- 2.This datasheet has only typical specifications because there is no space for detailed specifications. Therefore, please review our product specifications or consult the approval sheet for product specifications before ordering.